

Table of Contents

Introduction	4
Instrument Cluster	14
Warning lights and chimes	14
Gauges	21
Message center	22
Entertainment Systems	60
AM/FM stereo	60
AM/FM stereo with CD	62
Auxiliary input jack	69
USB port	71
Satellite radio information	74
Navigation system	77
SYNC®	77
Climate Controls	78
Manual heating and air conditioning	78
Dual electronic automatic temperature control	81
Rear window defroster	84
Lights	86
Headlamps	86
Turn signal control	90
Bulb replacement	91
Driver Controls	97
Windshield wiper/washer control	97
Steering wheel adjustment	98
Power windows	102
Mirrors	104
Speed control	109
Upfitter controls	112
Locks and Security	126
Keys	126
Locks	134
Anti-theft system	146

Table of Contents

Seating and Safety Restraints 150

Seating	150
Safety restraints	166
Airbags	176
Child restraints	190

Tires, Wheels and Loading 212

Tire information	214
Tire inflation	217
Tire Pressure Monitoring System (TPMS)	232
Vehicle loading	239
Trailer towing	247
Trailer brake controller-integrated	251
Recreational towing	258

Driving 259

Starting	259
Brakes	265
Traction Control™	267
AdvanceTrac®	268
Hill descent control	275
Transmission operation	281
Reverse sensing system	289
Rear-view camera system	291

Roadside Emergencies 311

Getting roadside assistance	311
Hazard flasher control	312
Fuel pump shut-off	313
Fuses and relays	313
Changing tires	323
Wheel lug nut torque	339
Jump starting	340
Wrecker towing	343

Customer Assistance 345

Reporting safety defects (U.S. only)	351
Reporting safety defects (Canada only)	351

Table of Contents

Cleaning	352
Maintenance and Specifications	361
Engine compartment	362
Engine oil	366
Battery	368
Engine coolant	370
Fuel information	377
Air filter(s)	395
Part numbers	399
Maintenance product specifications and capacities	400
Engine data	404
Accessories	408
Ford Extended Service Plan	411
Scheduled Maintenance Guide	415
Normal scheduled maintenance and log	419
Index	435

All rights reserved. Reproduction by any means, electronic or mechanical including photocopying, recording or by any information storage and retrieval system or translation in whole or part is not permitted without written authorization from Ford Motor Company. Ford may change the contents without notice and without incurring obligation.

Copyright © 2009 Ford Motor Company

Introduction

CONGRATULATIONS

Congratulations on acquiring your new Ford. Please take the time to get well acquainted with your vehicle by reading this handbook. The more you know and understand about your vehicle, the greater the safety and pleasure you will derive from driving it.

For more information on Ford Motor Company and its products visit the following website:

- In the United States: www.ford.com
- In Canada: www.ford.ca
- In Australia: www.ford.com.au
- In Mexico: www.ford.com.mx

Additional owner information is given in separate publications.

This Owner's Guide describes every option and model variant available and therefore some of the items covered may not apply to your particular vehicle. Furthermore, due to printing cycles it may describe options before they are generally available.

Remember to pass on this Owner's Guide when reselling the vehicle. It is an integral part of the vehicle.



WARNING: Fuel pump shut-off switch: In the event of an accident the safety switch will automatically cut off the fuel supply to the engine. The switch can also be activated through sudden vibration (e.g. collision when parking). To reset the switch, refer to the *Fuel pump shut-off switch* in the *Roadside Emergencies* chapter.

Introduction

SAFETY AND ENVIRONMENT PROTECTION

Warning symbols in this guide

How can you reduce the risk of personal injury to yourself or others? In this guide, answers to such questions are contained in comments highlighted by the warning triangle symbol. These comments should be read and observed.

Warning symbols on your vehicle

When you see this symbol, it is imperative that you consult the relevant section of this guide before touching or attempting adjustment of any kind.



Protecting the environment

We must all play our part in protecting the environment. Correct vehicle usage and the authorized disposal of waste, cleaning and lubrication materials are significant steps towards this aim. Information in this respect is highlighted in this guide with the tree symbol.



CALIFORNIA Proposition 65 Warning

 **WARNING:** Engine exhaust, some of its constituents, and certain vehicle components contain or emit chemicals known to the State of California to cause cancer and birth defects or other reproductive harm. In addition, certain fluids contained in vehicles and certain products of component wear contain or emit chemicals known to the State of California to cause cancer and birth defects or other reproductive harm.

PERCHLORATE MATERIAL

Certain components of this vehicle such as airbag modules, seat belt pretensioners, and button cell batteries may contain Perchlorate Material – Special handling may apply for service or vehicle end of life disposal. See www.dtsc.ca.gov/hazardouswaste/perchlorate.

Introduction

BREAKING-IN YOUR VEHICLE

Your vehicle does not need an extensive break-in. Try not to drive continuously at the same speed for the first 1,000 miles (1,600 km) of new vehicle operation. Vary your speed frequently in order to give the moving parts a chance to break in.

Drive your new vehicle at least 1,000 miles (1,600 km) before towing a trailer. For more detailed information about towing a trailer, refer to *Trailer towing* in the *Tires, Wheels and Loading* chapter.

Do not add friction modifier compounds or special break-in oils since these additives may prevent piston ring seating. See *Engine oil* in the *Maintenance and Specifications* chapter for more information on oil usage.

SPECIAL NOTICES

New Vehicle Limited Warranty

For a detailed description of what is covered and what is not covered by your vehicle's New Vehicle Limited Warranty, refer to the *Warranty Guide* that is provided to you along with your Owner's Guide.

Special instructions

For your added safety, your vehicle is fitted with sophisticated electronic controls.



WARNING: Please read the section *Airbag Supplemental Restraint System (SRS)* in the *Seating and Safety Restraints* chapter. Failure to follow the specific warnings and instructions could result in personal injury.



WARNING: Front seat mounted rear-facing child or infant seats should **NEVER** be placed in front of an active passenger airbag.

Notice to owners of diesel-powered vehicles

Read the diesel supplement for information regarding correct operation and maintenance of your Diesel-powered light truck.

Introduction

Notice to owners of pickup trucks and utility type vehicles



WARNING: Utility vehicles have a significantly higher rollover rate than other types of vehicles.

Before you drive your vehicle, please read this Owner's Guide carefully. Your vehicle is not a passenger car. As with other vehicles of this type, failure to operate this vehicle correctly may result in loss of vehicle control, vehicle rollover, personal injury or death.

Using your vehicle with a snowplow

For more information and guidelines for using your vehicle with a snowplow, refer to the *Driving* chapter.

Using your vehicle as an ambulance

If your light truck is equipped with the Ford Ambulance Preparation Package, it may be utilized as an ambulance. Ford urges ambulance manufacturers to follow the recommendations of the *Ford Incomplete Vehicle Manual*, *Ford Truck Body Builder's Layout Book* and the *Qualified Vehicle Modifiers (QVM) Guidelines* as well as pertinent supplements. For additional information, please contact the Truck Body Builders Advisory Service at <http://www.fleet.ford.com/truckbbas/> and then by selecting "Contact Us" or by phone at 1-877-840-4338.

Use of your Ford light truck as an ambulance, without the Ford Ambulance Preparation Package voids the Ford New Vehicle Limited Warranty and may void the Emissions Warranties. In addition, ambulance usage without the preparation package could cause high underbody temperatures, overpressurized fuel and a risk of spraying fuel which could lead to fires.

If your vehicle is equipped with the Ford Ambulance Preparation Package, it will be indicated on the Safety Compliance Certification Label. The label is located on the driver's side door pillar or on the rear edge of the driver's door. You can determine whether the ambulance manufacturer followed Ford's recommendations by directly contacting that manufacturer. Ford Ambulance Preparation Package is only available on certain Diesel engine equipped vehicles.

Using your vehicle as a stationary power source (PTO)

Refer to the *Driving* chapter for more information and guidelines for operating a vehicle equipped with an aftermarket power take-off system.

Introduction

DATA RECORDING

Service Data Recording

Service data recorders in your vehicle are capable of collecting and storing diagnostic information about your vehicle. This potentially includes information about the performance or status of various systems and modules in the vehicle, such as engine, throttle, steering or brake systems. In order to properly diagnose and service your vehicle, Ford Motor Company, Ford of Canada, and service and repair facilities may access or share among them vehicle diagnostic information received through a direct connection to your vehicle when diagnosing or servicing your vehicle. For U.S. only (if equipped), if you choose to use the SYNC® Vehicle Health Report, you consent that certain diagnostic information may also be accessed electronically by Ford Motor Company and Ford authorized service facilities, and that the diagnostic information may be used for any purpose. See your SYNC® supplement for more information.

Event Data Recording

This vehicle is equipped with an event data recorder (EDR). The main purpose of an EDR is to record, in certain crash or near crash-like situations, such as an airbag deployment or hitting a road obstacle; this data will assist in understanding how a vehicle's systems performed. The EDR is designed to record data related to vehicle dynamics and safety systems for a short period of time, typically 30 seconds or less. The EDR in this vehicle is designed to record such data as:

- How various systems in your vehicle were operating;
- Whether or not the driver and passenger seatbelts were buckled/fastened;
- How far (if at all) the driver was depressing the accelerator and/or the brake pedal; and
- How fast the vehicle was travelling; and
- Where the driver was positioning the steering wheel.

This data can help provide a better understanding of the circumstances in which crashes and injuries occur.

Note: EDR data is recorded by your vehicle only if a non-trivial crash situation occurs; no data is recorded by the EDR under normal driving conditions and no personal data or information (e.g., name, gender, age, and crash location) is recorded (see

8

Introduction

limitations regarding 911 Assist and Traffic, directions and Information privacy below). However, parties, such as law enforcement, could combine the EDR data with the type of personally identifying data routinely acquired during a crash investigation.

To read data recorded by an EDR, special equipment is required, and access to the vehicle or the EDR is needed. In addition to the vehicle manufacturer, other parties, such as law enforcement, that have such special equipment, can read the information if they have access to the vehicle or the EDR. Ford Motor Company and Ford of Canada do not access event data recorder information without obtaining consent, unless pursuant to court order or where required by law enforcement, other government authorities or other third parties acting with lawful authority. Other parties may seek to access the information independently of Ford Motor Company and Ford of Canada.

Note: Including to the extent that any law pertaining to Event Data Recorders applies to SYNC® or its features, please note the following: Once 911 Assist (if equipped) is enabled (set ON), 911 Assist may, through any paired and connected cell phone, disclose to emergency services that the vehicle has been in a crash involving the deployment of an airbag or, in certain vehicles, the activation of the fuel pump shut-off. Certain versions or updates to 911 Assist may also be capable of being used to electronically or verbally provide to 911 operators the vehicle location (such as latitude and longitude), and/or other details about the vehicle or crash or personal information about the occupants to assist 911 operators to provide the most appropriate emergency services. If you do not want to disclose this information, do not activate the 911 Assist feature. See your SYNC® supplement for more information.

Additionally, when you connect to Traffic, Directions and Information (if equipped, U.S. only) the service uses GPS technology and advanced vehicle sensors to collect the vehicle's current location, travel direction, and speed ("vehicle travel information") only to help provide you with the directions, traffic reports, or business searches your request. If you do not want Ford or its vendors to receive this information, do not activate the service. Ford Motor Company and the vendors it uses to provide you with this information do not store your vehicle travel information. For more information, see Traffic, Directions and Information, Terms and Conditions. See your SYNC® supplement for more information.

Introduction

Vehicle Modification Data Recording

Some aftermarket products may cause severe engine and/or transmission damage; refer to the *What is not covered* section in *The new vehicle limited warranty for your vehicle* chapter of your vehicle's *Warranty Guide* for more information. Some vehicles are equipped with Powertrain Control Systems that can detect and store information about vehicle modifications that, for example, increase horsepower and torque output; this information cannot be erased and will stay in the system's memory even if the modification is removed. When a dealer or repair facility works on your vehicle, it may be necessary for them to access the information in the Powertrain Control System. This information will likely identify if any unauthorized modifications have been made to the system, which may be used to determine if the warranty has been violated and if repairs will be covered by warranty.

CELL PHONE USE

The use of Mobile Communications Equipment has become increasingly important in the conduct of business and personal affairs. However, drivers must not compromise their own or others' safety when using such equipment. Mobile Communications can enhance personal safety and security when appropriately used, particularly in emergency situations. Safety must be paramount when using mobile communications equipment to avoid negating these benefits.

Mobile Communication Equipment includes, but is not limited to, cellular phones, pagers, portable email devices, text messaging devices and portable two-way radios.



WARNING: Driving while distracted can result in loss of vehicle control, accident and injury. Ford strongly recommends that you use extreme caution when using any device or feature that may take your focus off the road. Your primary responsibility is the safe operation of your vehicle.

We recommend against the use of any handheld device while driving and that you comply with all applicable laws.

Introduction



















EXPORT UNIQUE (NON-UNITED STATES/CANADA) VEHICLE SPECIFIC INFORMATION

For your particular global region, your vehicle may be equipped with features and options that are different from the features and options that are described in this Owner's Guide. A market unique supplement may be supplied that complements this book. By referring to the market unique supplement, if provided, you can properly identify those features, recommendations and specifications that are unique to your vehicle. This Owner's Guide is written primarily for the U.S. and Canadian Markets. Features or equipment listed as standard may be different on units built for Export. **Refer to this Owner's Guide for all other required information and warnings.**

Introduction





















These are some of the symbols you may see on your vehicle.

Vehicle Symbol Glossary

Safety Alert		See Owner's Guide	
Fasten Safety Belt		Airbag - Front	
Airbag - Side		Child Seat Lower Anchor	
Child Seat Tether Anchor		Brake System	
Anti-Lock Brake System		Parking Brake System	
Brake Fluid - Non-Petroleum Based		Parking Aid System	
Stability Control System		Speed Control	
Master Lighting Switch		Hazard Warning Flasher	
Fog Lamps-Front		Fuse Compartment	
Fuel Pump Reset		Windshield Wash/Wipe	
Windshield Defrost/Demist		Rear Window Defrost/Demist	

Introduction

Vehicle Symbol Glossary

Power Windows Front/Rear		Power Window Lockout	
Child Safety Door Lock/Unlock		Interior Luggage Compartment Release	
Panic Alarm		Engine Oil	
Engine Coolant		Engine Coolant Temperature	
Do Not Open When Hot		Battery	
Avoid Smoking, Flames, or Sparks		Battery Acid	
Explosive Gas		Fan Warning	
Power Steering Fluid		Maintain Correct Fluid Level	
Service Engine Soon		Engine Air Filter	
Passenger Compartment Air Filter		Jack	
Check Fuel Cap		Low Tire Pressure Warning	

Instrument Cluster

WARNING LIGHTS AND CHIMES

Base instrument cluster with standard measure shown; metric similar

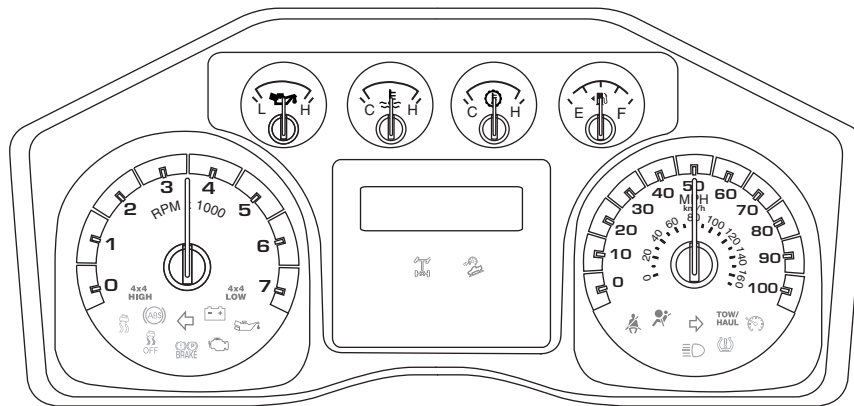

Optional instrument cluster with standard measure shown; metric similar

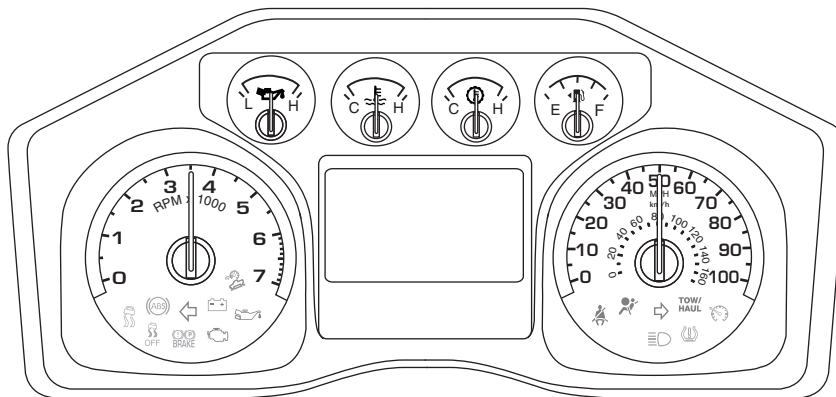

Warning lights and gauges can alert you to a vehicle condition that may become serious enough to cause expensive repairs. A warning light may illuminate when a problem exists with one of your vehicle's functions. Many lights will illuminate when you start your vehicle to make sure the

14

Instrument Cluster

bulb works. If any light remains on after starting the vehicle, refer to the respective system warning light for additional information.

Standard message center

Note: Some warning lights are reconfigurable telltale (RTT) indicator lights and will illuminate in the message center. These lights function the same as the other warning lights.

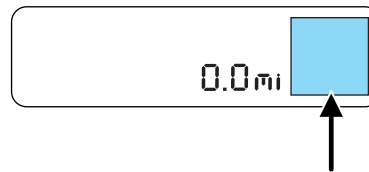

Optional message center

Note: Some warning lights are reconfigurable telltale (RTT) indicator lights and will illuminate in the message center. These lights function the same as the other warning lights. The first three positions will only display one warning telltale at a time; the last three positions can cycle between different warning telltales.

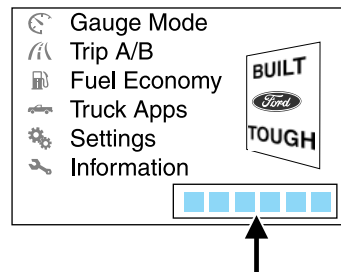

Service engine soon:

The service engine soon indicator  illuminates when the ignition is first turned to the on position to check the bulb and to indicate whether the vehicle is ready for Inspection/Maintenance (I/M) testing. Normally, the service engine soon indicator will stay on until the engine is cranked, then turn itself off if no malfunctions are present. However, if after 15 seconds the service engine soon indicator blinks eight times, it means that the vehicle is not ready for I/M testing. See the *Readiness for Inspection/Maintenance (I/M) testing* in the *Maintenance and Specifications* chapter.

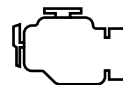

Solid illumination after the engine is started indicates the On Board Diagnostics System (OBD-II) has detected a malfunction. Refer to *On board diagnostics (OBD-II)* in the *Maintenance and Specifications* chapter. If the light is blinking, engine misfire is occurring which could damage your catalytic converter. Drive in a moderate fashion (avoid heavy acceleration and deceleration) and have your vehicle serviced immediately by your authorized dealer.

Instrument Cluster

 **WARNING:** Under engine misfire conditions, excessive exhaust temperatures could damage the catalytic converter, the fuel system, interior floor coverings or other vehicle components, possibly causing a fire.

Check fuel cap: Displays when the fuel cap may not be properly installed. Continued driving with this light on may cause the Service engine soon warning indicator to come on. Refer to *Fuel filler cap* in the *Maintenance and Specifications* chapter.



Low fuel (RTT): Displays when the fuel level in the fuel tank is at or near empty (refer to *Fuel gauge* in this chapter).



Powertrain malfunction/Reduced power/Electronic throttle control (RTT):

Displays when the engine has defaulted to a “limp-home” operation or when a transmission problem has been detected and shifting may be restricted. If the light remains on, have the system serviced immediately by your authorized dealer.



Brake system warning light: To confirm the brake system warning light is functional, it will momentarily illuminate when the ignition is turned to the on position when the engine is not running, or in a position between on and start, or by applying the parking brake when the ignition is turned to the on position.

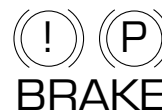

If the brake system warning light does not illuminate at this time, seek service immediately from your authorized dealer. Illumination after releasing the parking brake indicates low brake fluid level and the brake system should be inspected immediately by your authorized dealer.

Instrument Cluster



WARNING: Driving a vehicle with the brake system warning light on is dangerous. A significant decrease in braking performance may occur. It will take you longer to stop the vehicle. Have the vehicle checked by your authorized dealer. Driving extended distances with the parking brake engaged can cause brake failure and the risk of personal injury.

Anti-lock brake system: If the ABS light stays illuminated or continues to flash, a malfunction has been detected, have the system serviced immediately by your authorized dealer. Normal braking is still functional unless the brake warning light also is illuminated.

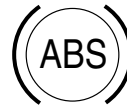

Airbag readiness: If this light fails to illuminate when the ignition is turned to on, continues to flash or remains on, have the system serviced immediately by your authorized dealer. A chime will sound if there is a malfunction in the indicator light.



Safety belt: Reminds you to fasten your safety belt. A Belt-Minder® chime will also sound to remind you to fasten your safety belt. Refer to the *Seating and Safety Restraints* chapter to activate/deactivate the Belt-Minder® chime feature.



Charging system: Illuminates when the battery is not charging properly. If it stays on while the engine is running, there may be a malfunction with the charging system. Contact your authorized dealer as soon as possible. This indicates a problem with the electrical system or a related component.



Engine oil pressure (RTT and static warning light): Displays when the oil pressure falls below the normal range. Refer to *Engine oil* in the *Maintenance and Specifications* chapter.



Instrument Cluster

Door ajar (RTT): Displays when the ignition is in the on position and any door is open.



Engine coolant temperature (RTT): Illuminates when the engine coolant temperature is high. Stop the vehicle as soon as possible, switch off the engine and let cool. Refer to *Engine coolant* in the *Maintenance and Specifications* chapter.



WARNING: Never remove the coolant reservoir cap while the engine is running or hot.

Low tire pressure warning (if equipped): Illuminates when your tire pressure is low. If the light remains on at start up or while driving, the tire pressure should be checked. Refer to *Inflating your tires* in the *Tires, Wheels and Loading* chapter. When the ignition is first turned to on, the light will illuminate for three seconds to ensure the bulb is working. If the light does not turn on, have the system inspected by your authorized dealer. For more information on this system, refer to *Tire pressure monitoring system (TPMS)* in the *Tires, Wheels and Loading* chapter.

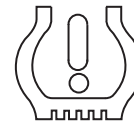

Hill descent (if equipped): Displays when using the hill descent mode. Refer to the *Driving* chapter for transmission function and operation.

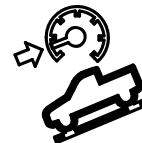

Transmission Tow/Haul Feature (if equipped): Displays when the Tow/Haul feature has been activated. Refer to the *Driving* chapter for transmission function and operation. If the light flashes steadily, have the system serviced immediately, damage to the transmission could occur.

**TOW
HAUL**

Instrument Cluster

AdvanceTrac®/Traction control (if equipped):

Displays when the AdvanceTrac®/Traction control is active. If the light remains on, have the system serviced immediately, refer to the *Driving* chapter for more information.



AdvanceTrac®/Traction control off light (if equipped): Illuminates when AdvanceTrac®/Traction control has been disabled by the driver. Refer to the *Driving* chapter for more information.



4X2 (RTT) (if equipped):

Displays momentarily when two-wheel drive high is selected. If the light fails to display when the ignition is turned on, or remains on, have the system serviced immediately by your authorized dealer.

4x2

Four wheel drive low (RTT and static) (if equipped):

Displays when four-wheel drive low is engaged. If the light fails to display when the ignition is turned on, or remains on, have the system serviced immediately by your authorized dealer.

4x4
LOW

Four wheel drive high (RTT and static) (if equipped):

Displays when four-wheel drive high is engaged. If the light fails to display when the ignition is turned on, or remains on, have the system serviced immediately by your authorized dealer.

4x4
HIGH

Electronic locking differential (RTT and static) (if equipped):

Displays when using the electronic locking differential.



Instrument Cluster

Speed control (if equipped): The speed control system indicator light changes color to indicate what mode the system is in:

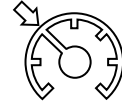

- **On (amber light):** Illuminates when the speed control system is turned on. Turns off when the speed control system is engaged or turned off.
- **Engaged (green light):** Illuminates when the speed control system is engaged. Turns off when the speed control system is disengaged.

Turn signal: Illuminates when the left or right turn signal or the hazard lights are turned on. If the indicators stay on or flash faster, check for a burned out bulb.



High beams: Illuminates when the high-beam headlamps are turned on.



Diesel warning lights: If your vehicle is equipped with a diesel engine, it has some unique warning lights; refer to *Instrument Cluster* in your diesel supplement for detailed information on their function.

- Glow plug pre-heat
- Water in fuel
- Diesel exhaust fluid



Key-in-ignition warning chime: Sounds when the key is left in the ignition in the off or accessory position and the driver's door is opened.

Headlamps on warning chime: Sounds when the headlamps or parking lamps are on, the ignition is off (the key is not in the ignition) and the driver's door is opened.

20

Instrument Cluster

GAUGES

Base cluster with automatic transmission shown. Metric similar.

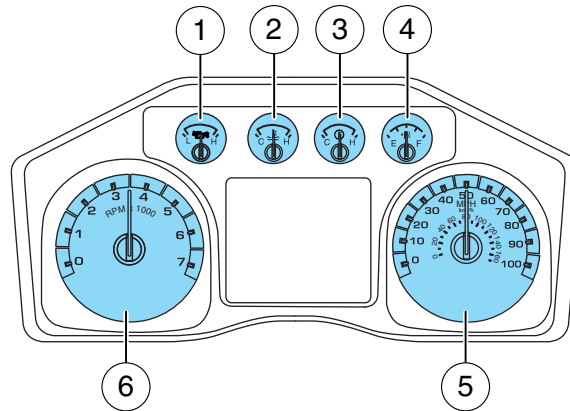

1. **Engine oil pressure gauge:** Indicates engine oil pressure. The needle should stay in the normal operating range (between L and H). If the needle falls below the normal range, stop the vehicle, turn off the engine and check the engine oil level. Add oil if needed. If the oil level is correct, have your vehicle checked at your authorized dealer.

2. **Engine coolant temperature gauge:** Indicates engine coolant temperature. At normal operating temperature, the needle will be in the normal range (between H and C). **If it enters the red section, the engine is overheating. Stop the vehicle as soon as safely possible, switch off the engine and let the engine cool.**



WARNING: Never remove the coolant reservoir cap while the engine is running or hot.

3. **Transmission fluid temperature gauge:** If the gauge is in the:

Normal area The transmission fluid is within the normal operating temperature (between H and C).

Yellow area The transmission fluid is higher than normal operating temperature. This can be caused by special operation conditions (i.e. snowplowing, towing or off road use). Refer to *Special operating conditions* in the *scheduled maintenance information* for instructions. Operating the transmission for extended periods of time with the gauge in the yellow area may cause internal transmission damage.

Instrument Cluster

Altering the severity of the driving conditions is recommended to lower the transmission temperature into the normal range.

Red area The transmission fluid is overheating. Stop the vehicle to allow the temperature to return to normal range.

If the gauge is operating in the yellow or red area, stop the vehicle and verify the airflow is not restricted such as snow or debris blocking airflow through the grill. If the gauge continues to show high temperatures, see your authorized dealer.

4. **Fuel gauge:** Indicates approximately how much fuel is left in the fuel tank (when the ignition is in the on position). The fuel gauge may vary slightly when the vehicle is in motion or on a grade. The fuel icon and arrow indicates which side of the vehicle the fuel filler door is located.

Refer to *Filling the tank* in the *Maintenance and Specifications* chapter for more information.

5. **Speedometer:** Indicates the current vehicle speed.

6. **Tachometer:** Indicates the engine speed in revolutions per minute. Driving with your tachometer pointer continuously at the top of the scale may damage the engine.

Odometer and trip odometer: The odometer is displayed on the lower line in the message center and registers the total accumulated distance the vehicle has traveled. For trip odometer, refer to *Standard message center* or *Optional message center* in this chapter.

STANDARD MESSAGE CENTER

Your vehicle's message center is capable of monitoring many vehicle systems and will alert you to potential vehicle problems and various conditions with an informational message followed by a long indicator chime.

The message center display is located in the instrument cluster and the controls are located on the steering wheel.

Instrument Cluster

Selectable features

Info (information menu)

Press the INFO button repeatedly to cycle through the following features:

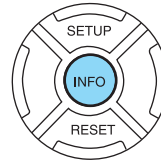

TRIP A/B

Registers the distance of individual journeys. Press and release the INFO button until the TRIP A/B appear in the display (this represents the trip mode). Press and hold the RESET button for two seconds to reset.

Refer to *UNITS* later in this section to switch the display from Metric to English.

XXX° (outside air temperature) (if equipped)

This displays the outside temperature.

Refer to *UNITS* later in this section to switch the display from Metric to English.

MYKEY MILES (km) (if programmed)

For more information, refer to *MyKey™* in the *Locks and Security* chapter.

XXX MILES (km) TO E

This displays an estimate of approximately how far you can drive with the fuel remaining in your tank under normal driving conditions. Remember to turn the ignition off when refueling to allow this feature to correctly detect the added fuel.

The low fuel indicator will illuminate when the fuel level is at approximately 1/16 of the tank.

DTE is calculated using a running average fuel economy, which is based on your recent driving history of 500 miles (800 km). This value is not the same as the average fuel economy display. The running average fuel economy is re-initialized to a factory default value if the battery is disconnected.

Instrument Cluster

XX.X AVG MPG (L/100km)

Average fuel economy displays your average fuel economy in miles/gallon or liters/100 km.

If you calculate your average fuel economy by dividing distance traveled by gallons of fuel used (liters of fuel used by 100 kilometers traveled), your figure may be different than displayed for the following reasons:

- Your vehicle was not perfectly level during fill-up
- Differences in the automatic shut-off points on the fuel pumps at service stations
- Variations in top-off procedure from one fill-up to another
- Rounding of the displayed values to the nearest 0.1 gallon (liter)

1. Drive the vehicle at least 5 miles (8 km) with the speed control system engaged to display a stabilized average.

2. Record the highway fuel economy for future reference.

It is important to press the RESET button (press and hold RESET for two seconds in order to reset the function) after setting the speed control to get accurate highway fuel economy readings.

MPG (L/km) ↑ ↓

This displays instantaneous fuel economy as a bar graph ranging from ↓ poor economy to ↑ excellent economy.

Your vehicle must be moving to calculate instantaneous fuel economy. When your vehicle is not moving, this function shows ↓, one or no bars illuminated. Instantaneous fuel economy cannot be reset.

TIMER

Timer displays the trip elapsed drive time.

To operate, do the following:

1. Press and release RESET in order to start the timer.
2. Press and release RESET to pause the timer.
3. Press and hold RESET until the timer resets.

TBC GAIN (if equipped)

Displays the level of trailer brake gain or if the trailer is not connected.

24

Instrument Cluster

System check and vehicle feature customization

Press the SETUP button repeatedly to cycle the message center through the following features:

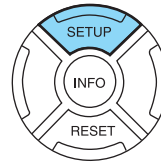

Note: When returning to the SETUP menu and a non-English language has been selected, HOLD RESET FOR ENGLISH will be displayed to change back to English. Press and hold the RESET button to change back to English.

RESET FOR SYSTEM CHECK

When this message appears, press the RESET button and the message center will begin to cycle through the following systems and provide a status of the item if needed.

1. OIL LIFE
2. EXHAUST FLUID LEVEL (Diesel only)
3. ENGINE HOURS
4. ENGINE IDLE HOURS (Diesel engine only)
5. CHARGING SYSTEM
6. DOOR
7. BRAKE SYSTEM
8. TBC GAIN = XX.X (if equipped)
9. FUEL LEVEL
10. MYKEY DISTANCE (if MyKey™ is programmed)
11. MYKEY(S) PROGRAMMED
12. ADMIN KEYS PROGRAMMED

Note: Some systems show a message only if a condition is present.

OIL LIFE

This displays the remaining oil life.

An oil change is required whenever indicated by the message center and according to the recommended maintenance schedule.

Instrument Cluster

To reset the oil monitoring system to 100% after each oil change, perform the following:

1. Press and release the SETUP button to display “OIL LIFE XXX% HOLD RESET = NEW”.
2. Press and hold the RESET button for two seconds and release to reset the oil life to 100%.

Note: To change oil life 100% value to another value, proceed to Step 3.

3. Once “OIL LIFE SET TO XXX%” is displayed, release and press the RESET button to change the oil life start value. Each release and press will reduce the value by 10%.

UNITS

Displays the current units English or Metric.

Press the RESET button to change from English to Metric.

AUTOLAMP (SEC)

This feature keeps your headlights on for up to three minutes after the ignition is switched off.

Press the RESET control to select the new autolamp delay values of 0, 10, 20, 30, 60, 90, 120 or 180 seconds.

AUTOLOCK

This feature automatically locks all vehicle doors when the vehicle is shifted into any gear, putting the vehicle in motion.

Press the RESET control to turn autolock on or off.

AUTOUNLOCK

This feature automatically unlocks all vehicle doors when the driver's door is opened within 10 minutes of the ignition being turned off.

Press RESET to turn it off or on.

RESET FOR ZONE SETTING

This feature changes the compass zone setting.

Most geographic areas (zones) have a magnetic north compass point that varies slightly from the northerly direction on maps. This variation is four degrees between adjacent zones and will become noticeable as the vehicle crosses multiple zones. A correct zone setting will eliminate this error.

Refer to *Compass zone/calibration adjustment*.

Instrument Cluster

ZONE <XX> RESET = CHANGE

The compass heading is displayed as one of N, NE, E, SE, S, SW, W and NW in the message center display.

Refer to *Compass zone/calibration adjustment*.

RESET FOR CALIBRATION

This feature calibrates the compass.

The compass reading may be affected when you drive near large buildings, bridges, power lines and powerful broadcast antenna. Magnetic or metallic objects placed in, on or near the vehicle may also affect compass accuracy. Usually, when something affects the compass readings, the compass will correct itself after a few days of operating your vehicle in normal conditions. If the compass still appears to be inaccurate, a manual calibration may be necessary.

Refer to *Compass zone/calibration adjustment*.

Compass zone/calibration adjustment

1. Determine your magnetic zone by referring to the zone map.
2. Turn ignition to the on position.
3. Start the engine.

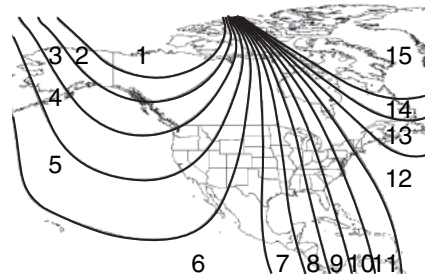

4. From the SETUP menu, press and release the RESET button until the message center display changes to show the current zone setting ZONE <XX> RESET = CHANGE.
5. Press and release the RESET button repeatedly until the correct zone setting for your geographic location is displayed on the message center. The range of zone values are from 1 to 15 and “wraps” back to 1.
6. To exit the zone setting mode, and to “lock in” your change:
 - press and release the SETUP button or,
 - press INFO button to exit or,
 - wait four seconds and the zone will be “locked in”.

Instrument Cluster

Perform compass calibration in an open area free from steel structures and high voltage lines. For optimum calibration, turn off all electrical accessories (heater/air conditioning, wipers, etc.) and make sure all vehicle doors are shut.

7. Press the RESET button until the display reads RESET FOR CALIBRATION to start the compass calibration function.

8. Slowly drive the vehicle in a circle (less than 3 mph [5 km/h]) until the CIRCLE SLOWLY TO CALIBRATE display changes to CALIBRATION COMPLETED. It will take up to five circles to complete calibration.

9. The compass is now calibrated.

Note: If the RESET button is pressed or three minutes has expired, the display will go back to the INFO menu and will show CAL instead of the compass heading until the compass is calibrated.

TBC MODE (if equipped)

Allows you to choose the trailer brake mode.

Press RESET to choose:

- ELECTRIC
- EOH (electric over hydraulic)

COURTESY WIPE

One extra wipe will occur a few seconds after washing the front window to clear any excess washer fluid remaining on the windshield.

Press RESET to turn this feature on or off.

CREATE MYKEY / MYKEY SETUP/ CLEAR MYKEY

For more information refer to *MyKey*[™] in the *Locks and Security* chapter.

RESET FOR REMOTE START (if equipped)

Press RESET to enable remote start on or off and choose the remote start duration time (5, 10, 15 minutes).

REAR PARK AID (if equipped)

This feature sounds a warning tone to warn the driver of obstacles near the rear bumper, and functions only when R (Reverse) gear is selected.

Press RESET stem to turn this feature on or off. You can also choose to turn this feature on/off when the vehicle is placed in reverse.

TRAILER SWAY (if equipped)

This feature uses the electronic stability control to mitigate trailer sway,

Press RESET to turn it off or on.

28

Instrument Cluster

LANGUAGE = ENGLISH / SPANISH / FRENCH

Allows you to choose which language the message center will display in. Selectable languages are English, Spanish, or French.

Waiting four seconds or pressing the RESET button cycles the message center through each of the language choices.

Press and hold the RESET button for two seconds to set the language choice.

System warnings

System warnings alert you to possible problems or malfunctions in your vehicle's operating systems.

In the event of a multiple warning situation, the message center will cycle the display to show all warnings by displaying each one for four seconds.

The message center will display the last selected feature if there are no more warning messages.

Types of messages and warnings:

- Some messages will appear briefly to inform you of something you may need to take action on or be informed of.
- Some messages will appear once and then again when the vehicle is restarted.
- Some messages will reappear after clearing or being reset if a problem or condition is still present and needs your attention.
- Some messages can be acknowledged and reset by pressing RESET. This allows you to use the full message center functionality by clearing the message.

PARK BRAKE ENGAGED — Displayed when the parking brake is applied (or not fully released).

CHECK BRAKE SYSTEM — Displayed when a fault has been detected by the ABS module.

CHECK CHARGING SYSTEM— Displayed when the electrical system is not maintaining proper voltage. If you are operating electrical accessories when the engine is idling at a low speed, turn off as many of the electrical loads as soon as possible. If the warning stays on or comes on when the engine is operating at normal speeds, contact your authorized dealer as soon as possible.

DRIVER DOOR AJAR — Displayed when the driver's door is not completely closed.

Instrument Cluster

PASSENGER DOOR AJAR — Displayed when the passenger's door is not completely closed.

REAR LEFT DOOR AJAR — Displayed when the rear left door is not completely closed.

REAR RIGHT DOOR AJAR — Displayed when the rear right door is not completely closed.

CHECK FUEL CAP — Displayed when the fuel cap may not be properly closed. Refer to *What you should know about automotive fuels* in the *Maintenance and Specifications* chapter.

PARK BRAKE ENGAGED — Displayed when the parking brake is set, the engine is running and the vehicle is driven more than 3 mph (5 km/h). If the warning stays on after the parking brake is released, contact your authorized dealer as soon as possible.

CHECK BRAKE SYSTEM — Displayed when a fault has been detected by the ABS module.

BRAKE FLUID LEVEL LOW — Indicates the brake fluid level is low and the brake system should be inspected immediately. Refer to *Brake fluid* in the *Maintenance and Specifications* chapter.

CHECK PARK AID (if equipped) — Displayed when the transmission is in R (Reverse) and the reverse sensing system (park aid) is disabled. Refer to *Rear park aid* in this section to enable.

TIRE PRESSURE SENSOR FAULT (if equipped) — Displayed when a tire pressure sensor is malfunctioning, or your spare tire is in use. For more information on how the system operates under these conditions, refer to *Understanding Your Tire Pressure Monitoring System (TPMS)* in the *Tires, Wheels and Loading* chapter. If the warning stays on or continues to come on, contact your authorized dealer as soon as possible.

LOW TIRE PRESSURE (if equipped) — Displayed when one or more tires on your vehicle have low tire pressure. Refer to *Inflating your tires* in the *Tires, Wheels and Loading* chapter.

TIRE PRESSURE MONITOR FAULT (if equipped) — Displayed when the tire pressure monitoring system (TPMS) is functioning. If the warning stays on or continues to come on, contact your authorized dealer as soon as possible.

TRAIN LEFT FRONT TIRE (if equipped) — Displayed when training the TPMS. Refer to *TPMS reset procedure* in the *Tires, Wheels and Loading* chapter for more information.

30

Instrument Cluster

TRAIN RIGHT FRONT TIRE (if equipped) — Displayed when training the TPMS. Refer to *TPMS reset procedure* in the *Tires, Wheels and Loading* chapter for more information.

TRAIN RIGHT REAR TIRE (if equipped) — Displayed when training the TPMS. Refer to *TPMS reset procedure* in the *Tires, Wheels and Loading* chapter for more information.

TRAIN LEFT REAR TIRE (if equipped) — Displayed when training the TPMS. Refer to *TPMS reset procedure* in the *Tires, Wheels and Loading* chapter for more information.

TIRES NOT TRAINED – REPEAT (if equipped) — Displayed when an error occurs while training the TPMS. Refer to *TPMS reset procedure* in the *Tires, Wheels and Loading* chapter for more information.

TRAINING COMPLETE (if equipped) — Displayed when training of the TPMS is complete. Refer to *TPMS reset procedure* in the *Tires, Wheels and Loading* chapter for more information.

TRACTION CONTROL OFF (if equipped) — Displayed when the traction control has been disabled by the driver. Refer to the *Driving* chapter for more information.

INTKEY COULD NOT PROGRAM — Displayed when an attempt is made to program a fifth integrated key to the remote keyless entry system. For more information on integrated key, refer to the *Locks and Security* chapter.

KEY COULD NOT PROGRAM — Displayed when an attempt is made to program a spare key using two existing MyKeys. Refer to *MyKey™* in the *Locks and Security* chapter for more information.

VEHICLE SPEED 80 MPH MAX — Displayed when a MyKey™ is in use and the Admin has enabled the MyKey speed limit and the vehicle speed is 80 mph (130 km/h). Refer to *MyKey™* in the *Locks and Security* chapter for more information.

SPEED LIMITED TO 80 MPH — Displayed when starting the vehicle and MyKey™ is in use and the MyKey speed limit is on. Refer to *MyKey™* in the *Locks and Security* chapter for more information.

CHECK SPEED DRIVE SAFELY — Displayed when a MyKey™ is in use and the optional setting is on and the vehicle exceeds a preselected speed. Refer to *MyKey™* in the *Locks and Security* chapter for more information.

Instrument Cluster

VEHICLE NEAR TOP SPEED — Displayed when a MyKey™ is in use and the MyKey speed limit is on and the vehicle speed is approaching 80 mph (130 km/h). Refer to *MyKey™* in the *Locks and Security* chapter for more information.

TOP SPEED MYKEY SETTING — Displayed when a MyKey™ is in use and the MyKey speed limit is on and the vehicle speed is 80 mph (130 km/h). Refer to *MyKey™* in the *Locks and Security* chapter for more information.

BUCKLE UP TO UNMUTE AUDIO — Displayed when a MyKey™ is in use and Belt-Minder® is activated. Refer to *MyKey™* in the *Locks and Security* chapter for more information.

ADVTRAC ON MYKEY SETTING (if equipped) — Displayed when a MyKey™ is in use when trying to disable the ESC system and the optional setting is on. Refer to *MyKey™* in the *Locks and Security* chapter for more information.

SERVICE ADVANCETRAC (if equipped) — Displayed when the AdvanceTrac® system has detected a condition that requires service. Contact your authorized dealer as soon as possible.

TO STOP ALARM START VEHICLE (if equipped) — Displayed when the perimeter alarm system is armed and the vehicle is entered using the key on the driver's side door. In order to prevent the perimeter alarm system from triggering, the ignition must be turned to start or on before the 12 second chime expires. See *Perimeter alarm system* in the *Locks and Security* chapter.

SECURITY SYSTEM FAULT — Displayed when the security system has detected a fault. See your authorized dealer for service.

WIRING FAULT ON TRAILER (if equipped) — Displayed and accompanied by a single chime if there are certain faults in the vehicle wiring and trailer wiring/brake system. Refer to *Trailer towing* in the *Tires, Wheels and Loading* chapter for more information.

TRAILER BRAKE MODULE FAULT (if equipped) — Displayed and accompanied by a single chime in response to faults sensed by the TBC. Refer to *Trailer towing* in the *Tires, Wheels and Loading* chapter for more information.

TRAILER CONNECTED (if equipped) — Displayed when a correct trailer connection (a trailer with electric trailer brakes) is sensed during a given ignition cycle. Refer to *Trailer towing* in the *Tires, Wheels and Loading* chapter for more information.

TRAILER BRAKE GAIN = XX.X (if equipped) — Displays the current gain setting for the trailer brake. Refer to *Trailer towing* in the *Tires, Wheels and Loading* chapter for more information.

Instrument Cluster

TBC GAIN = XX.X NO TRAILER (if equipped) — Displays the current gain setting for the trailer brake when a trailer is not connected. Refer to *Trailer towing* in the *Tires, Wheels and Loading* chapter for more information.

TRAILER DISCONNECTED (if equipped) — Displayed and accompanied by a single chime when a trailer connection becomes disconnected, either intentionally or unintentionally, and has been sensed during a given ignition cycle. Refer to *Trailer towing* in the *Tires, Wheels and Loading* chapter for more information.

TRAILER SWAY REDUCE SPEED (if equipped) — Displayed when the trailer sway control has detected trailer sway. For more information, refer to the *Driving* chapter for more information.

CHECK PARK AID (if equipped) — Displayed when the transmission is in R (Reverse) and the reverse sensing system (park aid) is disabled.

CHECK LOCKING DIFFERENTIAL (if equipped) — Displayed when an electronic locking differential (ELD) system fault is present. For more information, refer to *Electronic locking differential (ELD)* in the *Driving* chapter.

CHECK 4X4 (if equipped) — Displayed when a 4X4 system fault is present. For more information, refer to *Four-wheel drive (4WD) operation* in the *Driving* chapter.

4X4 SHIFT IN PROGRESS — Displayed when the 4X4 system is making a shift. For further information, refer to *Four-wheel drive (4WD) operation* in the *Driving* chapter.

FOR 4X4 LOW SLOW TO 3 MPH (if equipped) — Displayed when 4X4 LOW is selected while the vehicle is moving. For more information, refer to *Four-wheel drive (4WD) operation* in the *Driving* chapter.

FOR 4X4 LOW APPLY BRAKE (if equipped) — Displayed when trying to select 4X4 LOW. For more information, refer to *Four-wheel drive (4WD) operation* in the *Driving* chapter.

FOR 4X4 LOW SHIFT TO N (if equipped) — Displayed when 4X4 LOW is selected and the vehicle is stopped. For more information, refer to *Four-wheel drive (4WD) operation* in the *Driving* chapter.

TO EXIT 4X4 LOW SLOW TO 3 MPH (if equipped) — Displayed when 2WD is selected while the vehicle is operating in 4X4 LOW. For more information, refer to *Four-wheel drive (4WD) operation* in the *Driving* chapter.

TO EXIT 4X4 LOW SHIFT TO N (if equipped) — Displayed when 2WD is selected while the vehicle has been stopped in 4X4 LOW. For more information, refer to *Four-wheel drive (4WD) operation* in the *Driving* chapter.

Instrument Cluster

TO EXIT 4X4 LOW APPLY BRAKE (if equipped) — Displayed when 2WD is selected from 4X4 LOW mode. For more information, refer to *Four-wheel drive (4WD) operation* in the *Driving* chapter.

SHIFT DELAYED PULL FORWARD (if equipped) — May display when shifting to or from 4X4 LOW. For more information, refer to *Four-wheel drive (4WD) operation* in the *Driving* chapter.

HILL DESCENT CONTROL READY (if equipped) — Displayed when the hill descent control switch is turned on.

HILL DESCENT CONTROL FAULT (if equipped) — Displayed when a hill descent system fault is present.

HILL CNTRL OFF SYSTEM COOLING (if equipped) — Displayed when the hill descent system is cooling due to overuse.

HILL DESCENT CONTROL OFF (if equipped) — Displayed when the hill descent system is deactivated.

FOR HILL CNTRL 20 MPH OR LESS (if equipped) — Displayed when the vehicle speed requirement for hill control mode entry has not been met.

DRIVER RESUME CONTROL (if equipped) — Displayed when the hill control and off-road mode require the driver to resume control.

FOR HILL CNTRL SELECT GEAR (if equipped) — Displayed when the driver is requested to select a transmission gear to enable operation of the hill mode and off-road mode.

ENGINE WARMING PLEASE WAIT XX (Diesel engine only) — Displayed in extremely cold weather, typically below -15°F (-26°C), if the engine block heater is not utilized. The engine will not respond to accelerator pedal movement for 30 seconds; this is done so the engine oil can be properly circulated to avoid engine damage from lack of lubrication. A timer will begin a countdown from 30 seconds. Once the counter has reached 0 seconds, OK TO DRIVE will be displayed and the engine will respond to accelerator pedal movement. Refer to your diesel supplement for more information.

OK TO DRIVE (Diesel engine only) — Displayed when the time counter has reached 0 (zero) and the engine is sufficiently warm enough to drive in extremely cold weather (refer to the engine warming please wait message description mentioned previously). Refer to your diesel supplement for more information.



WATER IN FUEL DRAIN FILTER (Diesel engine only) — Displayed when the water separator has reached a predetermined capacity and needs to be drained. Refer to your diesel supplement for more information.

Instrument Cluster

ENGINE TURNS OFF IN XX (Diesel engine only) — Displayed when the vehicle is in the final 30 seconds of a countdown to where the engine will intentionally be turned off by the PCM. The diesel engine shutdown is a (regulatory) requirement which may be required of a particular diesel vehicle for sale in states requiring this feature. Refer to your diesel supplement for more information.

ENGINE TURNED OFF (Diesel engine only) — Displayed after the 30 second countdown. Refer to your diesel supplement for more information.

DRIVE TO CLEAN EXHAUST FILTER (Diesel engine only) — Displayed when the Diesel Particulate Filter (DPF) is full of particles (exhaust soot) and the vehicle is not being operated in a manner to allow normal cleaning. This message will stay on until the exhaust filter cleaning has begun, at which time the CLEANING EXHAUST FILTER message will be displayed. It is recommended the vehicle operator drive the vehicle above 30 mph (48 km/h) until the CLEANING EXHAUST FILTER message turns off. This message is NORMAL. Refer to your diesel supplement for more information.

Note: If this message is ignored, your vehicle will continue to fill the Diesel Particulate Filter (DPF) with particles (exhaust soot). If cleaning is not permitted, the  light will illuminate and engine power may be limited. If the vehicle is still not operated in a manner to allow cleaning, the service engine soon light  will illuminate and engine power will be further limited. Dealer service will then be required to restore your vehicle to full-power operation.

Note: Diesel Particulate Filter (DPF) regeneration will not initiate at idle or in Power Take Off (PTO) mode. When DRIVE TO CLEAN EXHAUST FILTER is displayed in the message center, PTO and/or Stationary Elevated Idle Control (SEIC) must be disengaged/inactive in order to properly clean the DPF. The vehicle must be driven until the CLEANING EXHAUST FILTER message turns off.

CLEANING EXHAUST FILTER (Diesel engine only) — Displayed when the vehicle has entered the cleaning mode. Various engine actions will raise the exhaust temperature in the Diesel Particulate Filter (DPF) system to burn off the particles (exhaust soot). After the particles are burned off, the exhaust temperature will fall back to normal levels. This message is NORMAL. Refer to your diesel supplement for more information.

Instrument Cluster



WARNING: When the CLEANING EXHAUST FILTER message appears in the message center, do not park near flammable materials, vapors or structures until filter cleaning is complete.

EXHAUST FILTER DRIVE COMPLETE (Diesel engine only) — Displayed when the Diesel Particulate Filter (DPF) has been adequately cleaned after the DRIVE TO CLEAN EXHAUST FILTER followed by CLEANING EXHAUST FILTER messages have been displayed. This message is NORMAL. Refer to your diesel supplement for more information.

STOP SAFELY NOW (Diesel engine only) — Displayed and a chime sounds when the vehicle exhaust system temperature exceeds intended operating range. If this warning occurs, engine power is reduced and the engine will shut down when the vehicle speed is below 3 mph (5 km/h).

Stop the vehicle as soon as safely possible and contact your authorized dealer. Depending on the severity of the over-temperature condition, the vehicle may not restart after cycling the ignition off. If the vehicle restarts, there may be limited power. If the exhaust over-temperature condition reoccurs, the message center will display STOP SAFELY NOW, the chime will sound, and engine power will be reduced again and shut down below 3 mph (5 km/h). Refer to your diesel supplement for more information.

REDUCED ENGINE POWER (Diesel engine only) — Displayed approximately two hours after the DRIVE TO CLEAN EXHAUST SYSTEM message has displayed and the vehicle operator has not driven the vehicle above 30 mph (48 km/h) for at least 20 minutes to clean the DPF. At this point the vehicle must be serviced by an authorized dealer. This message is normal. Refer to your diesel supplement for more information.

EXHAUST FLUID RANGE XXX MI (Diesel engine only) — Displays the distance you can travel before depleting the remaining diesel exhaust fluid. Refer to your diesel supplement for more information.

EXHAUST FLUID RANGE XXX KM (Diesel engine only) — Displays the distance you can travel before depleting the remaining diesel exhaust fluid. Refer to your diesel supplement for more information.

SPEED LIMITED YYMPH IN XX MI EXHAUST FLUID EMPTY (Diesel engine only) — Displayed when the diesel exhaust fluid is nearing empty. The vehicle's top speed will become limited in the displayed distance. The diesel exhaust fluid must be replenished to resume normal operation of the vehicle. Refer to your diesel supplement for more information.

Instrument Cluster

SPEED LIMITED YYKMH IN XXXKM EXHAUST FLUID EMPTY (Diesel engine only) — Displayed when the diesel exhaust fluid is nearing empty. The vehicle's top speed will become limited in the displayed distance. The diesel exhaust fluid must be replenished to resume normal operation of the vehicle. Refer to your diesel supplement for more information.

YY MPH MAX UPON RESTART EXHAUST FLUID EMPTY (Diesel engine only) — Displayed when the remaining diesel exhaust fluid level is depleted. Speed will be limited upon restart. The diesel exhaust fluid must be replenished to resume normal operation of the vehicle. Refer to your diesel supplement for more information.

YY KM/H MAX UPON RESTART EXHAUST FLUID EMPTY (Diesel engine only) — Displayed when the remaining diesel exhaust fluid level is depleted. Speed will be limited upon restart. The diesel exhaust fluid must be replenished to resume normal operation of the vehicle. Refer to your diesel supplement for more information.

SPEED LIMITED TO YY MPH EXHAUST FLUID EMPTY (Diesel engine only) — Displayed when the diesel exhaust fluid is empty. The diesel exhaust fluid must be replenished to resume normal operation of the vehicle. Refer to your diesel supplement for more information.

SPEED LIMITED TO YY KM/H EXHAUST FLUID EMPTY (Diesel engine only) — Displayed when the diesel exhaust fluid is empty. The diesel exhaust fluid must be replenished to resume normal operation of the vehicle. Refer to your diesel supplement for more information.

ENGINE IDLED UPON REFUEL EXHAUST FLUID EMPTY (Diesel engine only) — Displayed when the diesel exhaust fluid is empty. The vehicle will enter into an idle-only mode upon refueling. The diesel exhaust fluid must be replenished to resume normal operation of the vehicle. Refer to your diesel supplement for more information.

ENGINE IDLED SEE MANUAL EXHAUST FLUID EMPTY (Diesel engine only) — Displayed when the diesel exhaust fluid is empty. The vehicle will enter into an idle-only mode. The diesel exhaust fluid must be replenished to resume normal operation of the vehicle. Refer to your diesel supplement for more information.

ENGINE IDLED SEE MANUAL (Diesel engine only) — Displayed when a problem exists with the SCR system. The vehicle will enter into an idle-only mode. The diesel exhaust fluid must be replenished to resume normal operation of the vehicle. Refer to your diesel supplement for more information.

Instrument Cluster

SPEED LIMITED YYMPH IN XX MI CONTAMINATED EXHAUST FLUID (Diesel engine only) — Displayed when the diesel exhaust fluid becomes contaminated. Speed will be limited in the displayed distance. The diesel exhaust fluid must be replaced to resume normal operation of the vehicle. Refer to your diesel supplement for more information.

SPEED LIMITED YYKMH IN XXXKM CONTAMINATED EXHAUST FLUID (Diesel engine only) — Displayed when the diesel exhaust fluid becomes contaminated. Speed will be limited in the displayed distance. The diesel exhaust fluid must be replaced to resume normal operation of the vehicle. Refer to your diesel supplement for more information.

YY MPH MAX UPON RESTART CONTAMINATED EXHAUST FLUID (Diesel engine only) — Displayed when the diesel exhaust fluid is contaminated. Speed will be limited upon restart. The diesel exhaust fluid must be replaced to resume normal operation of the vehicle. Refer to your diesel supplement for more information.

YY KM/H MAX UPON RESTART CONTAMINATED EXHAUST FLUID (Diesel engine only) — Displayed when the diesel exhaust fluid is contaminated. Speed will be limited upon restart. The diesel exhaust fluid must be replaced to resume normal operation of the vehicle. Refer to your diesel supplement for more information.

SPEED LIMITED TO YY MPH CONTAMINATED EXHAUST FLUID (Diesel engine only) — Displayed when the diesel exhaust fluid is contaminated. The diesel exhaust fluid must be replaced to resume normal operation of the vehicle and prevent a limited speed range. Refer to your diesel supplement for more information.

SPEED LIMITED TO YY KM/H CONTAMINATED EXHAUST FLUID (Diesel engine only) — Displayed when the diesel exhaust fluid is contaminated. The diesel exhaust fluid must be replaced to resume normal operation of the vehicle and prevent a limited speed range. Refer to your diesel supplement for more information.

ENGINE IDLED UPON REFUEL CONTAMINATED EXHAUST FLUID (Diesel engine only) — Displayed when the diesel exhaust fluid is contaminated. The vehicle will enter into an idle-only mode upon refueling the vehicle. The diesel exhaust fluid must be replaced to resume normal operation of the vehicle. Refer to your diesel supplement for more information.

Instrument Cluster

ENGINE IDLED SEE MANUAL CONTAMINATED EXHAUST FLUID (Diesel engine only) — Displayed when the diesel exhaust fluid is contaminated. The vehicle will enter into an idle-only mode. The diesel exhaust fluid must be replaced to resume normal operation of the vehicle. Refer to your diesel supplement for more information.

ENGINE OIL DILUTED(diesel engine only) — Displays once the engine oil has become diluted and needs to be changed. Refer to your diesel supplement for more information.

ENGINE OIL CHANGE SOON — Displayed when the engine oil life remaining is 5% to 1%. Refer to the *scheduled maintenance information* for more information.

OIL CHANGE REQUIRED — Displayed when the oil life left reaches 0%. Refer to the *scheduled maintenance information* for more information.

LOW FUEL PRESSURE SEE MANUAL (Diesel engine only) — If this message appears during a cold start or during cold operation 32°F (0°C) up to 10 minutes after the initial cold start; monitor the message center and if it disappears and does not re-appear after the engine has fully warmed up, the low fuel pressure message is most likely caused by waxed or gelled fuel. To prevent this, use an anti-gel additive. Refer to your diesel supplement for more information. The customer warranty may be void from using additives that do not meet or exceed Ford specifications. If the low fuel pressure message persistently appears after re-fueling during the cold start and cold operation conditions defined previously and then disappear when the engine has fully warmed up, consider different fuel sources.

- **Low Fuel Operation:** If the message appears when the vehicle is warm and during low fuel tank level operation, i.e. the tank level is at or very near empty, refuel the vehicle and operate the vehicle. If the message reappears after fueling, see below. If the message does not come back, the low fuel pressure condition was due to low fuel levels in the fuel tank.
- **Normal Operation:** If the message appears during normal operation when the vehicle / engine is fully warm, and fuel level is not low, the fuel filters must be changed regardless of the maintenance schedule interval. If replacement of the fuel filter does not remedy the low fuel pressure message during normal operation as defined above, please take the vehicle to your authorized dealer.

Instrument Cluster

OPTIONAL MESSAGE CENTER (IF EQUIPPED)

Your vehicle's message center is capable of monitoring many vehicle systems and will alert you to potential vehicle problems and various conditions with a informational messages and/or warnings.

The message center is also used to program/configure the different features of your vehicle.

The message center display is located in the instrument cluster. Use the steering wheel mounted buttons to navigate through the message center.

Press the up/down buttons to move up/down through the message center choices.

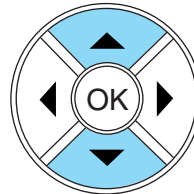

Press the left/right buttons to move left/right through the message center choices.

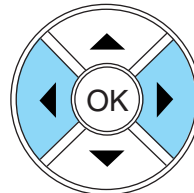

Press the OK button to select highlighted options and confirm choices/messages.

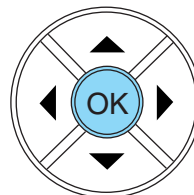

Instrument Cluster

Main menu

From the main menu screen you can choose the following:

- Gauge Mode
- Trip A/B
- Fuel Economy
- Truck Apps (if equipped)
- Settings
- Information

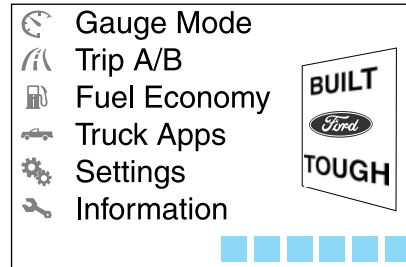

Scroll up/down to highlight one of the options, then press the right arrow key or OK to enter into that menu option.

Gauge Mode

Gauge Detail: In this mode, the following options are available in different graphical formats:

- Engine oil temperature (diesel only).
- Transmission temperature.
- Compass (see compass following for compass options).
- Blank screen.

Compass: The compass orientation can be changed between fixed north or rotating north. To change the modes, press OK when the compass display is shown. Use the right arrow to choose the mode. Press and hold OK to set the mode.

Trip A/B

In this mode, Trip A or B registers the following:

- Trip time — shows the elapsed trip time. This timer will stop when the vehicle is turned off and will restart when the vehicle is restarted.
- Trip distance — shows the accumulated trip distance.
- Fuel used — shows the amount of fuel used for a given trip.
- Average MPG (L/100km) — shows the average distance traveled per unit of fuel used for a given trip.
- Odometer — shows the vehicle's total accumulated distance. This value cannot be reset.

Instrument Cluster

Press the right arrow key to reach Trip B. Press the left arrow to go back to Trip A.

Press OK to pause the Trip A or B screen/press again to un-pause.

Press and hold OK to reset the currently displayed trip information.

Fuel Economy

In this mode, fuel economy information is displayed as follows:

- Instant MPG (L/100km) — shows instantaneous fuel usage.
- Miles (kilometers) to empty — shows the approximate distance the vehicle can travel before running out of fuel.
- Average MPG (L/100km) — shows the average fuel usage based on time. See Fuel Hist. following to change the time interval. Press and hold OK to reset this value.

If you calculate your average fuel economy by dividing miles traveled by gallons of fuel used (liters of fuel used by 100 kilometers traveled), your figure may be different than displayed for the following reasons:

- Your vehicle was not perfectly level during fill-up.
- Differences in the automatic shut-off points on the fuel pumps at service stations.
- Variations in top-off procedure from one fill-up to another.
- Rounding of the displayed values to the nearest 0.1 gallon (liter).

To determine your average highway fuel economy, do the following:

1. Drive the vehicle at least 5 miles (8 km) with the speed control system engaged to display a stabilized average.
2. Record the highway fuel economy for future reference.

It is important to press RESET in order to reset the function after setting the speed control to get accurate highway fuel economy readings.

For more information refer to *Essentials of good fuel economy* in the *Maintenance and Specifications* chapter.

Fuel Hist.: Press the right arrow key (when in the Fuel Econ. menu) to reach Fuel Hist. Fuel history shows fuel usage (AVG MPG or L/100km) as a bar graph based on time. The duration time can be changed as follows:

Duration— Press the right arrow key (when in the Fuel Hist. menu) to reach the following duration choices.

- 5 Minutes.

42

Instrument Cluster

- 10 Minutes.
- 30 Minutes.
- Last 5 Resets.

Use the up/down arrows keys to highlight one of the choices; press and hold OK to set your choice.

The graph is updated each minute with the fuel economy that was achieved during the prior 5, 10, 30 minutes or last 5 resets of driving.

Truck Apps (if equipped)

In this mode, off-road and trailer towing application options are available.

Off Road
Pitch and bank angle (in degrees) (if equipped). Displays the pitch angle (front to rear) and bank angle (side to side) of the road surface.
Steering angle (in degrees). Displays the steering angle of the front wheels.
Differential lock/unlock. Displays the state (locked or unlocked) of the electronic locking differential.
Energy flow. Displays the operating mode of the transfer case: 4X2, 4X4 Low or 4X4 High.

When “Press OK for info” is displayed, pressing OK will give you information on the following options (**Note:** Information is only available when traveling less than 3 mph [5 km/h]):

- ELD (electronic locking differential)
- Hill Descent Control
- 4X4 System
- Traction Control

Trailer: Press the right arrow key (when in the Off Road menu) to reach the Trailer menu. The following information is displayed

- Active trailer name or default trailer.
- Accumulated trailer distance.
- Trailer gain and output.
- Trailer disconnected

Instrument Cluster

When “Press OK for options” is displayed, pressing OK will open the trailer options menus:

Trailer	
Change Active Trailer	<p>When this is highlighted, press the right arrow key to change the currently selected trailer. Use the up and down arrows to select a trailer and press the OK button to choose the highlighted trailer.</p> <p>Adding a new trailer– Use the up/down arrows to highlight “New Trailer” from the Change Active Trailer menu and press the right arrow key to enter the New Trailer input screen. Use the up/down arrow keys to choose alpha, numeric and symbol characters and then press the right arrow to move the character space over. Continue adding characters as needed. Press the left arrow to go back and change a previously selected character. When finished with the new trailer name, press OK to accept the new trailer name.</p>
Connection Checklist (if equipped)	<p>Press the right arrow button when this is highlighted to show the trailer connection types: Conventional, Fifth Wheel and Gooseneck. Use the up/down arrows to highlight one of these choices and press OK to display the connection checklist. Follow the on-screen instructions to go through the connections list.</p>
Delete Trailer	<p>Press the right arrow button when this is highlighted to show currently stored trailers. Use the up/down arrows to highlight the trailer you want to delete and press OK to delete. Follow the on-screen prompts to exit or confirm delete.</p>
Information Screen	<p>Press the right arrow button when this is highlighted to display information on the following vehicle features: Tow Haul mode, Trailer Brake Controller.</p>

Instrument Cluster

Trailer	
Rename Trailer	Press the right arrow button when this is highlighted to display saved or default trailers. Use the up/down buttons to highlight a trailer and press OK to select it. Use the up/down arrow buttons to change the characters as needed. When done, press OK to accept the change.
Reset Trailer Mileage/ Kilometers (if equipped)	Press the right arrow button when this is highlighted to display accumulated distance on a given trailer within the list of trailer(s). Use the up/down buttons to select a trailer, then press and hold OK to reset the trailer mileage (kilometers).

Settings

In this mode, you can configure different driver setting choices. Press the right arrow key (when in the Settings menu) to reach the Driver Assist menu:

Driver Assist	
Rear Park Aid	On/Off
Rear View Camera (Camera Delay)	On/Off
Trailer Brake Mode	Electric or Electric Over Hydraulic
Trailer Sway Control	On/Off
Vehicle	
Autolamp Delay	Off or XXX seconds
Compass	Zone Setting (1–15) See the diagram below to determine your magnetic zone.

Instrument Cluster

Determine which magnetic zone you are in for your geographic location by referring to the zone map.

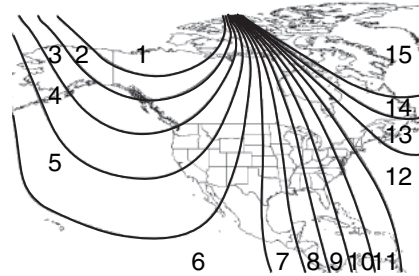

Vehicle (cont'd)		
Compass (cont'd)	Calibration (When choosing Calibration, follow the on-screen directions to calibrate the compass)	
DTE Calculation (distance to empty)	Normal	History used
	Towing	
Locks	Autolock,	On/Off
	Autounlock	On/Off
	Unlocking	One Stage or Two Stage
Maintenance	Coolant (diesel only)	Hold OK if Coolant Changed / Additive Checked
	Fuel Filter (diesel only)	Hold OK if Fuel Filter Changed
Oil Life Reset (gas engine only)	Set to New or XXX% (Press and hold OK to set).	
Menu Control	Standard: With standard set, pressing the down arrow from any menu level will escape to the main menu. Memory On: With memory on set, pressing the down arrow will navigate to the previous lower level menu.	
Remote Start	System (remote start on/off)	5, 10 or 15 minutes (Duration)
		Enable/Disable

Instrument Cluster

MyKey	
Create MyKey	Press and hold OK to create MyKey
AdvanceTrac	Always on or Selectable
MAX MPH (km/h)	80 MPH (120 km/h) or Off
Speed Warning	45, 55 or 65 MPH (75, 90 or 105 km/h)
Volume Limiter	On/Off
Clear MyKeys	Hold OK to Clear MyKeys
Language	
English, Español, Français	
Units	
Distance	Miles and GAL or Kilometers and L
Temperature	Fahrenheit (°F) or Celsius (°C)
System Reset	
Hold OK to Reset System to Factory Defaults	

Information

In this mode, you can view different vehicle system information and perform a system check.

When “Press OK for info” is displayed, pressing OK will give you information on the currently selected/displayed options. Information is only available when traveling less than 3 mph (5 km/h).

MyKey	
Admin Keys (Number of admin keys)	
MyKeys (Number of MyKeys programmed)	
MyKey Miles (km) (Distance traveled using a programmed MyKey)	
System Check	
Oil Life	
Engine Hours	
Engine Idle Hours	
Doors	
Exhaust Fluid (Level – diesel only)	

Instrument Cluster

System Check	
Brakes	
Tire Pressure	
Trailer Brake Ctrl.	Gain and Output (when trailer is connected) No trailer (when no trailer is connected)
Trailer Sway	
Park Aid	Check Rear Park Aid
Fuel Level (distance to empty)	

Some items will only display during a system check if a problem has been detected. If an issue exists on one of the monitored systems, the message center will display the number of warnings that need immediate attention in red and the number of informational warnings will be listed in amber. Use the up/down arrow buttons to scroll through the list; press the right arrow button to display specific information on the highlighted warning.

Exterior temperature/Compass/Transmission indicator displays

The exterior temperature and compass heading will display in the upper right corner of the message center; the transmission gear indicator will display on the right side of the message center. They will not be shown in all screen modes, for example, when programming certain vehicle features or in certain information menus.

System warnings and status messages

System warnings alert you to possible problems or malfunctions in your vehicle's operating systems.

In the event of a multiple warning situation, the message center will cycle the display to show all warnings by displaying each one for four seconds.

The message center will display the last selected feature if there are no more warning messages.

Types of messages and warnings:

- Some messages will appear briefly to inform you of something you may need to take action on or be informed of.
- Some messages will appear once and then again when the vehicle is restarted.
- Some messages will reappear after clearing or being reset if a problem or condition is still present and needs your attention.

Instrument Cluster

- Some messages can be acknowledged and reset by pressing RESET. This allows you to use the full message center functionality by clearing the message.

DOOR AJAR — Displayed when the door is not completely closed.

DRIVER DOOR AJAR — Displayed when the driver door is not completely closed.

LEFT REAR DOOR AJAR — Displayed when the rear left door is not completely closed.

PASSENGER DOOR AJAR — Displayed when the passenger door is not completely closed.

RIGHT REAR DOOR AJAR — Displayed when the rear right door is not completely closed.

CHECK FUEL CAP — Displayed when the fuel cap may not be properly closed. Refer to *What you should know about automotive fuels* in the *Maintenance and Specifications* chapter.

XXX KM TO E FUEL LEVEL LOW — Displayed as an early reminder of a low fuel condition.

XXX MILES TO E FUEL LEVEL LOW — Displayed as an early reminder of a low fuel condition.

BRAKE FLUID LEVEL LOW — Indicates the brake fluid level is low and the brake system should be inspected immediately. Refer to *Brake fluid* in the *Maintenance and Specifications* chapter.

CHECK BRAKE SYSTEM — Displayed when the brake system needs servicing. If the warning stays on or continues to come on, contact your authorized dealer as soon as possible.

PARK BRAKE ENGAGED — Displayed when the parking brake is set, the engine is running and the vehicle is driven more than 3 mph (5 km/h). If the warning stays on after the parking brake is released, contact your authorized dealer as soon as possible.

ADVANCETRAC OFF (if equipped) — Displayed when the AdvanceTrac® system has been disabled by the driver.

SERVICE ADVANCETRAC (if equipped) — Displayed when the AdvanceTrac® system has detected a condition that requires service. Contact your authorized dealer as soon as possible.

CHECK COOLANT ADDITIVE (diesel engine only) — Displayed when the coolant additive needs to be checked. Refer to your diesel supplement for more information.

Instrument Cluster



POWER REDUCED TO LOWER ENGINE TEMP — Displayed when the engine temperature gauge needle moves to H. You may notice reduced engine power. Refer to *Engine coolant* in the *Maintenance and Specifications* chapter for more information.

CLEANING EXHAUST FILTER (diesel engine only) — Displayed when the vehicle has entered the cleaning mode. Various engine actions will raise the exhaust temperature in the Diesel Particulate Filter (DPF) system to burn off the particles (exhaust soot). After the particles are burned off, the exhaust temperature will fall back to normal levels. This message is NORMAL. Refer to your diesel supplement for more information.



WARNING: When the CLEANING EXHAUST FILTER message appears in the message center, do not park near flammable materials, vapors or structures until filter cleaning is complete.

DRIVE TO CLEAN EXHAUST SYSTEM (diesel engine only) — Displayed when the Diesel Particulate Filter (DPF) is full of particles (exhaust soot) and the vehicle is not being operated in a manner to allow normal cleaning. This message will stay on until the exhaust filter cleaning has begun, at which time the CLEANING EXHAUST FILTER message will be displayed. It is recommended the vehicle operator drive the vehicle above 30 mph (48 km/h) until the CLEANING EXHAUST FILTER message turns off. This message is NORMAL. Refer to your diesel supplement for more information.

Note: If this message is ignored, your vehicle will continue to fill the Diesel Particulate Filter (DPF) with particles (exhaust soot). If cleaning is not permitted, the  light will illuminate and engine power may be limited. If the vehicle is still not operated in a manner to allow cleaning, the service engine soon light  will illuminate and engine power will be further limited. Dealer service will then be required to restore your vehicle to full-power operation.

STOP SAFELY NOW (Diesel engine only) — Displayed and a chime sounds when the vehicle exhaust system temperature exceeds intended operating range. If this warning occurs, engine power is reduced and the engine will shut down when the vehicle speed is below 3 mph (5 km/h).

Stop the vehicle as soon as safely possible and contact your authorized dealer. Depending on the severity of the over-temperature condition, the vehicle may not restart after cycling the ignition off. If the vehicle restarts, there may be limited power. If the exhaust over-temperature condition reoccurs, the message center will display

50

Instrument Cluster

STOP SAFELY NOW, the chime will sound, and engine power will be reduced again and shut down below 3 mph (5 km/h). Refer to your diesel supplement for more information.

ENGINE IDLED UPON REFUEL CONTAMINATED EXHAUST FLUID (diesel engine only) — Displayed when the diesel exhaust fluid is contaminated. The vehicle will enter into an idle-only mode. The diesel exhaust fluid must be replaced to resume normal operation of the vehicle. Refer to your diesel supplement for more information.

ENGINE IDLED UPON REFUEL EXHAUST FLUID EMPTY (diesel engine only) — Displayed when the diesel exhaust fluid is empty. The vehicle will enter into an idle-only mode. The diesel exhaust fluid must be replenished to resume normal operation of the vehicle. Refer to your diesel supplement for more information.

ENGINE OIL DILUTED (diesel engine only) — Displays once the engine oil has become diluted and needs to be changed. Refer to your diesel supplement for more information.

ENGINE OIL CHANGE SOON — Displayed when the engine oil life remaining is 5% to 1%.

OIL CHANGE REQUIRED — Displayed when the oil life left reaches 0%.

ENGINE TURNS OFF IN 1 SECOND (diesel engine only) — Displayed when the vehicle is in the final second of a countdown to where the engine will intentionally be turned off by the PCM. The diesel engine shutdown is a (regulatory) requirement which may be required of a particular diesel vehicle for sale in states requiring this feature. Refer to your diesel supplement for more information.

ENGINE TURNS OFF IN XX SECONDS (diesel engine only) — Displayed when the vehicle is in the final 30 seconds of a countdown to where the engine will intentionally be turned off by the PCM. The diesel engine shutdown is a (regulatory) requirement which may be required of a particular diesel vehicle for sale in states requiring this feature. Refer to your diesel supplement for more information.

ENGINE TURNED OFF (diesel engine only) — Displayed after the 30 second countdown. Refer to your diesel supplement for more information.

ENGINE WARMING PLEASE WAIT (diesel engine only) — Displayed in extremely cold weather, typically below -15°F (-26°C), if the engine block heater is not utilized. The engine will not respond to accelerator pedal movement for 30 seconds; this is done so the engine oil

Instrument Cluster

can be properly circulated to avoid engine damage from lack of lubrication. A timer will begin a countdown from 30 seconds. Once the counter has reached 0 seconds, OK TO DRIVE will be displayed and the engine will respond to accelerator pedal movement. Refer to your diesel supplement for more information.

EXHAUST FILTER DRIVE COMPLETE (diesel engine only) — Displayed when the Diesel Particulate Filter (DPF) has been adequately cleaned after the DRIVE TO CLEAN EXHAUST FILTER followed by CLEANING EXHAUST FILTER messages have been displayed. This message is NORMAL. Refer to your diesel supplement for more information.

EXHAUST FLUID LEVEL OK (diesel engine only) — Displayed when the remaining diesel exhaust fluid level is above 1/2 full. Refer to your diesel supplement for more information.

EXHAUST FLUID UNDER 1/2 FULL (diesel engine only) — Displayed when the remaining diesel exhaust fluid level is under 1/2 full. Refer to your diesel supplement for more information.

EXHAUST FLUID RANGE XXX MI (diesel engine only) — Displays the distance you can travel before depleting the remaining diesel exhaust fluid. Refer to your diesel supplement for more information.

EXHAUST FLUID RANGE XXX KM (diesel engine only) — Displays the distance you can travel before depleting the remaining diesel exhaust fluid. Refer to your diesel supplement for more information.

FUEL FILTER CHANGE REQUIRED (diesel engine only) — Displayed when a fuel filter change is required. Refer to the *scheduled maintenance information* for more information.

IN XX KM, SPEED LIMITED TO YY KM/H CONTAMINATED EXHAUST FLUID (diesel engine only) — Displayed when the diesel exhaust fluid becomes contaminated. Speed will be limited when reaching the displayed distance. The diesel exhaust fluid must be replaced to resume normal operation of the vehicle. Refer to your diesel supplement for more information.

IN XX KM, SPEED LIMITED TO YY KM/H EXHAUST FLUID EMPTY (diesel engine only) — Displayed when the diesel exhaust fluid is nearing empty. The vehicle's top speed will become limited in the displayed distance. The diesel exhaust fluid must be replenished to resume normal operation of the vehicle. Refer to your diesel supplement for more information.

Instrument Cluster

IN XX MILES, SPEED LIMITED TO YY MPH CONTAMINATED EXHAUST FLUID (diesel engine only) — Displayed when the diesel exhaust fluid becomes contaminated. Speed will be limited when reaching the displayed distance. The diesel exhaust fluid must be replaced to resume normal operation of the vehicle. Refer to your diesel supplement for more information.

IN XX MILES, SPEED LIMITED TO YY MPH EXHAUST FLUID EMPTY (diesel engine only) — Displayed when the diesel exhaust fluid is nearing empty. The vehicle's top speed will become limited in the displayed distance. The diesel exhaust fluid must be replenished to resume normal operation of the vehicle. Refer to your diesel supplement for more information.

SPEED LIMITED TO XX KM/H CONTAMINATED EXHAUST FLUID (diesel engine only) — Displayed when the diesel exhaust fluid is contaminated. The diesel exhaust fluid must be replaced to resume normal operation of the vehicle and prevent a limited speed range. Refer to your diesel supplement for more information.

SPEED LIMITED TO XX KM/H EXHAUST FLUID EMPTY (diesel engine only) — Displayed when the diesel exhaust fluid is empty. The diesel exhaust fluid must be replenished to resume normal operation of the vehicle. Refer to your diesel supplement for more information.

SPEED LIMITED TO XX KM/H UPON RESTART CONTAMINATED EXHAUST FLUID (diesel engine only) — Displayed when the diesel exhaust fluid is contaminated. Speed will be limited upon restart. The diesel exhaust fluid must be replaced to resume normal operation of the vehicle. Refer to your diesel supplement for more information.

SPEED LIMITED TO XX KM/H UPON RESTART EXHAUST FLUID EMPTY (diesel engine only) — Displayed when the remaining diesel exhaust fluid level is depleted. Speed will be limited upon restart. The diesel exhaust fluid must be replenished to resume normal operation of the vehicle. Refer to your diesel supplement for more information.

SPEED LIMITED TO XX MPH CONTAMINATED EXHAUST FLUID (diesel engine only) — Displayed when the diesel exhaust fluid is contaminated. The diesel exhaust fluid must be replaced to resume normal operation of the vehicle and prevent a limited speed range. Refer to your diesel supplement for more information.

SPEED LIMITED TO XX MPH EXHAUST FLUID EMPTY (diesel engine only) — Displayed when the diesel exhaust fluid is empty. The diesel exhaust fluid must be replenished to resume normal operation of the vehicle. Refer to your diesel supplement for more information.

Instrument Cluster

SPEED LIMITED TO XX MPH UPON RESTART CONTAMINATED EXHAUST FLUID (diesel engine only) — Displayed when the diesel exhaust fluid is contaminated. Speed will be limited upon restart. The diesel exhaust fluid must be replaced to resume normal operation of the vehicle. Refer to your diesel supplement for more information.

SPEED LIMITED TO XX MPH UPON RESTART EXHAUST FLUID EMPTY (diesel engine only) — Displayed when the remaining diesel exhaust fluid level is depleted. Speed will be limited upon restart. The diesel exhaust fluid must be replenished to resume normal operation of the vehicle. Refer to your diesel supplement for more information.

LOW FUEL PRESSURE (diesel engine only) — If this message appears during a cold start or during cold operation 32°F (0°C) up to 10 minutes after the initial cold start; monitor the message center and if it disappears and does not re-appear after the engine has fully warmed up, the low fuel pressure message is most likely caused by waxed or gelled fuel. To prevent this, use an anti-gel additive. Refer to your diesel supplement for more information. The customer warranty may be void from using additives that do not meet or exceed Ford specifications. If the low fuel pressure message persistently appears after re-fueling during the cold start and cold operation conditions defined previously and then disappear when the engine has fully warmed up, consider different fuel sources.

- Low Fuel Operation: If the message appears when the vehicle is warm and during low fuel tank level operation, i.e. the tank level is at or very near empty, refuel the vehicle and operate the vehicle. If the message reappears after fueling, see below. If the message does not come back, the low fuel pressure condition was due to low fuel levels in the fuel tank.
- Normal Operation: If the message appears during normal operation when the vehicle / engine is fully warm, and fuel level is not low, the fuel filters must be changed regardless of the maintenance schedule interval. If replacement of the fuel filter does not remedy the low fuel pressure message during normal operation as defined above, please take the vehicle to your authorized dealer.

REDUCED ENGINE POWER (diesel engine only) — Displayed approximately two hours after the DRIVE TO CLEAN EXHAUST SYSTEM message has displayed and the vehicle operator has not driven the vehicle above 30 mph (48 km/h) for at least 20 minutes to clean the DPF. At this point the vehicle must be serviced by an authorized dealer. This message is normal. Refer to your diesel supplement for more information.

54

Instrument Cluster

WATER IN FUEL DRAIN FILTER SEE MANUAL (if equipped) — Displayed when the water separator has reached a predetermined capacity and needs to be drained. Refer to your diesel supplement for more information.

LOW TIRE PRESSURE — Displayed when one or more tires on your vehicle have low tire pressure. Refer to *Inflating Your Tires* in the *Tires, Wheels and Loading* chapter.

TIRE PRESSURE MONITOR FAULT — Displayed when the Tire Pressure Monitoring System is malfunctioning. If the warning stays on or continues to come on, have the system inspected by your authorized dealer.

TIRE PRESSURE SENSOR FAULT — Displayed when a tire pressure sensor is malfunctioning, or your spare tire is in use. For more information on how the system operates under these conditions, refer to *Understanding Your Tire Pressure Monitoring System (TPMS)* in the *Tires, Wheels and Loading* chapter. If the warning stays on or continues to come on, contact your authorized dealer as soon as possible.

TIRES NOT TRAINED - REPEAT — Displayed when an error occurs while training the TPMS. Refer to *TPMS reset procedure* in the *Tires, Wheels and Loading* chapter for more information.

TRAIN INNER LEFT REAR TIRE — Displayed when training the TPMS. Refer to *TPMS reset procedure* in the *Tires, Wheels and Loading* chapter for more information.

TRAIN INNER RIGHT REAR TIRE — Displayed when training the TPMS. Refer to *TPMS reset procedure* in the *Tires, Wheels and Loading* chapter for more information.

TRAIN LEFT FRONT TIRE — Displayed when training the TPMS system. Refer to *TPMS reset procedure* in the *Tires, Wheels and Loading* chapter for more information.

TRAIN LEFT REAR TIRE — Displayed when training the TPMS system. Refer to *TPMS reset procedure* in the *Tires, Wheels and Loading* chapter for more information.

TRAIN RIGHT FRONT TIRE — Displayed when training the TPMS system. Refer to *TPMS reset procedure* in the *Tires, Wheels and Loading* chapter for more information.

TRAIN RIGHT REAR TIRE — Displayed when training the TPMS system. Refer to *TPMS reset procedure* in the *Tires, Wheels and Loading* chapter for more information.

Instrument Cluster

TRAIN SPARE TIRE (if equipped) — Displayed when training the TPMS. Refer to *TPMS reset procedure* in the *Tires, Wheels and Loading* chapter for more information.

TRAINING COMPLETE — Displayed when training of the TPMS system is complete. Refer to *TPMS reset procedure* in the *Tires, Wheels and Loading* chapter for more information.

POWER STEERING ASSIST FAULT — The power steering system has disabled power steering assist due to a system error; service is required.

SERVICE POWER STEERING — The power steering system has detected a condition that requires service.

SERVICE POWER STEERING NOW — The power steering system has detected a condition that requires service immediately.

BUCKLE UP TO UNMUTE AUDIO — Displayed when a MyKey™ is in use and Belt-Minder® is activated. Refer to *MyKey™* in the *Locks and Security* chapter for more information.

TRACTION CONTROL OFF (if equipped) — Displayed when the traction control has been disabled by the driver. Refer to the *Driving* chapter for more information.

CHECK 4X4 (if equipped) — Displayed when a 4X4 system fault is present. For more information, refer to *Four-wheel drive (4WD) operation* in the *Driving* chapter.

4X4 SHIFT IN PROGRESS (if equipped) — Displayed when the 4X4 system is making a shift. For further information, refer to *Four-wheel drive (4WD) operation* in the *Driving* chapter.

FOR 4X4 LOW APPLY BRAKE (if equipped) — Displayed when trying to select 4X4 LOW. For more information, refer to *Four-wheel drive (4WD) operation* in the *Driving* chapter.

FOR 4X4 LOW SHIFT TO N (if equipped) — Displayed when 4X4 LOW is selected and the vehicle is stopped. For more information, refer to *Four-wheel drive (4WD) operation* in the *Driving* chapter.

FOR 4X4 LOW SLOW TO 3 MPH (if equipped) — Displayed when 4X4 LOW is selected while the vehicle is moving. For more information, refer to *Four-wheel drive (4WD) operation* in the *Driving* chapter.

TO EXIT 4X4 LOW APPLY BRAKE (if equipped) — Displayed when 2WD is selected from 4X4 LOW mode. For more information, refer to *Four-wheel drive (4WD) operation* in the *Driving* chapter.

Instrument Cluster

TO EXIT 4X4 LOW SHIFT TO N (if equipped) — Displayed when 2WD is selected while the vehicle has been stopped in 4X4 LOW. For more information, refer to *Four-wheel drive (4WD) operation* in the *Driving* chapter.

TO EXIT 4X4 LOW SLOW TO 3 MPH (if equipped) — Displayed when 2WD is selected while the vehicle is operating in 4X4 LOW. For more information, refer to *Four-wheel drive (4WD) operation* in the *Driving* chapter.

FOR HILL DESCENT REDUCE SPEED (if equipped) — Displayed when the vehicle speed requirement for off-road mode entry has not been met.

FOR HILL DESCENT SELECT GEAR (if equipped) — Displayed when the driver is able to select a transmission gear for hill descent mode.

HILL DESCENT - DRIVER RESUME CONTROL (if equipped) — Displayed when hill descent control mode is deactivated and the driver must resume control.

HILL DESCENT CONTROL FAULT (if equipped) — Displayed when a hill descent system fault is present.

HILL DESCENT CONTROL OFF (if equipped) — Displayed when hill descent control mode becomes inactive.

HILL DESCENT CONTROL OFF SYSTEM COOLING (if equipped) — Displayed when the hill descent system is cooling due to overuse.

HILL DESCENT CONTROL READY (if equipped) — Displayed when the hill descent control switch is turned on.

REDUCE ACCELERATOR TO PREVENT WHEEL SLIP (if equipped) — Displayed when the vehicle senses that torque to the drive wheels has overcome the available traction.

SHIFT DELAYED PULL FORWARD (if equipped) — May display when shifting to or from 4X4 LOW. For more information, refer to *Four-wheel drive (4WD) operation* in the *Driving* chapter.

SLOW VEHICLE TO XX KM/H FOR ELD (if equipped) — Displayed when the vehicle speed requirement for the electronic locking differential mode has not been met.

SLOW VEHICLE TO XX MPH FOR ELD (if equipped) — Displayed when the vehicle speed requirement for the electronic locking differential mode has not been met.

Instrument Cluster

CHECK LOCKING DIFFERENTIAL (if equipped) — Displayed when an electronic locking differential (ELD) system fault is present. For more information, refer to *Electronic locking differential (ELD)* in the *Driving* chapter.

CHECK SPEED DRIVE SAFELY — Displayed when a MyKey™ is in use and the optional setting is on and the vehicle exceeds a preselected speed. Refer to *MyKey™* in the *Locks and Security* chapter for more information.

COULD NOT PROGRAM INTEGRATED KEY — Displayed when an attempt is made to program a fifth integrated key to the remote keyless entry system. For more information on integrated key, refer to the *Locks and Security* chapter.

ESC ALWAYS ON - MYKEY SETTING — Displayed when a MyKey™ is in use and the ESC cannot be deactivated. Refer to *MyKey™* in the *Locks and Security* chapter for more information.

MYKEY ACTIVE DRIVE SAFELY — Displayed when a MyKey™ is in use. Refer to *MyKey™* in the *Locks and Security* chapter for more information.

MYKEY COULD NOT PROGRAM — Displayed when an attempt is made to program a spare key using two existing MyKeys. Refer to *MyKey™* in the *Locks and Security* chapter for more information.

SECURITY SYSTEM FAULT (if equipped) — Displayed when the security system has detected a fault. See your authorized dealer for service.

SPEED LIMITED TO 130 KM/H — Displayed when starting the vehicle and MyKey™ is in use and the MyKey speed limit is on. Refer to *MyKey™* in the *Locks and Security* chapter for more information.

SPEED LIMITED TO 80 MPH — Displayed when starting the vehicle and MyKey™ is in use and the MyKey speed limit is on. Refer to *MyKey™* in the *Locks and Security* chapter for more information.

VEHICLE AT TOP SPEED - MYKEY SETTING — Displayed when a MyKey™ is in use and the MyKey speed limit is on and the vehicle speed is 80 mph (130 km/h). Refer to *MyKey™* in the *Locks and Security* chapter for more information.

VEHICLE NEAR TOP SPEED — Displayed when a MyKey™ is in use and the MyKey speed limit is on and the vehicle speed is approaching 80 mph (130 km/h). Refer to *MyKey™* in the *Locks and Security* chapter for more information.

CHECK REAR PARK AID (if equipped) — Displayed when the transmission is in R (Reverse) and the park aid is disabled.

Instrument Cluster

REAR PARK AID OFF (if equipped) — Displayed when the rear park aid is disabled by the driver.

REAR PARK AID ON (if equipped) — Displayed when the rear park aid is enabled.

TO STOP ALARM, START VEHICLE (if equipped) — Displayed when the perimeter alarm system is armed and the vehicle is entered using the key on the driver's side door. In order to prevent the perimeter alarm system from triggering, the ignition must be turned to start or on before the 12 second chime expires. See *Perimeter alarm system* in the *Locks and security* chapter.

TRAILER BRAKE GAIN: XX.X [OUTPUT] (if equipped) — Displays the current gain setting for the trailer brake. Refer to *Trailer towing* in the *Tires, Wheels and Loading* chapter for more information.

TRAILER BRAKE GAIN: XX.X NO TRAILER (if equipped) — Displays the current gain setting for the trailer brake when a trailer is not connected. Refer to *Trailer towing* in the *Tires, Wheels and Loading* chapter for more information.

TRAILER BRAKE MODULE FAULT (if equipped) — Displayed and accompanied by a single chime, in response to faults sensed by the TBC. Refer to *Trailer towing* in the *Tires, Wheels and Loading* chapter for more information.

TRAILER CONNECTED (if equipped) — Displayed when a correct trailer connection (a trailer with electric trailer brakes) is sensed during a given ignition cycle. Refer to *Trailer towing* in the *Tires, Wheels and Loading* chapter for more information.

TRAILER DISCONNECTED (if equipped) — Displayed when a trailer connection becomes disconnected, either intentionally or unintentionally, and has been sensed during a given ignition cycle. Refer to *Trailer towing* in the *Tires, Wheels and Loading* chapter for more information.

TRAILER SWAY REDUCE SPEED (if equipped) — Displayed when the trailer sway control has detected trailer sway. For more information, refer to the *Driving* chapter for more information.

WIRING FAULT ON TRAILER (if equipped) — Displayed if there are certain faults in the vehicle wiring and trailer wiring/brake system. Refer to *Trailer towing* in the *Tires, Wheels and Loading* chapter for more information.

Entertainment Systems

AUDIO SYSTEMS

AM/FM stereo system (if equipped)

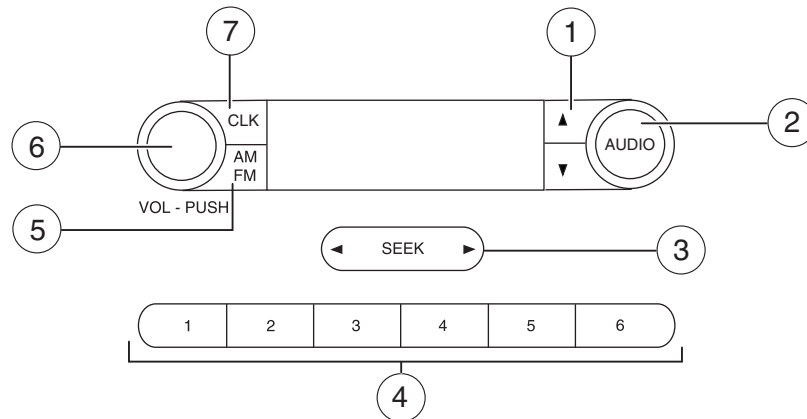

WARNING: Driving while distracted can result in loss of vehicle control, accident and injury. Ford strongly recommends that drivers use extreme caution when using any device or feature that may take their focus off the road. Your primary responsibility is the safe operation of the vehicle. We recommend against the use of any handheld device while driving and that you comply with all applicable laws.

The AM/FM stereo system does not contain rear speakers; only front driver side and passenger side speakers.

Accessory delay: Your vehicle is equipped with accessory delay. With this feature, the window switches and radio may be used for up to 10 minutes after the ignition is turned off or until either front door is opened.

1. **▲ / ▼ (Tuner):** Press to manually go up or down the radio frequency. Press and hold for a fast advance through radio frequencies. Also use in AUDIO mode to gain access to various settings.



60

Entertainment Systems

2. **AUDIO:** Press AUDIO repeatedly to gain access to the following settings:



TREB (Treble): Press AUDIO to reach the treble setting. Use ▲ / ▼ / ◀ SEEK ▶ .

BASS (Bass): Press AUDIO to reach the bass setting. Use ▲ / ▼ / ◀ SEEK ▶ .

BAL (Balance): Press AUDIO to reach the balance setting. Use ▲ / ▼ / ◀ SEEK ▶ to adjust between the left and right speakers.

Setting the clock: Press and hold CLK until the hours start to flash, then use ▲ / ▼ / ◀ SEEK ▶ to adjust. To adjust minutes, press CLK again to make the minutes start to flash and use ▲ / ▼ / ◀ SEEK ▶ to adjust. Press CLK again to exit the clock setting mode.

3. **SEEK:** Press ◀ SEEK ▶ to access the previous/next strong station.



4. **Memory presets:** To set a station: Select frequency band AM/FM1/FM2; tune to a station, press and hold a preset button until sound returns. You may store up to six stations in each frequency band for a total of 18.



5. **AM/FM:** Press AM/FM to select AM/FM1/FM2 frequency band.



6. **ON/OFF/Volume:** Press VOL - PUSH to turn ON/OFF. Turn VOL - PUSH to increase/decrease volume.

VOL - PUSH



7. **CLK (Clock):** Press CLK to toggle between the clock and radio frequency.



Entertainment Systems

AM/FM stereo single CD/satellite-compatible sound system (if equipped)

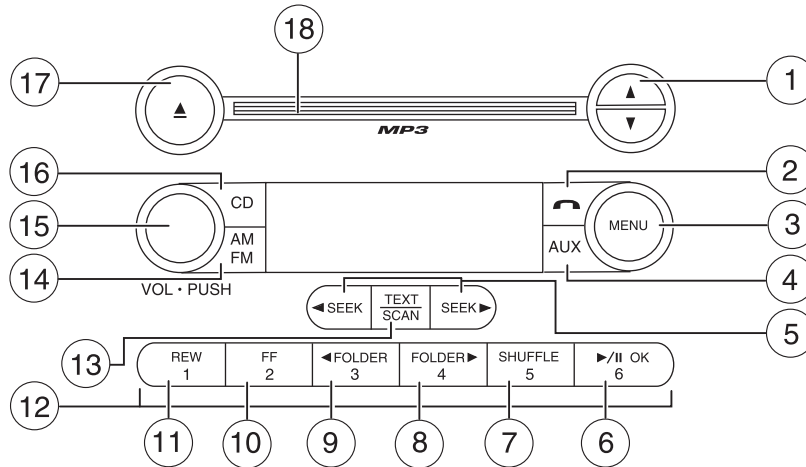

⚠ WARNING: Driving while distracted can result in loss of vehicle control, accident and injury. Ford strongly recommends that drivers use extreme caution when using any device or feature that may take their focus off the road. Your primary responsibility is the safe operation of the vehicle. We recommend against the use of any handheld device while driving and that you comply with all applicable laws.

Accessory delay: Your vehicle is equipped with accessory delay which allows you to operate the window switches and the audio for up to 10 minutes after the ignition has been turned off or until either front door is opened.

1. ▲ / ▼ : Press ▲ / ▼ to manually go up or down the radio frequency. Press and hold for a fast advance through radio frequencies.



In satellite radio mode (if equipped), press ▲ / ▼ to tune to the next/previous channel.

Satellite radio is available only with a valid SIRIUS® radio subscription. Check with your authorized dealer for availability.

62

Entertainment Systems

2. **☎ (Phone):** If your vehicle is equipped with SYNC®, press to access SYNC PHONE features. For further information, please refer to your SYNC® supplement. If your vehicle is not equipped with SYNC®, the display will read NO PHONE.



3. **MENU:** Press MENU repeatedly to access to the following settings:



Setting the clock: Press MENU until SET HOUR or SET MINUTES is displayed. Use ▲ / ▼ / ◀ SEEK, SEEK ▶ to adjust the hours/minutes.

SATELLITE RADIO MENU (if equipped): Press MENU when satellite radio mode is active to access. Press OK to enter into the satellite radio menu. Press ▲ / ▼ to cycle through the following options:

- **CATEGORY:** Press OK to enter category mode. Press ▲ / ▼ to scroll through the list of available SIRIUS® channel Categories (Pop, Rock, News, etc.) Press OK when the desired category appears in the display. After a category is selected, press SEEK to search for that specific category of channels only (i.e. ROCK). You may also select CATEGORY ALL to seek all available SIRIUS® categories and channels. Press OK to close and return to the main menu.
- **SAVE SONG:** Press OK to save the currently playing song title in the system's memory. (If you try to save something other than a song, CANT SAVE will appear in the display.) When the chosen song is playing on any satellite radio channel, the system will alert you with an audible prompt. Press OK while SONG ALERT is in the display and the system will take you to the channel playing the desired song. You can save up to 20 song titles. If you attempt to save a song when the system is full, the display will read REPLACE SONG? Press OK to access the saved songs and press ▲ / ▼ to cycle through the saved songs. When the song appears in the display that you would like to replace, press OK. SONG REPLACED will appear in the display.

Entertainment Systems

- **DELETE SONG:** Press OK to delete a song title from the system's memory. Press ▲ / ▼ to cycle through the saved songs. When the song title appears in the display that you would like to delete, press OK. The song will appear in the display for confirmation. Press OK again and the display will read SONG DELETED. If you do not want to delete the currently listed song, press ▲ / ▼ to select either RETURN or CANCEL.
Note: If there are no songs presently saved, the display will read NO SONGS.
- **DELETE ALL SONGS:** Press OK to delete all songs from the system's memory. The display will read ARE YOU SURE? Press OK to confirm deletion of all saved songs and the display will read ALL DELETED.
Note: If there are no songs presently saved, the display will read NO SONGS.
- **ENABLE ALERTS / DISABLE ALERTS:** Press OK to enable/disable the satellite alert status which alerts you when your selected songs are playing on a satellite radio channel. (The system default is disabled.) SONG ALERTS ENABLED/DISABLED will appear in the display. The menu listing will display the opposite state. For example, if you have chosen to enable the song alerts, the menu listing will read DISABLE as the alerts are currently on, so your other option is to turn them off.

Satellite radio is available only with a valid SIRIUS® radio subscription. Check with your authorized dealer for availability.

AUTOSET: Press MENU until the display reads AUTOSET. Autoset allows you to set the strongest local radio stations without losing your original manually set preset stations for AM/FM1/FM2. Use ▲ / ▼ / ◀ SEEK, SEEK ▶ to turn on/off.

When the six strongest stations are filled, the station stored in preset 1 will begin playing. If there are less than six strong stations, the system will store the last one in the remaining presets.

BASS: Press MENU to reach the bass setting. Use ▲ / ▼ / ◀ SEEK, SEEK ▶ to adjust.

TREB (Treble): Press MENU to reach the treble setting. Use ▲ / ▼ / ◀ SEEK, SEEK ▶ to adjust.

Entertainment Systems

L . . R (Balance): Press MENU to reach the balance setting.

Use ▲ / ▼ / ◀ SEEK, SEEK ▶ to adjust the audio between the left (L) and right (R) speakers.

B . . F (Fade): Press MENU to reach the fade setting. Use ▲ / ▼ / ◀ SEEK, SEEK ▶ to adjust the audio between the back (B) and front (F) speakers.

FADE: Press MENU to reach the fade setting. Use ▲ / ▼ / ◀ SEEK, SEEK ▶ to adjust the audio between the back (B) and front (F) speakers.

SPEEDVOL (Speed sensitive volume, if equipped): Press MENU to reach the SPEEDVOL setting. Radio volume automatically gets louder with increasing vehicle speed to compensate for road and wind noise.

Use ▲ / ▼ / ◀ SEEK, SEEK ▶ to adjust.

The default setting is *off*; increasing your vehicle speed will not change the volume level.

Adjust 1–7: Increasing this setting from 1 (lowest setting) to 7 (highest setting) allows the radio volume to automatically change slightly with vehicle speed to compensate for road and wind noise.

Recommended level is 1–3; SPEED OFF turns the feature off and level 7 is the maximum setting.

Track/Folder mode: Available only on MP3 discs in CD mode. In Track mode, pressing ◀ SEEK, SEEK ▶ will scroll through all tracks on the disc

In Folder mode, pressing ◀ SEEK, SEEK ▶ will scroll only through tracks within the selected folder.

Press ◀ FOLDER, FOLDER ▶ to access the previous/next folder (if available).

COMPRESS (Compression): Available only in CD/MP3 mode. Press MENU until COMPRESS ON/OFF appears in the display.

Use ▲ / ▼ / ◀ SEEK, SEEK ▶ to toggle ON/OFF. When COMPRESS is ON, the system will bring the soft and loud CD passages together for a more consistent listening level.

Entertainment Systems

4. **AUX:** Press repeatedly to cycle through LINE IN (auxiliary audio mode, if equipped) and SAT1, SAT2 and SAT3 modes (satellite radio, if equipped). For location and further information on auxiliary audio mode, refer to *Auxiliary input jack* later in this chapter. *Satellite radio is available only with a valid SIRIUS® radio subscription. Check with your authorized dealer for availability.*



5. **SEEK: In radio mode,** press ◀ / ▶ to access the previous/next strong station.



In CD/MP3 mode, press ◀ / ▶ to access the previous/next CD/MP3 track.

In satellite radio mode (if equipped), press ◀ SEEK, SEEK ▶ to seek to the previous/next channel. If a specific category is selected, (Jazz, Rock, News, etc.), press ◀ SEEK, SEEK ▶ to seek to the previous/next channel in the selected category. Press and hold ◀ SEEK, SEEK ▶ to fast seek through the previous /next channels. In TEXT MODE, press ◀ SEEK, SEEK ▶ to view the previous/additional display text. In CATEGORY MODE, press ◀ SEEK, SEEK ▶ to select a category. *Satellite radio is available only with a valid SIRIUS® radio subscription. Check with your authorized dealer for availability.*

6. ▶ / || **OK (Play/Pause):** This control is operational in CD/MP3 mode. When a CD/MP3 is playing, press to pause or play the current CD/MP3. The CD/MP3 status will display in the radio display.



OK: Use in various menu selections.

If your vehicle is equipped with a Family Entertainment System (FES) please refer to the *Family entertainment DVD system* section later in this chapter.

7. **SHUFFLE:** In CD/MP3 mode, press SHUFFLE to engage shuffle mode. SHUFFLE ON will appear in the display. If you wish to engage shuffle mode right away, press SEEK to begin random play. Otherwise, random play will begin when the





66



Entertainment Systems

current track is finished playing. CD SHUF will appear in the display. To disengage, press SHUFFLE again. SHUFFLE OFF will appear in the display.

Note: In CD/MP3 mode, press SHUFFLE to play the tracks in random order. In MP3 folder mode, the system will randomly play all tracks within the current folder.

8. **FOLDER**  : In folder mode, press FOLDER  to access next folder on MP3 discs, if available.



9.  **FOLDER**: In folder mode, press  FOLDER to access the previous folder on MP3 discs, if available.



10. **FF (Fast forward)**: Press FF to manually advance in a CD/MP3 track.



11. **REW (Rewind)**: Press REW to manually reverse in a CD/MP3 track.



12. **Memory presets:** To set a station: Select frequency band AM/FM1/FM2; tune to a station, press and hold a preset control until sound returns. You may store up to six stations in each frequency band for a total of 18.



In satellite radio mode (if equipped), there are 18 available presets, six each for SAT1, SAT2 and SAT3. To save satellite channels in your memory presets, tune to the desired channel then press and hold a preset control until sound returns.

Satellite radio is available only with a valid SIRIUS® radio subscription. Check with your authorized dealer for availability.

13. **TEXT/SCAN:** In radio and CD/MP3 mode, press and hold for a brief sampling of radio stations or CD tracks. Press again to stop.



In CD/MP3 mode, press and release to display track title, artist name, and disc title.

Entertainment Systems

In satellite radio mode (if equipped), press and release to enter TEXT MODE and display the current song title. While in TEXT MODE, press again to scroll through the current song title, artist, channel category and the SIRIUS® long channel name.

In TEXT MODE sometimes the display requires additional text to be displayed. When the “>” indicator is active, press SEEK ► to view the additional display text. When the “<” indicator is active, press ◀ SEEK to view the previous display text.

In satellite radio mode (if equipped), press and hold to hear a brief sampling of the next channels. Press again to stop. In CATEGORY MODE, press SCAN to hear a brief sampling of the channels in the selected category. Press again to stop.

Satellite radio is available only with a valid SIRIUS® radio subscription. Check with your authorized dealer for availability.

14. **AM/FM:** Press AM/FM to select AM/FM1/FM2 frequency band.



15. **ON/OFF/Volume:** Press VOL-PUSH to turn on/off. Turn VOL-PUSH to increase/decrease volume.



Note: If the volume is set above a certain level and the ignition is turned off, the volume will come back on at a “nominal” listening level when the ignition switch is turned back on.

16. **CD:** Press to enter CD/MP3 mode. If a CD is already loaded into the system, CD/MP3 play will begin where it ended last.



17. **▲ (CD eject):** Press to eject a CD.



18. **CD slot:** Insert a CD label side up in the CD slot.



Entertainment Systems

Auxiliary input jack (if equipped)



WARNING: Driving while distracted can result in loss of vehicle control, accident and injury. Ford strongly recommends that drivers use extreme caution when using any device or feature that may take their focus off the road. Your primary responsibility is the safe operation of the vehicle. We recommend against the use of any handheld device while driving and that you comply with all applicable laws.

Your vehicle may be equipped with an auxiliary input jack (AIJ). The auxiliary input jack, located on the instrument panel below the power point, provides a way to connect your portable music player to the in-vehicle audio system. This allows the audio from a portable music player to be played through the vehicle speakers with high fidelity.

To achieve optimal performance, please observe the following instructions when attaching your portable music device to the audio system.

If your vehicle is equipped with a navigation system, refer to the *Auxiliary input jack* section in the *Audio Features* chapter of your *Navigation System* supplement.

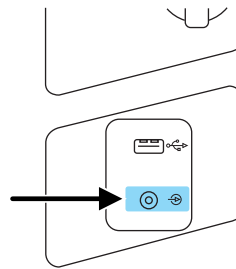

Required equipment:

1. Any portable music player designed to be used with headphones
2. An audio extension cable with stereo male 1/8 in. (3.5 mm) connectors at each end

To play your portable music player using the auxiliary input jack:

1. Begin with the vehicle parked and the radio turned off.
2. Ensure that the battery in your portable music player is new or fully charged and that the device is turned off.
3. Attach one end of the audio extension cable to the headphone output of your player and the other end of the audio extension cable to the AIJ in your vehicle.

Entertainment Systems

4. Turn the radio on, using either a tuned FM station or a CD loaded into the system. Adjust the volume to a comfortable listening level.
5. Turn the portable music player on and adjust the volume to 1/2 the volume.
6. Press AUX on the vehicle radio repeatedly until LINE, LINE IN or SYNC LINE IN appears in the display.
You should hear audio from your portable music player although it may be low.
7. Adjust the sound on your portable music player until it reaches the level of the FM station or CD by switching back and forth between the AUX and FM or CD controls.

Troubleshooting:

1. Do not connect the audio input jack to a line level output. Line level outputs are intended for connection to a home stereo and are not compatible with the AIJ. The AIJ will only work correctly with devices that have a headphone output with a volume control.
2. Do not set the portable music player's volume level higher than is necessary to match the volume of the CD or FM radio in your audio system as this will cause distortion and will reduce sound quality. Many portable music players have different output levels, so not all players should be set at the same levels. Some players will sound best at full volume and others will need to be set at a lower volume.
3. If the music sounds distorted at lower listening levels, turn the portable music player volume down. If the problems persist, replace or recharge the batteries in the portable music player.
4. The portable music player must be controlled in the same manner when it is used with headphones as the AIJ does not provide control (play, pause, etc.) over the attached portable music player.
5. For safety reasons, connecting or adjusting the settings on your portable music player should not be attempted while the vehicle is moving. Also, the portable music player should be stored in a secure location, such as the center console or the glove box, when the vehicle is in motion. The audio extension cable must be long enough to allow the portable music player to be safely stored while the vehicle is in motion.

Entertainment Systems

USB port (if equipped)



WARNING: Driving while distracted can result in loss of vehicle control, accident and injury. Ford strongly recommends that drivers use extreme caution when using any device or feature that may take their focus off the road. Your primary responsibility is the safe operation of the vehicle. We recommend against the use of any handheld device while driving and that you comply with all applicable laws.

Your vehicle may be equipped with a USB port located on the instrument panel. This feature allows you to plug in media playing devices, memory sticks, and also to charge devices if they support this feature. For further information on this feature, refer to *Accessing and using your USB port* in the SYNC® supplement or *Navigation System* supplement.

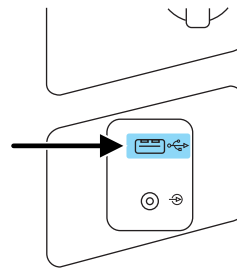

GENERAL AUDIO INFORMATION

Radio frequencies:

AM and FM frequencies are established by the Federal Communications Commission (FCC) and the Canadian Radio and Telecommunications Commission (CRTC). Those frequencies are:

AM: 530, 540–1700, 1710 kHz

FM: 87.7, 87.9–107.7, 107.9 MHz

Radio reception factors:

There are three factors that can affect radio reception:

- Distance/strength: The further you travel from an FM station, the weaker the signal and the weaker the reception.
- Terrain: Hills, mountains, tall buildings, power lines, electric fences, traffic lights and thunderstorms can interfere with your reception.
- Station overload: When you pass a broadcast tower, a stronger signal may overtake a weaker one and play while the weak station frequency is displayed.

Entertainment Systems

CD/CD player care

Do:

- Handle discs by their edges only. (Never touch the playing surface).
- Inspect discs before playing.
- Clean only with an approved CD cleaner.
- Wipe discs from the center out.



Don't:

- Expose discs to direct sunlight or heat sources for extended periods of time.
- Clean using a circular motion.

CD units are designed to play commercially pressed 4.75 in (12 cm) audio compact discs only. Due to technical incompatibility, certain recordable and re-recordable compact discs may not function correctly when used in Ford CD players.

Do not use any irregular shaped CDs or discs with a scratch protection film attached.

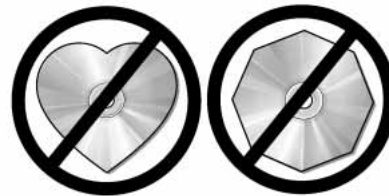

Entertainment Systems

CDs with homemade paper (adhesive) labels should not be inserted into the CD player as the label may peel and cause the CD to become jammed. It is recommended that homemade CDs be identified with permanent felt tip marker rather than adhesive labels. Ballpoint pens may damage CDs. Please contact your authorized dealer for further information.

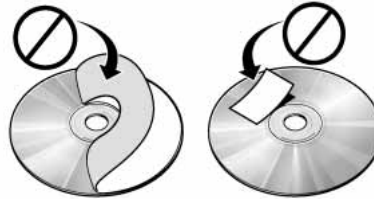

Audio system warranty and service

Refer to the *Warranty Guide/Customer Information Guide* for audio system warranty information. If service is necessary, see your dealer or qualified technician.

MP3 track and folder structure

Your MP3 system recognizes MP3 individual tracks and folder structure as follows:

- There are two different modes for MP3 disc playback: MP3 track mode (system default) and MP3 folder mode. For more information on track and folder mode, refer to *Sample MP3 structure* in the following section.
- MP3 track mode ignores any folder structure on the MP3 disc. The player numbers each MP3 track on the disc (noted by the .mp3 file extension) from T001 to a maximum of T255.
Note: The maximum number of playable MP3 files may be less depending on the structure of the CD and exact model of radio present.
- MP3 folder mode represents a folder structure consisting of one level of folders. The CD player numbers all MP3 tracks on the disc (noted by the .mp3 file extension) and all folders containing MP3 files, from F001 (folder) T001 (track) to F253 T255.
- Creating discs with only one level of folders will help with navigation through the disc files.

Entertainment Systems

Sample MP3 structure

If you are burning your own MP3 discs, it is important to understand how the system will read the structures you create. While various files may be present, (files with extensions other than mp3), only files with the .mp3 extension will be played. Other files will be ignored by the system. This enables you to use the same MP3 disc for a variety of tasks on your work computer, home computer and your in vehicle system.

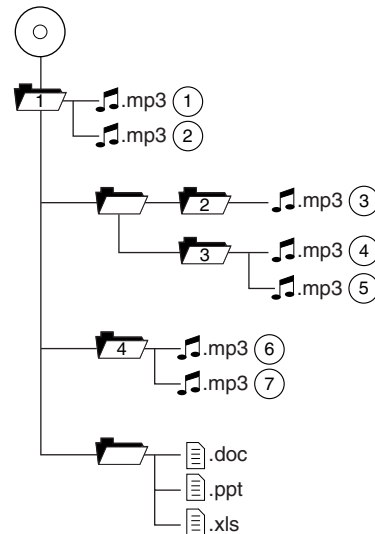

In track mode, the system will display and play the structure as if it were only one level deep (all .mp3 files will be played, regardless of being in a specific folder). In folder mode, the system will only play the .mp3 files in the current folder.

Satellite radio information (if equipped)

Satellite radio channels: SIRIUS® broadcasts a variety of music, news, sports, weather, traffic and entertainment satellite radio channels. For more information and a complete list of SIRIUS® satellite radio channels, visit www.sirius.com in the United States, www.sirius-canada.ca in Canada, or call SIRIUS® at 1-888-539-7474.

Satellite radio reception factors: To receive the satellite signal, your vehicle has been equipped with a satellite radio antenna located on the roof of your vehicle. The vehicle roof provides the best location for an unobstructed, open view of the sky, a requirement of a satellite radio system. Like AM/FM, there are several factors that can affect satellite radio reception performance:

- Antenna obstructions: For optimal reception performance, keep the antenna clear of snow and ice build-up and keep luggage and other material as far away from the antenna as possible.

Entertainment Systems

- **Terrain:** Hills, mountains, tall buildings, bridges, tunnels, freeway overpasses, parking garages, dense tree foliage and thunderstorms can interfere with your reception.
- **Station overload:** When you pass a ground based broadcast repeating tower, a stronger signal may overtake a weaker one and result in an audio mute.

Unlike AM/FM audible static, you will hear an audio mute when there is a satellite radio signal interference. Your radio display may display NO SIGNAL to indicate the interference.

SIRIUS® satellite radio service: SIRIUS® satellite radio is a subscription based satellite radio service that broadcasts music, sports, news and entertainment programming. A service fee is required in order to receive SIRIUS® service. Vehicles that are equipped with a factory installed SIRIUS® satellite radio system include hardware and a limited subscription term, which begins on the date of sale or lease of the vehicle.

For information on extended subscription terms, the online media player and other SIRIUS® features, please contact SIRIUS® at 1-888-539-7474.

Note: SIRIUS® reserves the unrestricted right to change, rearrange, add or delete programming including canceling, moving or adding particular channels, and its prices, at any time, with or without notice to you. Ford Motor Company shall not be responsible for any such programming changes.

Satellite radio electronic serial number (ESN): This 12-digit Satellite Serial Number is needed to activate, modify or track your satellite radio account. You will need this number when communicating with SIRIUS®. While in satellite radio mode, you can view this number on the radio display by pressing the AUX and preset 1 controls simultaneously.

Entertainment Systems

Radio Display	Condition	Action Required
ACQUIRING	Radio requires more than two seconds to produce audio for the selected channel.	No action required. This message should disappear shortly.
SAT FAULT	Internal module or system failure present.	If this message does not clear within a short period of time, or with an ignition key cycle, your receiver may have a fault. See your authorized dealer for service.
INVALID CHNL	Channel no longer available.	This previously available channel is no longer available. Tune to another channel. If the channel was one of your presets, you may choose another channel for that preset button.
UNSUBSCRIBED	Subscription not available for this channel.	Contact SIRIUS® at 1-888-539-7474 to subscribe to the channel or tune to another channel.
NO TEXT	Artist information not available.	Artist information not available at this time on this channel. The system is working properly.
NO TEXT	Song title information not available.	Song title information not available at this time on this channel. The system is working properly.

Entertainment Systems

Radio Display	Condition	Action Required
NO TEXT	Category information not available.	Category information not available at this time on this channel. The system is working properly.
NO SIGNAL	Loss of signal from the SIRIUS® satellite or SIRIUS® tower to the vehicle antenna.	You are in a location that is blocking the SIRIUS® signal (i.e., tunnel, under an overpass, dense foliage, etc). The system is working properly. When you move into an open area, the signal should return.
UPDATING	Update of channel programming in progress.	No action required. The process may take up to three minutes.
CALL SIRIUS® 1-888-539-7474	Satellite service has been deactivated by SIRIUS® satellite radio.	Call SIRIUS® at 1-888-539-7474 to re-activate or resolve subscription issues.

NAVIGATION SYSTEM (IF EQUIPPED)

Your vehicle may be equipped with a navigation system. Refer to the *Navigation System* supplement for further information.

SYNC® (IF EQUIPPED)

Your vehicle may be equipped with SYNC®, a hands-free communications and entertainment system with special phone and media features. For more information, please refer to the *SYNC®* supplement or to the *SYNC®* section in the *Navigation System* supplement (if equipped).





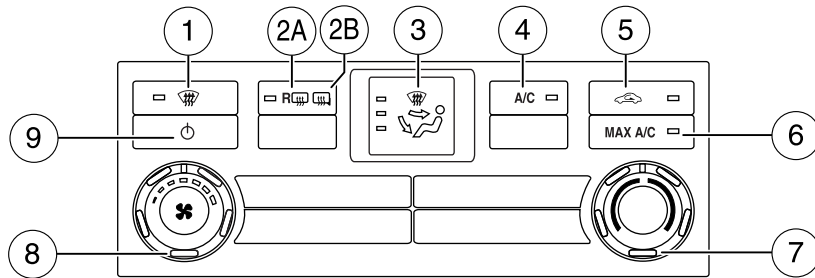

Climate Controls

SINGLE ZONE CLIMATE CONTROL





1. **Defrost:** Distributes outside air through the windshield defroster vents and de-mister vents. Can be used to clear the windshield of fog and thin ice. The system will automatically provide outside air to reduce window fogging. Press this button again to return to the previous air flow selection.
2. A. **Rear defroster (if equipped):** Press to activate/deactivate the rear window defroster. Refer to *Rear window defroster* later in this chapter for more information. If your vehicle is equipped with both rear defroster and heated mirrors, the same button will activate both.
2. B. **Heated mirrors (if equipped):** Press to activate/deactivate. This feature will remove ice and snow from the side view mirrors.
3. **Multifunction control:** Press repeatedly to cycle through the settings to choose:
 - : Distributes air through the windshield defroster vents, de-mister vents, floor vents and rear seat floor vents. The system will automatically provide outside air to reduce window fogging.
 - : Distributes air through the instrument panel vents.
 - : Distributes air through the instrument panel vents, floor vents, rear seat floor vents and de-mister vents.
 - : Distributes air through the floor vents and rear seat floor vents.
4. **A/C (if equipped):** Press to activate/deactivate air conditioning. Use with recirculated air to improve cooling performance and efficiency. A/C engages automatically in MAX A/C, (defrost) and (floor/defrost).

Climate Controls

5.  **Recirculated air (if equipped):** Press to activate/deactivate air recirculation in the vehicle. Recirculated air may reduce the amount of time needed to cool down the interior of the vehicle and may also help reduce undesired odors from reaching the interior of the vehicle. Recirculated air engages automatically when MAX A/C is selected or can be engaged manually in any airflow mode except  (defrost). When the ignition switch is turned off and back on, the climate system will return to the recirculated air mode only if the A/C button LED is illuminated and the air distribution selection is either  (panel) or  (panel/floor).
6. **MAX A/C (if equipped):** Distributes recirculated air through the instrument panel vents to cool the vehicle. This re-cooling of the interior air is more economical and efficient than normal A/C mode. Recirculated air may also help reduce undesirable odors from entering the vehicle. Press the MAX A/C button again for normal A/C operation.
7. **Temperature control:** Controls the temperature of the airflow in the vehicle.
8.  **Fan speed adjustment:** Controls the volume of air circulated in the vehicle.
9.  **Power:** Press to activate/deactivate the climate control system. When the system is off, outside air is prevented from entering the vehicle.

Operating tips

- To reduce fog build-up on the windshield during humid weather, select  (defrost) or  (floor/defrost). Temperature and/or fan speed can also be increased to improve clearing.
- To reduce humidity build-up inside the vehicle: do not drive with the system off or with recirculated air engaged.
- Do not put objects under the front seats that will interfere with the airflow to the back seats.
- Remove any snow, ice or leaves from the air intake area at the base of the windshield.
- To improve the A/C cool down, drive with the windows slightly open for 2-3 minutes after start up or until the vehicle has been “aired out.”

Climate Controls

- If you are driving during extreme high ambient temperatures and idling for extended periods of time in gear, it is recommended to run the A/C in the MAX A/C position, adjust the blower fan speed to the lowest setting and put the vehicle's transmission into the P (Park) position to continue to receive cool air from your A/C system.
- A small amount of air may be felt from the floor vent regardless of the air distribution setting that is selected.

If you are driving during extreme high ambient temperatures and idling for extended periods of time in gear, it is recommended to run the A/C in the MAX A/C position, adjust the blower fan speed to the lowest setting and put the vehicle's transmission into the P (Park) position to continue to receive cool air from your A/C system.

For maximum cooling performance (MAX A/C):

MAX A/C mode:

- Move the temperature control to the coolest setting.
- Set the fan to the highest speed initially, then adjust to maintain comfort.

 (Panel) and  (panel/floor) modes:

- Move the temperature control to the coolest setting.
- Select A/C and  (recirculated air). Use recirculated air with A/C to provide colder airflow.
- Set the fan to the highest speed initially, then adjust to maintain comfort.

To aid in side window defogging/demisting in cold weather:

1. Select  (panel/floor).
2. Select A/C.
3. Adjust the temperature control to maintain comfort.
4. Set the fan speed to the highest setting.
5. Direct the outer instrument panel vents towards the side windows.

To increase airflow to the outer instrument panel vents, close the vents located in the middle of the instrument panel.

Climate Controls



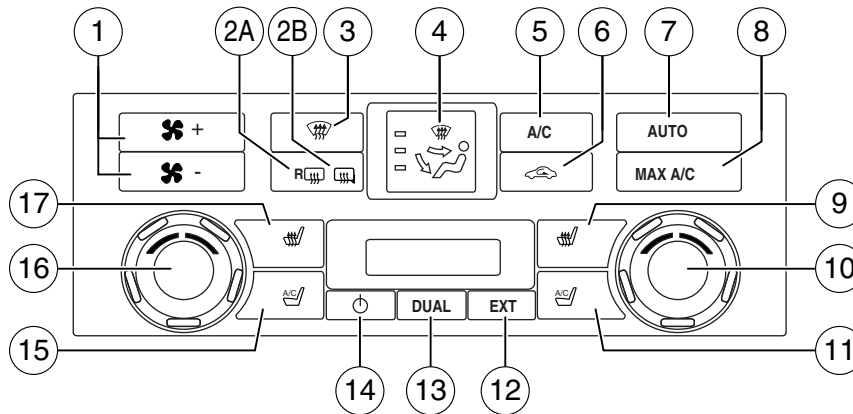







DUAL ZONE AUTOMATIC TEMPERATURE CONTROL (IF EQUIPPED)





Temperature conversion: To switch between Fahrenheit and Celsius, refer to *Optional or Standard message center* in the *Instrument Cluster* chapter.

1. **Fan speed control:** Press to decrease/increase the fan speed.
2. A. **Rear defroster (if equipped):** Press to activate/deactivate the rear window defroster. Refer to *Rear window defroster* later in this chapter for more information. If your vehicle is equipped with both rear defroster and heated mirrors, the same button will activate both.
2. B. **Heated mirrors (if equipped):** Press to activate/deactivate. This feature will remove ice and snow from the side view mirrors.
3. **Defrost:** Distributes outside air through the windshield defroster vents and de-mister vents. Can be used to clear the windshield of fog and thin ice. The system will automatically provide outside air to reduce window fogging. Press this button again to return to the previous air flow selection.
4. **Manual control:** Allows you to manually select where airflow is directed. To return to full automatic control, press AUTO. When choosing to control airflow manually, press repeatedly to toggle through the settings to choose:
 - : Distributes air through the windshield defroster vents, de-mister vents, floor vents and rear seat floor vents. The system will automatically provide outside air to reduce window fogging.
 - : Distributes air through the instrument panel vents.



Climate Controls

-  : Distributes air through the instrument panel vents, floor vents, rear seat floor vents and de-mister vents.
 -  : Distributes air through the floor vents and rear seat floor vents.
5. **A/C**: Press to activate/deactivate air conditioning. Use with recirculated air to improve cooling performance and efficiency. A/C engages automatically in MAX A/C,  (defrost) and  (floor/defrost).
6.  **Recirculated air**: Press to activate/deactivate air recirculation in the vehicle. Recirculated air may reduce the amount of time needed to cool down the interior of the vehicle and may also help reduce undesired odors from reaching the interior of the vehicle. Recirculated air engages automatically when MAX A/C is selected or can be engaged manually in any airflow mode except  (defrost). When the ignition switch is turned off and back on, the climate system will return to the recirculated air mode only if the A/C button LED is illuminated and the air distribution selection is either  (panel) or  (panel/floor).
7. **AUTO**: Press to engage automatic temperature control. Select the desired temperature using the temperature control. The system will automatically determine fan speed, airflow location, A/C on or off, and outside or recirculated air, to heat or cool the vehicle to reach the desired temperature.
8. **MAX A/C**: Distributes recirculated air through the instrument panel vents to cool the vehicle. This re-cooling of the interior air is more economical and efficient than normal A/C mode. Recirculated air may also help reduce undesirable odors from entering the vehicle. Press the MAX A/C button again for normal A/C operation.
9.  **Passenger heated seat (if equipped)**: Press to control the passenger heated seat. Refer to *Heated and cooled seats* in the *Seating and Safety Restraints* chapter for more information.
10. **Passenger temperature**: Turn to increase/decrease the air temperature on the passenger side of the vehicle. The recommended initial setting is between 72°F (22°C) and 75°F (24°C), then adjust for comfort. The passenger side temperature setting will appear in the upper right corner of the display.
11.  **Passenger cooled seat (if equipped)**: Press to control the passenger cooled seat. Refer to *Heated and cooled seats* in the *Seating and Safety Restraints* chapter for more information.
12. **EXT**: Press to display the exterior temperature. Press again to display cabin temperature settings. To switch between Fahrenheit and Celsius, refer to *Message center* in the *Instrument Cluster* chapter.

Climate Controls

13. **DUAL:** Press to engage/disengage separate passenger side temperature control.
14.  **Power:** Press to activate/deactivate the climate control system. When the system is off, outside air is prevented from entering the vehicle.
15.  **Driver cooled seat (if equipped):** Press to control the driver cooled seat. Refer to *Heated and cooled seats* in the *Seating and Safety Restraints* chapter for more information.
16. **Driver temperature:** Turn to increase/decrease the air temperature on the driver side of the vehicle. The control also adjusts the passenger side temperature when PASS TEMP is disengaged. The recommended initial setting is between 72°F (22°C) and 75°F (24°C), then adjust for comfort. The driver side temperature setting will appear in the upper left corner of the display.
17.  **Driver heated seat (if equipped):** Press to control the driver heated seat. Refer to *Heated and cooled seats* in the *Seating and Safety Restraints* chapter for more information.



Operating tips

- To reduce fog build-up on the windshield during humid weather, select  (defrost)  (floor/defrost).
- To reduce humidity build-up inside the vehicle, do not drive with the system off, or with  (recirculated air) engaged and A/C off.
- Do not put objects under the front seats that will interfere with the airflow to the back seats.
- Remove any snow, ice or leaves from the air intake area at the base of the windshield.
- To improve the A/C cool down, drive with the windows slightly open for 2-3 minutes after start up or until the vehicle has been “aired out”.
- A small amount of air may be felt from the floor vent regardless of the air distribution setting that is selected.

During extreme high ambient temperatures when idling stationary for extended periods of time in gear, it is recommended to run the A/C in the max A/C position, reduce blower fan speed from the highest setting and put the vehicle's transmission into the P (PARK) gear position (automatic transmission only) to continue to receive cool air from your A/C system.

Climate Controls

For maximum cooling performance:

- Automatic operation:
 1. Press AUTO for full automatic operation.
 2. Do not override A/C or  (recirculated air).
 3. Set the temperature to 60°F (16°C).
- Manual operation:
 1. Select MAX A/C.
 2. Select  (recirculated air). Use  (recirculated air) with A/C to provide colder airflow.
 3. Set the temperature to 60°F (16°C).
 4. Set highest fan speed initially, then adjust to maintain comfort.

To aid in side window defogging/demisting in cold weather:

1. Select  (panel/floor).
2. Select A/C.
3. Adjust the temperature control to maintain comfort.
4. Set the fan speed to the highest setting.
5. Direct the outer instrument panel vents towards the side windows.

To increase airflow to the outer instrument panel vents, close the vents located in the middle of the instrument panel.

REAR WINDOW DEFROSTER (IF EQUIPPED)

The rear defroster control is located on the climate control panel and works to defrost your rear window from fog and thin ice. If equipped, it also operates the heated mirror to remove snow and thin ice from the side mirrors.

Ensure that the ignition on. Press to turn the defroster on/off. The indicator light will illuminate when activated. For vehicles with a sliding rear window– the defroster will be disabled when the window is opened.

Do not use razor blades or other sharp objects to clean the inside of the rear window or to remove decals from the inside of the rear window. This may cause damage to the heated grid lines and will not be covered by your warranty.

Climate Controls

REMOTE START CLIMATE OPERATION (IF EQUIPPED)

The climate control system will condition the cabin temperature during remote start based on the outside temperature. Engine idle may increase to help with adjusting the cabin temperature.

Note: No climate control adjustments will be recognized during remote start operation. Once the ignition is cycled to the on position, the climate control system will return to the previous settings (last ignition-on cycle) and adjustments can be made normally. If the previous setting was off, the climate control system will turn off.

Manual climate control

For hot weather conditions:

- The climate control system will be set to MAX A/C.

For cold weather conditions:

- The climate control system will be set to provide maximum heating in  (floor/defrost) mode.
- Rear defrost/heated mirrors (if equipped) will be activated.

For moderate weather conditions:

- The interior cabin will be heated, cooled or off, based upon the previous operating state (last ignition-on cycle).
- Rear defrost/heated mirrors (if equipped) will be deactivated.

Automatic climate control

For hot weather conditions:

- The interior cabin will be cooled to 72°F (22°C).
- The cooled seats (if equipped) will be set to high.

For cold weather conditions:

- The interior cabin will be heated to 72°F (22°C).
- The heated seats (if equipped) will be set to high.
- Rear defrost/heated mirrors (if equipped) will be activated.

For moderate weather conditions:

- The interior cabin will be heated, cooled, or off, based upon the previous operating state (last ignition-on cycle).
- Heated/cooled seats (if equipped) will be deactivated.
- Rear defrost/heated mirrors (if equipped) will be deactivated.

Lights

HEADLAMP CONTROL

Rotate the headlamp control clockwise to the first position  to turn on the parking lamps.

Rotate clockwise to the second position  to also turn on the headlamps.

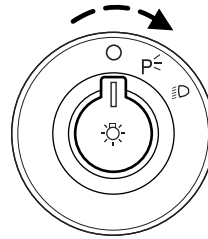

Autolamp control (if equipped)

The autolamp system provides light sensitive automatic on-off control of the exterior lights normally controlled by the headlamp control.

- To turn autolamps on, rotate the control to .
- To turn autolamps off, rotate the control from the autolamp position.

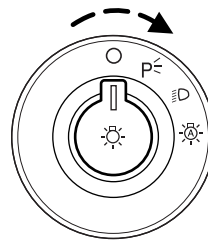

Note: If the vehicle is equipped with autolamps, it will have the *headlamps on with windshield wipers feature*. If the windshield wipers are turned on, the exterior lamps will turn on with the headlamp control in the autolamp position.

The autolamp system also keeps the lights on for a predetermined amount of time after the ignition switch is turned to off. You can change the amount of time the lamps stay on by using the programming procedure that follows:

Autolamps - Programmable exit delay

Programmable exit delay allows the length of the autolamp exit delay to be changed.



To program the auto lamp exit time delay:

1. Start with the ignition in the off position and the headlamp control in the autolamp position.
2. Turn the headlamp control to off.

Lights

3. Turn the ignition switch to on and then back to off.
4. Turn the headlamp control to the autolamp position. The headlamps will turn on.
5. Wait the desired amount of time for the exit delay you want (up to three minutes), then turn the headlamps off.

Fog lamp control (if equipped)

The headlamp control also operates the fog lamps. The fog lamps can be turned on only when the headlamp control is in the ,  or  position and the high beams are not turned on.

Pull headlamp control towards you to turn fog lamps on. The fog lamp indicator light  will illuminate.

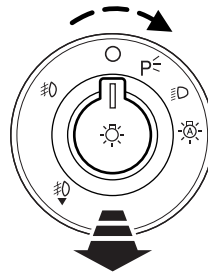

High beams

Pull the lever fully (to second detent) to activate. Pull the lever again to deactivate.

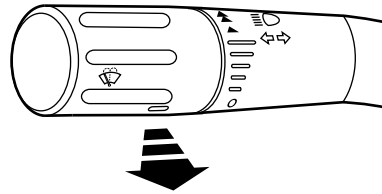

Flash-to-pass

Pull toward you slightly to activate and release to deactivate.

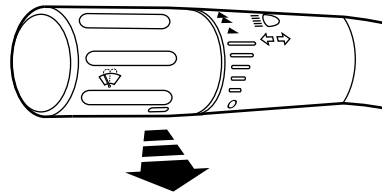

Lights

Daytime running lamps (DRL) (if equipped)

Turns the headlamps on with a reduced output.

To activate:

- the ignition must be in the on position,
- the headlamp control is in the off or parking lamp position and
- the parking brake must be disengaged.



WARNING: Always remember to turn on your headlamps at dusk or during inclement weather. The Daytime Running Lamp (DRL) system does not activate the tail lamps and generally may not provide adequate lighting during these conditions. Failure to activate your headlamps under these conditions may result in a collision.

PANEL DIMMER CONTROL

Use to adjust the brightness of the instrument panel and all applicable lit components in the vehicle during headlamp and parking lamp operation.

- Tap the top or bottom of the control to brighten/dim all interior lit components incrementally, or
- Press and hold at the first position the top or bottom of the control until the desired lighting level is reached.
- Press and hold the top of the control to the full on position to activate the “dome on” feature. This will turn on the interior courtesy lights. The lights will remain on until the bottom of the control is pressed.

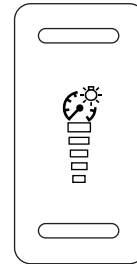

Note: If the battery is disconnected, discharged, or a new battery is installed, the dimmer control requires re-calibration. Press the dimmer control from the full dim position to the full on position to reset. This will ensure that your displays are visible under all lighting conditions.

AIMING THE HEADLAMPS

Your vehicle is equipped with an aerodynamic headlamp system. The aerodynamic headlamps can only be aimed in the vertical direction (up/down) using the procedure following. The headlamps on your vehicle are properly aimed at the assembly plant and should not normally need adjustment.

88

Lights

Vertical aim adjustment

The headlamps on your vehicle can only be vertically adjusted. Your vehicle does not require horizontal aim adjustments.

To adjust the headlamps:

1. Park the vehicle directly in front of a wall or screen on a level surface, approximately 25 feet (7.6 meters) away.

- (1) 8 feet (2.4 meters)
- (2) Center height of lamp to ground
- (3) 25 feet (7.6 meters)
- (4) Horizontal reference line

2. Measure the height from the center of your headlamp (indicated by a 3.0 mm circle on the lens) to the ground and mark an 8 foot (2.4 meter) horizontal reference line on the vertical wall or screen at this height (a piece of masking tape works well).

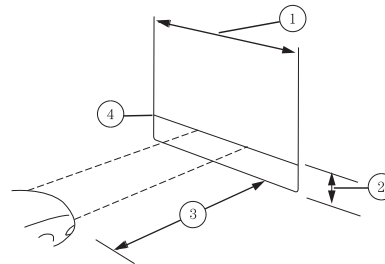

3. Turn on the low beam headlamps to illuminate the wall or screen and open the hood. Cover one of the headlamps so no light from that lamp hits the wall.

4. On the wall or screen you will observe a light pattern with a distinct horizontal edge towards the right. If this edge is not at the horizontal reference line, the beam will need to be adjusted so the edge is at the same height as the horizontal reference line.

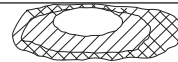

5. Locate the vertical adjuster on each headlamp, then use a #2 Philips head to turn the adjuster either counterclockwise (to adjust down) or clockwise (to adjust up) aligning the upper edge of the light pattern up to the horizontal line.

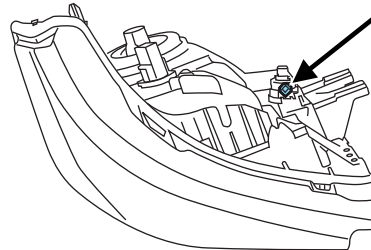

6. Repeat Steps 3–5 for the other headlamp.

7. Close the hood and turn off the lamps.

Lights

TURN SIGNAL CONTROL

The turn signal lever does not mechanically lock in the upward or downward position when activated. The turn signal control activation and cancellation is electronic.

- To operate the left turn signal, push the lever down until it stops and release.
- To operate the right turn signal, push the lever up until it stops and release.
- To manually cancel turn signal operation, push the lever again in either direction.

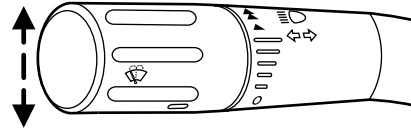

Lane change

To indicate a left or right lane change:

- Push the lever up/down to the first stop position and release. The turn signals will flash three times and stop.
- Push the lever up/down to the first stop position and hold. The turn signals will flash if the lever is held in this position.

INTERIOR LAMPS

Map lamps (if equipped)

To turn on the map lamps, press the control next to each lamp.

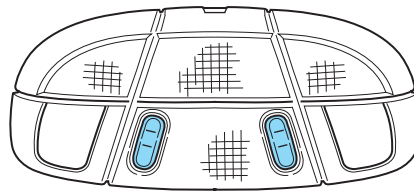

Lights

To turn on the map lamps, press the lamp.

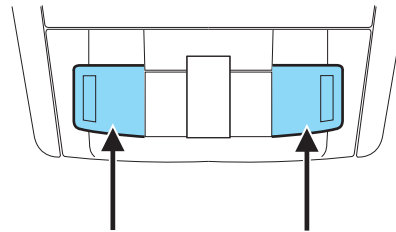

The dome lamp turns on when:

- any door is opened,
- the instrument panel dimmer switch is rotated up until the courtesy lamps come on, and
- any of the remote entry controls are pressed and the ignition is off.

BULB REPLACEMENT

Lamp assembly condensation

Exterior lamps are vented to accommodate normal changes in pressure. Condensation can be a natural by-product of this design. When moist air enters the lamp assembly through the vents, there is a possibility that condensation can occur when the temperature is cold. When normal condensation occurs, a thin film of mist can form on the interior of the lens. The thin mist eventually clears and exits through the vents during normal operation. Clearing time may take as long as 48 hours under dry weather conditions.

Examples of acceptable condensation are:

- Presence of thin mist (no streaks, drip marks or droplets)
- Fine mist covers less than 50% of the lens

Examples of unacceptable moisture (usually caused by a lamp water leak) are:

- Water puddle inside the lamp
- Large water droplets, drip marks or streaks present on the interior of the lens

Take your vehicle to dealer for service if any of the above conditions of unacceptable moisture are present.

Lights

Replacing exterior bulbs

Check the operation of all the bulbs frequently.

Function	Number of bulbs	Trade number
Headlamps	2	H13/9008
Park/Turn lamp	2	3157NA
Sidemarkers	2	W5W
Tail/stop/turn/sidemarkers (pick-up only)	2	3157
Tail/stop/turn/sidemarkers (chassis cabs only; if equipped)	2	3157
Back-up (pick-ups only)	2	921
Back-up (chassis cabs only)	2	3157
High-mount stoplamp	1	922
Fog lamp	2	9145
License plate lamp	2	194
Cargo lamp	2	906
Mirror turn signal	2	2825
Mirror clearance lamp	2	2825
*Front clearance lamps (2) and front identification lamps (3)	5	194
*Rear fender clearance	4	LED**
Interior visor lamp (if equipped)	4	194
*Rear identification	3	193**
To replace all instrument panel lights - see your authorized dealer		
* Dual rear wheels, or if equipped.		
** See your authorized dealer to replace the lamp assembly.		

Replacing headlamps, park lamps, turn lamps

1. Make sure that the exterior lamps are off, then open the hood.

Lights

2. Using masking tape or a marker, make an alignment mark between one of the grille brackets and the vehicle radiator support to ensure correct grille alignment during re-assembly. Do not scratch the black coating from the radiator support.

3. Remove the two grille to headlamp assembly push pins and the four bolts attaching the top of the grille to the radiator support.

4. Pull the top of the grille forward to gain access to the lower grille spring clips.

5. Depress the spring clips through the lower inner grille access openings using a flat head screwdriver.

6. Pull the grill straight out to remove.

7. Remove the four bolts from the headlamp assembly.

8. Pull the assembly straight out disengaging one snap clip from the fender.

9. Disconnect the electrical connector by squeezing the release tab and pushing the connector forward, then pulling it rearward.

10. For the headlamp bulb, remove the bulb by turning it counterclockwise and pulling it straight out.

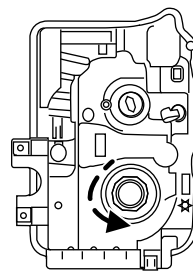
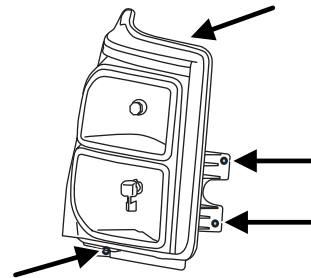
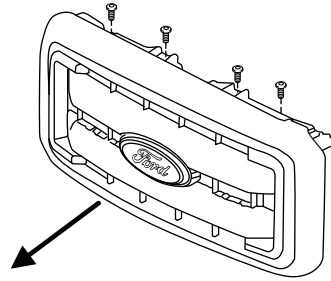

Lights

11. For the park or turn lamp bulb, remove the bulb by turning it counterclockwise and pulling it straight out.

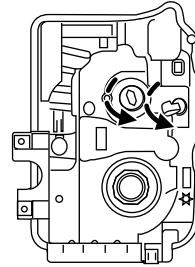

WARNING: Handle a halogen headlamp bulb carefully and keep out of children's reach. Grasp the bulb only by its plastic base and do not touch the glass. The oil from your hand could cause the bulb to break the next time the headlamps are operated.

Install the new bulb(s) in reverse order.

Replacing brake/tail/turn/back-up lamp bulbs (pick-ups only)

1. Make sure the headlamps are off, then open the tailgate to expose the lamp assemblies.

2. Remove the two bolts from the tail lamp assembly and carefully pull the lamp assembly from the tailgate pillar by releasing the two retaining tabs.

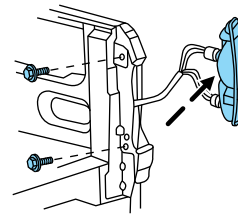

3. Rotate the bulb socket counterclockwise and remove from lamp assembly.

4. Pull the bulb straight out of the socket.

Install the new bulb(s) in reverse order.

Lights

Replacing brake/tail/turn/back-up lamp bulbs (chassis cabs only) (if equipped)

1. Make sure the headlamps are off.
2. Remove the four screws and the lamp lens from lamp assembly.
3. Carefully pull the bulb straight out of the socket and push in the new bulb.

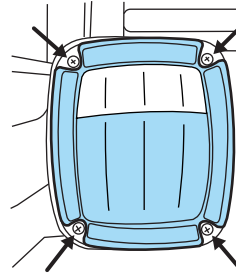

Replacing cargo lamp and high-mount brakelamp bulbs

1. Make sure the headlamps are off.
2. Remove the screws and lamp assembly from the vehicle as wiring permits.
3. Remove the bulb socket by rotating it counterclockwise.
4. Pull the bulb straight out of the socket.

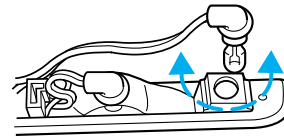
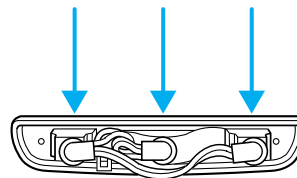

Replacing front clearance and identification lamp bulbs

1. Make sure the headlamps are off.
2. Remove the screw and lens from the lamp assembly.
3. Pull the bulb straight out of the socket.

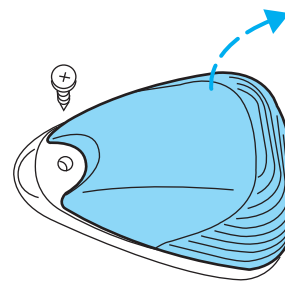

Install the bulb(s) in reverse order.

Lights

Replacing fog lamp bulbs (if equipped)

1. Make sure the headlamps are off.
2. Remove the bulb socket from the fog lamp by turning it counterclockwise.
3. Disconnect the electrical connector from the fog lamp bulb.

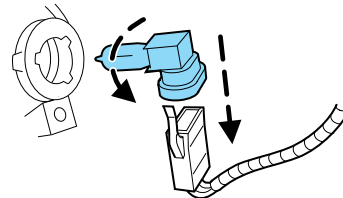

Install the new bulb(s) in reverse order.

Replacing license plate lamp bulbs

The license plate bulbs are located behind the rear bumper. To change the license plate lamp bulbs:

1. Reach behind the rear bumper to locate the bulb.
2. Twist the bulb socket counterclockwise and carefully pull to remove it from the lamp assembly.
3. Pull out the old bulb from the socket and push in the new bulb.
4. Install the bulb socket in lamp assembly by turning it clockwise.

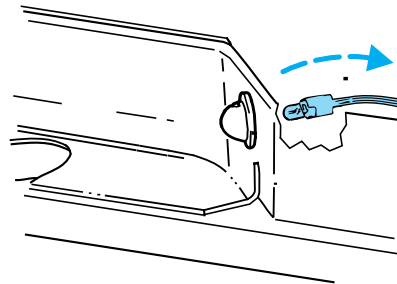

Driver Controls

MULTI-FUNCTION LEVER

Windshield wiper: Rotate the end of the control away from you to increase the speed of the wipers; rotate towards you to decrease the speed of the wipers.

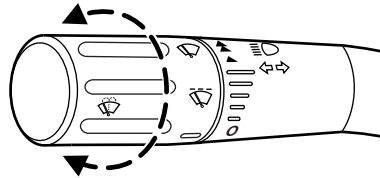

Speed dependent wipers: When the wiper control is set on the intermittent settings, the speed of the wipers will automatically adjust with the vehicle speed. The faster your vehicle is travelling the faster the wipers will go.

Windshield washer: Press the end of the stalk:

- briefly: causes a single swipe of the wipers without washer fluid.
- a quick press and hold: the wipers will swipe three times with washer fluid.
- a long press and hold: the wipers and washer fluid will be activated for up to 10 seconds.

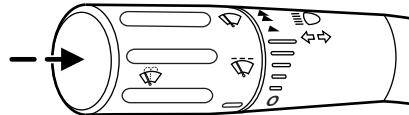

Courtesy wipe feature: One extra wipe will occur a few seconds after washing the front window to clear any excess washer fluid remaining on the windshield.

Note: Do not operate the washer when the washer reservoir is empty. This may cause the washer pump to overheat. Check the washer fluid level frequently. Do not operate the wipers when the windshield is dry. This may scratch the glass, damage the wiper blades and cause the wiper motor to burn out. Before operating the wiper on a dry windshield, always use the windshield washer. In freezing weather, be sure the wiper blades are not frozen to the windshield before operating the wipers.

Windshield wiper rainlamp feature (if equipped with Autolamp)

When the windshield wipers are turned on during daylight, and the headlamp control is in the autolamp position, the exterior lamps will turn on after a brief delay and will remain on until the wipers are turned off.

Driver Controls

TILT/TELESCOPE STEERING WHEEL

To adjust the steering wheel:

1. Pull the lever down to unlock the steering column.
2. While the lever is in the down position, move the steering wheel up or down and in or out until you find the desired position.
3. While holding the steering wheel in place, pull the lever up to its original position to lock the steering column.

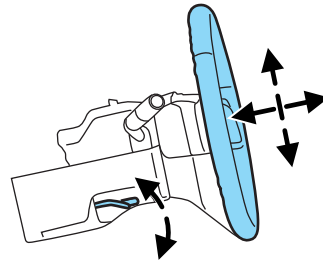

WARNING: Never adjust the steering wheel when the vehicle is moving.

ILLUMINATED VISOR MIRROR (IF EQUIPPED)

Lift the mirror cover to turn on the visor mirror lamp.

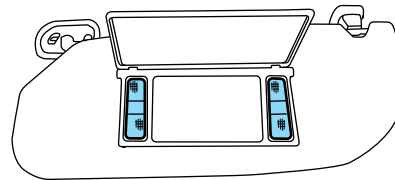

Driver Controls

OVERHEAD CONSOLE (IF EQUIPPED)

The appearance of your vehicle's overhead console will vary according to your option package.

Storage compartment (if equipped)

Press the release tab on the rear edge of the bin door to open the storage compartment. The door will open to the full open position.

The storage compartment may be used to secure sunglasses or a similar object.

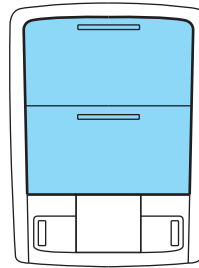

CENTER CONSOLE (IF EQUIPPED)

Your vehicle may be equipped with a variety of console features. These include:

- Locking storage compartment with hanging file folder supports
- Storage for laptop computer, binder or book between the hanging file folder support and the passenger side of the console bin
- Removable cupholders
- Hidden storage compartment (false bottom in storage area under cupholders) that can also be used to hold very large cups
- One 12V power point inside the storage compartment and one on the rear of the console
- 110V AC power point outlet on the rear of the console
- Rear cupholders

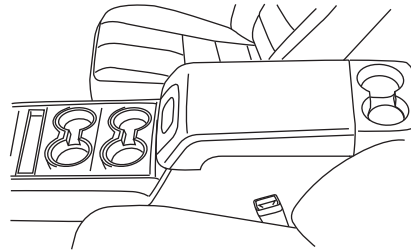

WARNING: Use only soft cups in the cupholder. Hard objects can injure you in a collision.

Driver Controls

AUXILIARY POWER POINT (12V DC)

Power outlets are designed for accessory plugs only. Do not insert any other object in the power outlet for this will damage the outlet and blow the fuse. Do not hang any type of accessory or accessory bracket from the plug. Improper use of the power outlet can cause damage not covered by your warranty.

Auxiliary power points can be found in the following locations:

- On the instrument panel (two locations)
- Inside the center console storage compartment (if equipped)
- On the rear of the center console (if equipped)
- Inside the 20-percent front seat console (if equipped)
- Inside the rear under seat storage compartment (if equipped)

Do not use the power point for operating the cigarette lighter element (if equipped).

To prevent the fuse from being blown, do not use the power point(s) over the vehicle capacity of 12V DC/180W. If the power point or cigar lighter socket is not working, a fuse may have blown. Refer to *Fuses and relays* in the *Roadside Emergencies* chapter for information on checking and replacing fuses.

To have full capacity usage of your power point, the engine is required to be running to avoid unintentional discharge of the battery. To prevent the battery from being discharged:

- do not use the power point longer than necessary when the engine is not running,
- do not leave battery chargers, video game adapters, computers and other devices plugged in overnight or when the vehicle is parked for extended periods.

Always keep the power point caps closed when not being used.

Driver Controls

Power point (110V AC) (if equipped)

The 110V AC power point outlet is used for powering electrical devices that require up to 150W. Exceeding the 150W limit will cause the power point to cut off the power temporarily to provide overload protection.

Note: The 110V AC power point is equipped with a safety cap and a safety twist tab. They both provide protection from inserting any object into the power point other than the 110V AC electrical device plug. The safety cap should always be in a closed position whenever the power point outlet is not in use.

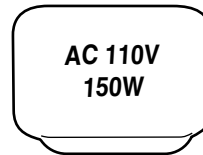

The 110V AC power point is located on the back of the center console.

The power outlet is not designed for the following electric appliances; they may not work properly:

- Cathode ray tube type televisions
- Motor loads, such as vacuum cleaners, electric saws and other electric power tools, compressor-driven refrigerators, etc.
- Measuring devices, which process precise data, such as medical equipment, measuring equipment, etc.
- Other appliances requiring an extremely stable power supply: microcomputer-controlled electric blankets, touch sensor lamps, etc.



WARNING: Do not keep electrical devices plugged in the power point whenever the device is not in use. Do not use any extension cord with the 110V AC power point, since it will defeat the safety protection design provided by the cap and twist tab. Doing so may cause the power point to overload due to powering multiple devices that can reach beyond the 150W load limit and could result in fire or serious injury.

The power point can switch to a fault mode when it is overloaded, overheated, or shorted. For overloading and shorting conditions, unplug your device and turn the ignition key off then on. For an overheating condition, let the system cool off, then turn the ignition key off then on.

Driver Controls

The 110V AC power point can provide power whenever the vehicle ignition is in the on position and the power point green indicator light located in the top left corner is turned on. Refer to the indicator light code below for the power point status.

Indicator light codes

Green light is on — Power point is ready to supply power

Green light is off — Power point power supply is off. Ignition is not in the on position

Green light is blinking — Power point is in fault mode

Note: The 110V AC power point will turn off after 13 minutes if the ignition is in the on position without the engine running. Keep the engine running or cycle the ignition before the 13 minute time-out to keep the inverter on.

POWER WINDOWS (IF EQUIPPED)



WARNING: Do not leave children unattended in the vehicle and do not let children play with the power windows. They may seriously injure themselves.



WARNING: When closing the power windows, you should verify they are free of obstructions and ensure that children and/or pets are not in the proximity of the window openings.

Press and pull the window switches to open and close windows.

- Press down (to the first detent) and hold the switch to open.
- Pull up (to the first detent) and hold the switch to close.

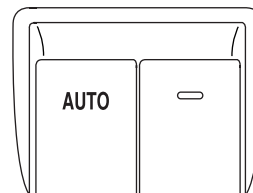

Rear Window Buffeting: When one or both of the rear windows are open, the vehicle may demonstrate a wind throb or buffeting noise. This noise can be alleviated by lowering a front window approximately two to three inches.

Driver Controls

One-touch down

Allows the driver's window to open fully without holding the control down. Press the switch completely down to the second detent and release quickly. The window will open fully. Momentarily press the switch to any position to stop the window operation.

Window lock (if equipped)

The window lock feature allows only the driver to operate the power windows.

To lock out all the window controls (except for the driver's) press the right side of the control. Press the left side to restore the window controls.

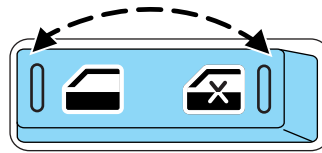

Power sliding back window (if equipped)

The control is located on the overhead console.

Press and hold the  control to open the window all the way to the full open position.

Pull and hold the  control to close the window.

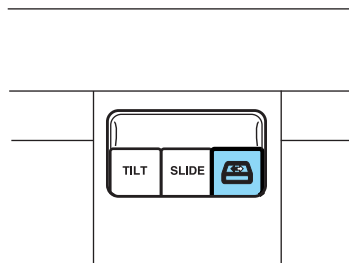

WARNING: When operating the power sliding back window you must ensure all rear seat occupants and/or cargo are not in the proximity of the back window.



WARNING: Do not leave children unattended in the vehicle and do not let children play with the power sliding back window. They may seriously injure themselves.

Accessory delay

With accessory delay, the window switches may be used for up to 10 minutes after the ignition switch is turned to the off position or until either front door is opened.

Driver Controls

INTERIOR MIRROR

The interior rear view mirror has two pivot points on the support arm which lets you adjust the mirror up or down and from side to side.



WARNING: Do not adjust the mirror while the vehicle is in motion.

Automatic dimming interior rear view mirror (if equipped)

Your vehicle may be equipped with an interior rear view mirror which has an auto-dimming function. The electronic day/night mirror will change from the normal (high reflective) state to the non-glare (darkened) state when bright lights (glare) reach the mirror. When the mirror detects bright light from behind the vehicle, it will automatically adjust (darken) to minimize glare.

The mirror will automatically return to the normal state whenever the vehicle is placed in R (Reverse) to ensure a bright clear view when backing up.

Do not block the sensors on the front and back of the interior rear view mirror since this may impair proper mirror performance.

Do not clean the housing or glass of any mirror with harsh abrasives, fuel or other petroleum-based cleaning products.

Note: If equipped with a rearview camera system, a video image will be displayed in the mirror or the navigation system (if equipped) when the vehicle is put in R (Reverse). As you shift into any other gear from R (Reverse), the image will remain for a few seconds and then turn off. Refer to *Rearview camera system* in the *Driving* chapter.

EXTERIOR MIRRORS

Power side view mirrors (if equipped)

To adjust your mirrors:

1. Rotate the control clockwise to adjust the right mirror and rotate the control counterclockwise to adjust the left mirror.
2. Move the control in the direction you wish to tilt the mirror.



Driver Controls

3. Return to the center position to lock mirrors in place.

The spotter mirror below the main glass (if equipped) must be adjusted manually.

Heated outside mirrors (if equipped)

The main mirror glass and lower convex spotter mirror are heated to remove ice, mist and fog. To activate the heated mirrors, press the heated mirror control  located on the climate control panel. The heated mirrors will operate for 10 minutes, then automatically shut off (or shut off when the engine is turned off). In cases of extreme ice and cold, the heater control may need pressing again after 10 minutes in order to fully clear the glass.

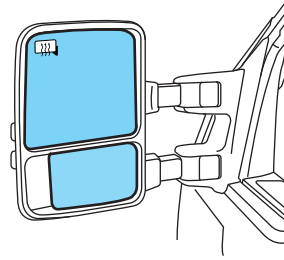

Do not remove ice from the mirrors with a scraper or attempt to re-adjust the mirror glass if it is frozen in place. These actions could cause damage to the glass and mirrors.

Do not clean the housing or glass of any mirror with harsh abrasives, fuel or other petroleum-based cleaning products.

Fold-away mirrors

Fold the side mirrors in carefully before driving through a narrow space, like an automatic car wash.

Powerfold mirrors (if equipped)

You can fold the side mirrors simultaneously using the power mirror switch.

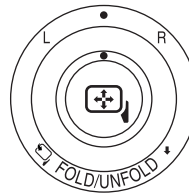

To operate the powerfold mirrors:

1. Rotate the switch to the center/neutral position.
2. Momentarily pull the switch rearward to auto fold in.
3. Momentarily pull the switch rearward again to fold back to design position.

Driver Controls

Note: When powerfolding the mirrors, it is normal to hear the sound of the motors.

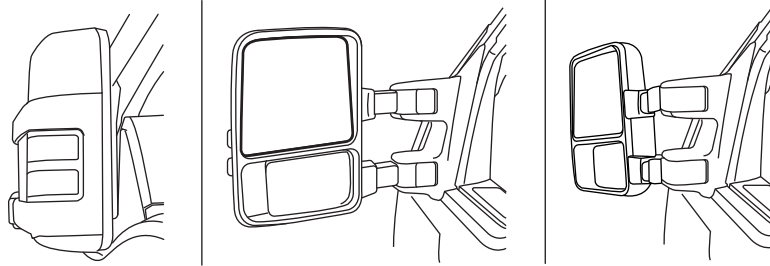

Powerfold mirror positions, from left to right: Position 1, Position 2, Position 3

The powerfold mirrors may be folded forward/rearward manually to any of the three positions shown and electrically to positions 1 and 2 only. If a mirror is folded manually forward to position 3, you must manually fold it back to position 1 or 2 in order for the powerfold function to continue functioning. **Note:** Although it is possible to electrically fold the mirror from position 3 to 2, it was not designed for this functionality and may not always work under all conditions.

Note: Ten or more switch activations within one minute, or repeated fold/unfolding of the mirrors while holding the switch rearward during the full travel may cause the system to disable the fold/unfold function to protect the motors from overheating. Should this occur, wait approximately 3½ minutes for the system to reset and function to return to normal.

Note: The powerfold mirrors are designed to operate while the vehicle is stationary or traveling at moderate speeds. If you attempt to powerfold the mirrors at high speeds, they may not fully fold forward/rearward - slow down and powerfold or manually fold the mirrors in order to complete the fold operation.

Note: If the power fold/telescope mirror glass appears loose or vibrates when driving, it is possible that the mirrors have been manually folded or telescoped. To minimize the vibration, ensure that the mirrors are electronically folded and telescoped in/out with the switches on the door trim panel. If the power fold mirrors are out of sync, electronically powerfold the mirrors to re-sync the motors. This will cause a loud “click” and the mirrors will jerk during re-synchronization. This is normal.

106

Driver Controls

Telescoping mirrors (if equipped)

The telescoping feature allows the mirror to extend approximately 2.75 inches (70 mm). This feature is especially useful to the driver when towing a trailer. Mirrors can be manually pulled out or pushed in to the desired telescopic position.

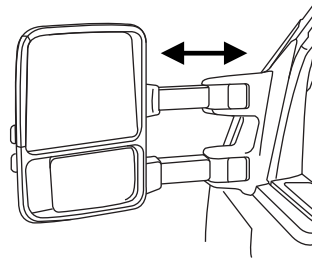

If equipped with power telescoping mirrors, you can simultaneously position both mirrors using the power telescope switch found on the door trim panel.

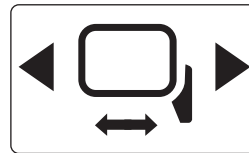

- To telescope the mirrors outboard, press and hold the left side of the power telescope switch until the mirrors reach their desired position. When the end of travel is reached, it is normal to hear the power telescoping motors running as long as you continue to hold the switch.
- To telescope the mirrors inboard, press and hold the right side of the power telescope switch until the mirrors reach their desired position.

Memory mirrors (if equipped)

This system allows automatic positioning of the outside rearview mirrors. For more information on this feature, refer to *Memory seats/power mirrors/adjustable pedals* in the *Seating and Safety Restraints* chapter.

Driver Controls

Mirror-mounted side turn signal indicator (if equipped)

When the vehicle turn signals are activated, the outer portion of the mirror housing will blink amber.

The turn signal feature can be seen by other drivers who may approach from the rear of the vehicle.

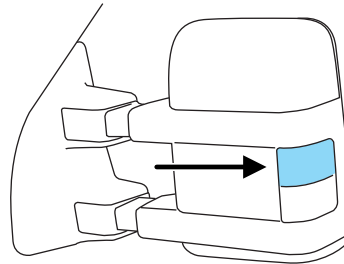

Clearance lamps (if equipped)

Illuminates when the headlamps or parking lamps are switched on.

This provides additional visibility of your vehicle to other drivers on the road.

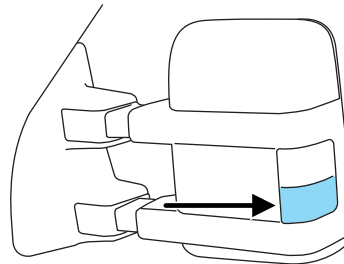

POWER ADJUSTABLE FOOT PEDALS (IF EQUIPPED)

The accelerator and brake pedal should only be adjusted when the vehicle is stopped and the gearshift lever is in the P (Park) position.

The control is located on the left side of the steering column. Press and hold the rear of the control to move the pedals toward you. Press and hold the front of the control to move the pedals away from you.

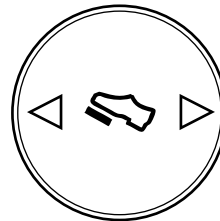

WARNING: Never adjust the accelerator and brake pedal with feet on the pedals while the vehicle is moving.

Driver Controls

The accelerator and brake pedal positions are saved when doing a memory set function and can be recalled along with the vehicle personality features when a memory position is selected. Refer to *Memory seats/power mirrors/adjustable pedals* in the *Seating and Safety Restraints* chapter.

SPEED CONTROL (IF EQUIPPED)

With speed control set, you can maintain a set speed without keeping your foot on the accelerator pedal.



WARNING: Do not use the speed control in heavy traffic or on roads that are winding, slippery or unpaved.

Using speed control

The speed controls are located on the steering wheel.

CNCL (Cancel)/RSM (Resume):

Press to cancel or resume a set speed.

ON/OFF: Press to turn the system on or off.

– **SET +:** Press to set a speed or to decrease or increase a set speed.

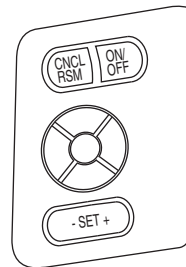

The speed control system uses two  indicator lights in the instrument cluster:

- an amber indicator light which illuminates when the system is on, and
- a green indicator light which illuminates when the system is engaged.

Setting speed control

To set speed control:

1. Press and release ON.
2. Accelerate to the desired speed.
3. Press and release SET +.
4. Take your foot off the accelerator pedal.
5. The green indicator light  on the instrument cluster will turn on.

Driver Controls

Note:

- Vehicle speed may vary momentarily when driving up and down a steep hill.
- If the vehicle speed increases above the set speed on a downhill, you may want to apply the brakes to reduce the speed.
- If the vehicle speed decreases more than 10 mph (16 km/h) below your set speed on an uphill, your speed control will disengage.

Disengaging a set speed

To disengage speed control, tap the brake pedal or press and release CNCL.

Disengaging the speed control will not erase the previous set speed.

Resuming a set speed

Press and release RSM. This will automatically return the vehicle to the previously set speed.

Increasing speed while using speed control

To increase the set speed:

- Press and hold SET + until you get to the desired speed, then release. You can also use SET + to operate the tap-up function. Press and release SET + to increase the vehicle set speed in 1 mph (1.6 km/h) increments.
- Use the accelerator pedal to get to the desired speed then press and release SET +.

Reducing speed while using speed control

To reduce a set speed:

- Press and hold SET – until you get to the desired speed, then release. You can also use SET – to operate the tap-down function. Press and release SET – to decrease the vehicle set speed in 1 mph (1.6 km/h) increments.
- Press the brake pedal until the desired vehicle speed is reached then press and release SET +.

Turning off speed control

To turn off the speed control, press OFF or turn off the ignition.

Note: When you turn off the speed control or the ignition, your speed control set speed memory is erased.

110

Driver Controls

STEERING WHEEL CONTROLS (IF EQUIPPED)

Audio control features

MEDIA: Press repeatedly to scroll through available audio modes.

◀◀ SEEK ▶▶: Press to select the previous/next radio station preset or CD track (if equipped). Press and hold to select the previous/next radio station frequency or to reverse/forward a CD.

+ VOL - (Volume): Press to increase or decrease the volume.

Navigation system hands free control features (if equipped)



Press and hold VOICE briefly until the voice  icon appears on the navigation display to use the voice command feature.

Press VOICE to complete a voice command.

For further information on the Navigation system, refer to the *Navigation System* supplement.

SYNC® system hands free control feature (if equipped)

Press VOICE briefly until the voice  icon appears on the display to use the voice command feature. You will hear a tone and LISTENING will appear in the radio display. Press and hold VOICE to exit voice command.

Press  to activate phone mode or answer a phone call. Press and hold  to end call or exit phone mode.

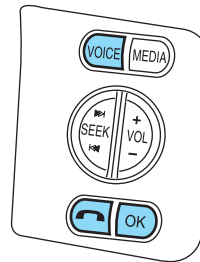
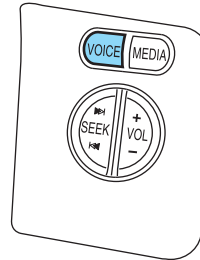
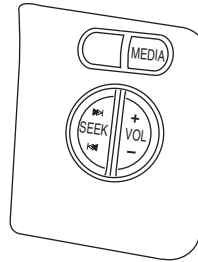



Driver Controls

Press **◀◀ ▶▶** to scroll through various menus and selections. Press OK to confirm your selection.

For further information on the SYNC® system, refer to the *SYNC®* supplement.

Navigation system/SYNC® hands free control features (if equipped)

Press VOICE briefly until the voice  icon appears on the navigation display to use the voice command feature.

Press  to activate phone mode or answer a phone call. Press and hold  to exit phone mode or end call.

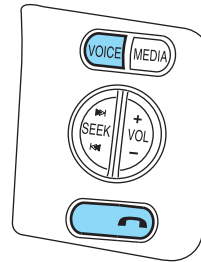

For further information on the Navigation system/SYNC® system, refer to the *Navigation System* and *SYNC®* supplements.

UPFITTER CONTROLS (IF EQUIPPED)

Your vehicle may be equipped with the Upfitter option package which will provide four switches, mounted in the center of the instrument panel, labeled AUX 1, AUX 2, AUX 3 and AUX 4. These switches will only operate while the ignition is in the on position, whether the engine is running or not. It is, however, recommended that the engine remain running to maintain battery charge when using the Upfitter switches for extended duration or higher current draws. (This is even more important for vehicles with diesel engines since the glow plugs are also draining battery power when the ignition key is in the on position.)

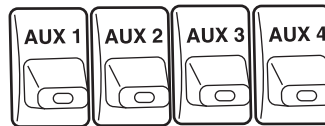

When switched on by the operator they provide 8 amps, 12 amps or 20 amps of electrical battery power for a variety of personal or commercial uses.

Driver Controls

If your vehicle is equipped with this option, there will also be a relay box located on the driver side end of the instrument panel. See your authorized dealer for service.

The relays are coded as shown in the accompanying illustration.

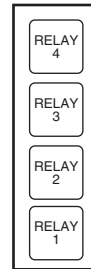

There will also be one power lead for each switch found as a blunt-cut and sealed wire located below the instrument panel and to the left of the steering column.

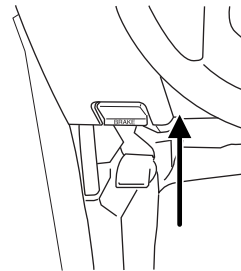

They are coded as follows:

Switch	Circuit number	Wire color	Fuse
AUX 1	CAC05	Yellow	25A
AUX 2	CAC06	Green with Brown Trace	25A
AUX 3	CAC07	Violet with Green Trace	10A
AUX 4	CAC08	Brown	15A

More detailed information about Upfitter switches can be found at <https://www.fleet.ford.com/truckbbas/>.

Driver Controls

MOON ROOF (IF EQUIPPED)

The moon roof control is located on the overhead console.



WARNING: Do not let children play with the moon roof or leave children unattended in the vehicle. They may seriously hurt themselves.



WARNING: When closing the moon roof, you should verify that it is free of obstructions and ensure that children and/or pets are not in the proximity of the moon roof opening.

The moon roof is equipped with an automatic, one-touch, express opening and closing feature. To stop motion at any time during the one-touch operation, press the control a second time.

To open the moon roof: Press and release the SLIDE control, the moon roof will open automatically. Press the switch again to stop the moon roof.

To close the moon roof: Pull and release the SLIDE control, the moon roof will close automatically. Press the switch again to stop the moon roof.

Bounce-back: When an obstacle has been detected in the moon roof opening as the moon roof is closing, the moon roof will automatically open and stop at a prescribed position.

Bounce-back override: To override bounce-back function, pull and hold the SLIDE switch within two seconds of a bounce-back event. The closing force will begin to increase each time the moon roof is closed for the first three closing cycles, with bounce-back active. For example: Bounce-back can be used to overcome the resistance of ice on the moon roof or seals

To vent the moon roof: Press and release the TILT control, the moon roof will move to the vent position automatically from any moon roof position. Press the switch again to stop the moon roof. Pull and hold the TILT control to close the moon roof.

The moon roof has a built-in sliding shade that can be manually opened or closed when the glass panel is shut. To close the shade, pull it toward the front of the vehicle.

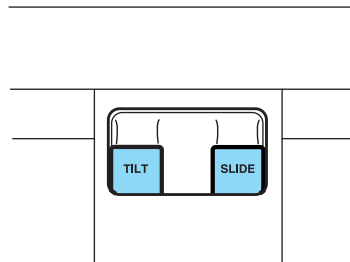

Driver Controls

UNIVERSAL GARAGE DOOR OPENER (IF EQUIPPED)

Your vehicle may be equipped with a universal garage door opener which can be used to replace the common hand-held transmitter.

Car2U® Home Automation System (if equipped)

The Car2U® Home Automation System is a universal transmitter located in the driver's visor that includes two primary features – a garage door opener and a platform for remote activation of devices within the home. The Car2U® system's garage door opener function replaces the common

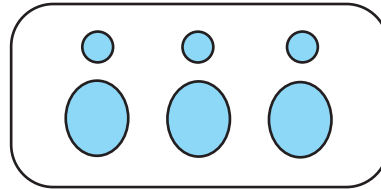

hand-held garage door opener with a three-button transmitter that is integrated into the interior of your vehicle. After being programmed for garage doors, the Car2U® system transmitter can be programmed to operate security devices and home lighting systems.



WARNING: Make sure that people and objects are clear of the garage door or security device you are programming. Do not program the Car2U® system with the vehicle in the garage.

Do not use the Car2U® system with any garage door opener that lacks safety stop and reverse features as required by U.S. Federal Safety Standards (this includes any garage door opener manufactured before April 1, 1982).

Be sure to keep the original remote control transmitter for use in other vehicles as well as for future Car2U® system programming. It is also recommended that upon the sale or lease termination of the vehicle, the programmed Car2U® system buttons should be erased for security reasons. Refer to *Erasing the Car2U® Home Automation System buttons* later in this section.

Read the instructions completely before attempting to program the Car2U® system. Because of the steps involved, it may be helpful to have another person assist you in programming the transmitter.

Additional Car2U® system information can be found on-line at www.learcar2U.com or by calling the toll-free Car2U® system help line at 1-866-572-2728.

Driver Controls

Types of garage door openers (rolling code and fixed code)

The Car2U® Home Automation System may be programmed to operate rolling code and fixed code garage door openers.

- Rolling code garage door openers were produced after 1996 and are code protected. Rolling code means the coded signal is changed every time your remote control garage door opener is used.
- Fixed code garage door openers were produced prior to 1996. Fixed code uses the same coded signal every time. It is manually programmed by setting DIP switches for a unique personal code.

If you do not know if your garage door opener is a rolling code or fixed code device, open your garage door opener's remote control battery cover. If a panel of DIP switches is present your garage door opener is a fixed code device. If not, your garage door opener is a rolling code device.

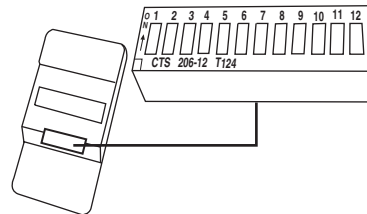

Rolling code programming

Note: Programming the rolling code garage door opener involves time-sensitive actions. Read the entire procedure prior to beginning so you will know which actions are time-sensitive. If you do not follow the time-sensitive actions, the device will time out and you will have to repeat the procedure.

Note: Do not program the Car2U® system with the vehicle in the garage. Make sure that your key is on and engine off while programming the transmitter.

Driver Controls

1. Firmly press the two outer Car2U® system buttons for 1–2 seconds, then release.

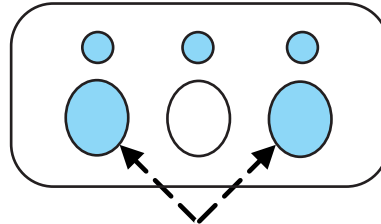

2. Go to the garage to locate the garage door opener motor and its “learn” button. You may need a ladder to reach the unit and you may need to remove the unit’s cover or light lens to locate the “learn” button. Press the “learn” button, after which you will have 10–30 seconds to return to your vehicle and complete the following steps. If you cannot locate the “learn” button, refer to the Owner’s Guide of your garage door opener or call the toll-free Car2U® system help line at 1-866-57Car2U (1-866-572-2728).

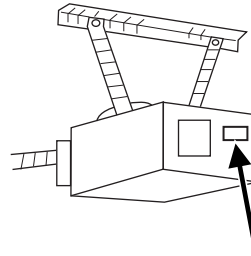

3. Return to your vehicle. Press and hold the Car2U® system button you would like to use to control the garage door. You may need to hold the button from 5–20 seconds, during which time the selected button indicator light will blink slowly. Immediately (within 1 second) release the button once the garage door moves. When the button is released, the indicator light will begin to blink rapidly until programming is complete.

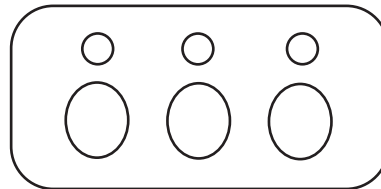

4. Press and release the button again. The garage door should move, confirming that programming is successful. If your garage door does not operate, repeat the previous steps in this section.

After successful programming, you will be able to operate your Car2U® system by pressing the button you programmed to activate the opener. The indicator light above the selected button will turn on to confirm that the Car2U® system is responding to the button command.

Driver Controls

To program another rolling code device such as an additional garage door opener, a security device or home lighting, repeat Steps 1 through 4 substituting a different function button in Step 3 than what you used for the garage door opener. For example, you could assign the left-most button to the garage door, the center button to a security device, and the right-most button to another garage door opener.

Note: The Car2U® system allows for three devices to be programmed. If you need to change or replace any of the three devices after it has been initially programmed, it is necessary to erase the current settings using the *Erasing the Car2U® Home Automation System buttons* procedure and then programming all of the devices being used.

Fixed code programming

Note: Do not program the Car2U® system with the vehicle in the garage. Make sure that your key is on and engine off while programming the transmitter.

1. To program units with fixed code DIP switches, you will need the garage door hand-held transmitter, paper and a pen or pencil.
2. Open the battery cover and record the switch settings from left to right for all 8 to 12 switches. Use the figure below:

When a switch is in the up, on, or + position, circle “L.”

When a switch is in the middle, neutral, or 0 position, circle “M.”

When a switch is in the down, off, or – position, circle “R.”

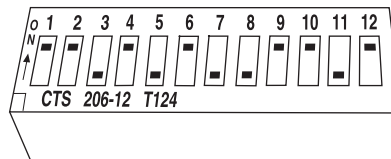

Switch position	1	2	3	4	5	6	7	8	9	10	11	12
Up, on or +	L	L	L	L	L	L	L	L	L	L	L	L
Middle, neutral or 0	M	M	M	M	M	M	M	M	M	M	M	M
Down, off or –	R	R	R	R	R	R	R	R	R	R	R	R

L=left; M=middle; R=right

Driver Controls

3. To input these positions into the Car2U® system, simultaneously press all three Car2U® system buttons for a few seconds and then release to put the device into programming mode. The indicator lights will blink slowly. Within 2.5 minutes enter your corresponding DIP switch settings from left to right into your Car2U® system by pressing and releasing the buttons corresponding to the settings you circled.

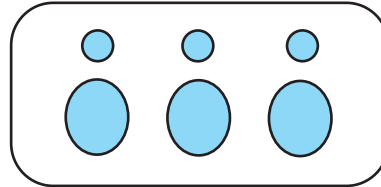

4. After inputting switch settings, simultaneously press and release all three Car2U® system buttons. The indicator lights will turn on.

5. Press and hold the Car2U® system button you would like to use to control the garage door. Immediately (within 1 second) release the button once the garage door moves. During this time the selected button indicator light will blink slowly. Do not release the button until you see the garage door move. Most garage doors open quickly. You may need to hold the button from 5–55 seconds before observing movement of the garage door.

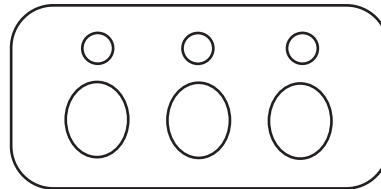

6. The indicator light will (begin to) blink rapidly until programming is complete. If your garage door opener does not operate following these steps, repeat Steps 2 through 6. Otherwise, call the toll-free Car2U® help line at 1-866-57Car2U (1-866-572-2728).

After successful programming, you will be able to operate your Car2U® system by pressing the button you programmed to activate the opener. The indicator light above the selected button will turn on to confirm that the Car2U® system is responding to the button command.

Erasing the Car2U® Home Automation System buttons

Note: The system allows for three devices to be programmed. If you need to change or replace any of the three devices after it has been initially programmed, it will be necessary to erase the current settings using the procedure below and then reprogramming all of the devices being used.

Driver Controls

To erase programming on the Car2U® system (individual buttons cannot be erased), use the following procedure:

1. Firmly press the two outside Car2U® system buttons simultaneously for approximately 20 seconds until the indicator lights begin to blink rapidly. The indicator lights are located directly above the buttons.

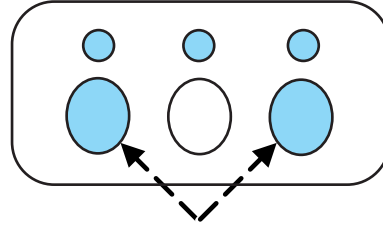

2. Once the indicator lights begin to blink, release your fingers from the buttons. The codes for all buttons are erased.

If you sell your vehicle equipped with the Car2U® system, it is recommended that you erase the programming for security reasons.

FCC and RSS-210 Industry Canada Compliance

The Car2U® system complies with Part 15 of the FCC rules and with RSS-210 of Industry Canada. Operation is subject to the following two conditions: (1) This device may not cause harmful interference, and (2) This device must accept any interference received including interference that may cause undesired operation.

Changes and modifications to the Car2U® system transmitter by other than an authorized service facility could void authorization to use the equipment.

POSITIVE RETENTION FLOOR MAT (IF EQUIPPED)



WARNING: Do not install additional floor mats on top of the factory installed floor mats as they may interfere with the accelerator or the brake pedals.

Position the floor mat so that the eyelet is over the retention post and press down to lock in. Make sure that the mat does not interfere with the operation of the accelerator or the brake pedal. To remove the floor mat, reverse the installation procedure.

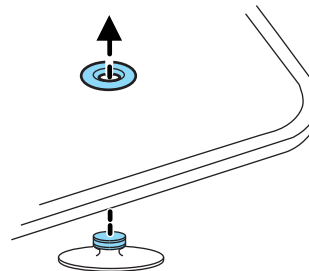

Driver Controls

TAILGATE LOCK (IF EQUIPPED)

Your vehicle may be equipped with a tailgate lock designed to help prevent theft of the tailgate.

- Insert ignition key and turn to the right to engage lock.
- Turn ignition key to the left to unlock.

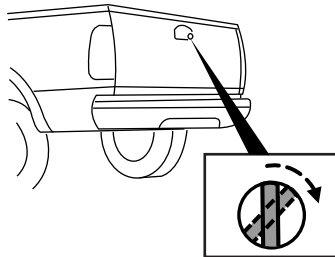

Tailgate removal

Your tailgate is removable to allow more room for loading.



WARNING: Always properly secure cargo to prevent shifting cargo or cargo falling from vehicle, which could result in compromised vehicle stability and serious personal injury to vehicle occupants or others.

Note: If equipped with a rearview camera system, do Steps 1 through 3 before removing the tailgate.

1. Before removal of the tailgate, locate and disconnect the tailgate in-line connector under the pickup box on the passenger side of the vehicle near the spare tire.
2. Install a protective cap (located in the glove box) onto the in-line rearview camera system connector that remains under the pickup box.
3. Partially lower tailgate and carefully feed tailgate harness up through the gap between the pickup box and the bumper. Place the tailgate harness out of the way under the pickup box.

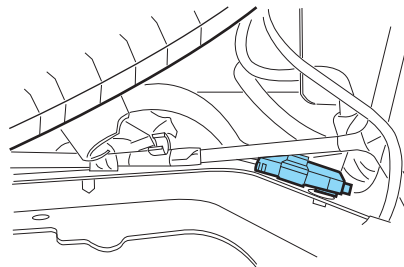

Driver Controls

4. Lower the tailgate.
 5. Using a screwdriver, gently pry the spring clip (on each connector) past the head of the support screw. Disconnect cable.
 6. Disconnect the other cable.
 7. Lift tailgate to a 45-degree angle from horizontal.
 8. Lift right side off of its hinge.
 9. Lift tailgate to a 80-degree angle from horizontal.
 10. Remove tailgate from left side hinge by sliding tailgate to the right.
- To install, follow the removal procedures in reverse order.

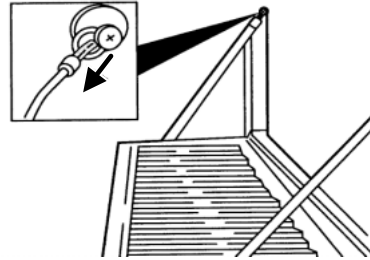

Tailgate step (if equipped)

Your vehicle may be equipped with a feature that allows easier entry into the truck bed. To open the tailgate step:

1. Flip down the tailgate.
2. Pull the yellow latch lever to the unlock position (🔓) to release the grab handle from its stowed position and raise the handle upright until you feel it latch and see the latch lever in the lock position (🔒). The yellow lever only needs to be used when releasing the grab handle.
3. Rotate the center molding to unlatch the tailgate step and pull it towards you to extend it.
4. Flip open the step panel to widen the step.

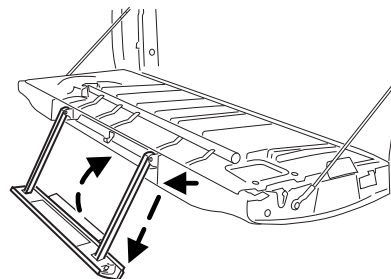
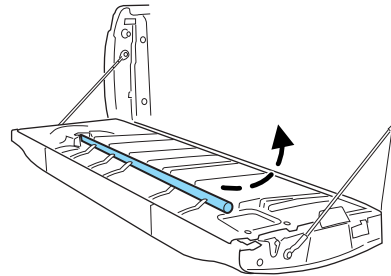

Note: To reduce risk of falling:

- Operate step only when the vehicle is on level surface.
- Operate step only in areas with sufficient lighting
- Always open flip panel to widen step.

122

Driver Controls

- Always use grab handle when stepping up and down.
- Step not intended for bare-footed use.
- Keep step clean from contamination before use (e.g. snow, mud)
- Keep the step load (you + load) below 350 lb (159 kg).
- Never drive with step deployed.

To close the tailgate step:

1. Close the step panel, then lift and fully close the tailgate step into the tailgate.
2. Slide the latch at the bottom of the handle, then lower the handle.

Note:

- Fully close and latch the tailgate step before moving the vehicle.
- Never drive with the step or grab handle deployed.
- Replace slip resistance tape (serviceable item) if worn out.
- Replace handle molding (serviceable item) if damaged.
- Do not tow with grab handle or step frame.

Bed extender (if equipped)

Your vehicle may be equipped with a cargo management feature in the truck bed.

Note: This feature is not intended for off-road usage.

To open the bed extender into tailgate mode:

1. Pull the locking pin toward the center of the vehicle.

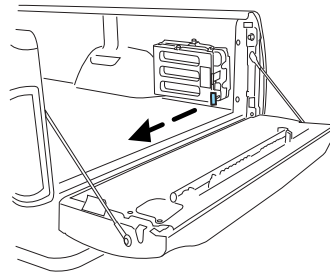

Driver Controls

2. Open the latches to release the panels.

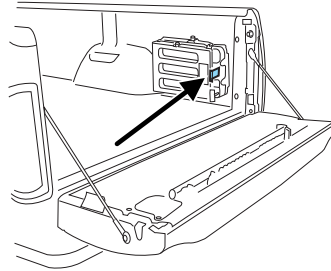

3. Rotate the panels toward the tailgate.

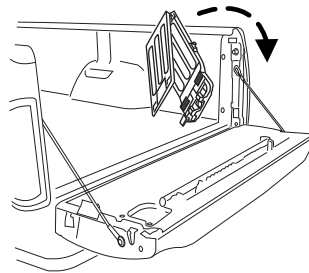

Repeat Steps 1–3 for the other side of the bed extender.

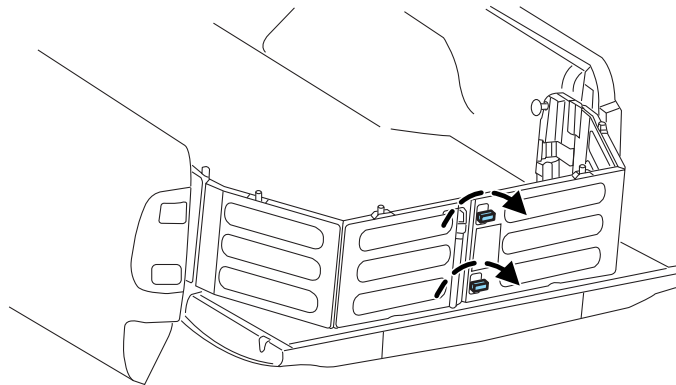

4. Connect the two panels, then rotate both knobs a quarter-turn clockwise to secure the panels.

124

Driver Controls

5. Ensure the latch rod is inserted into the tailgate hole and the locking pins on both sides are engaged into their holes in the pick-up box.

6. Reverse steps for storage of the bed extender.

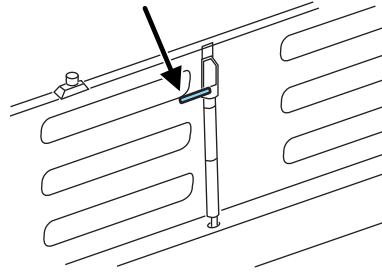

Note: When the vehicle is in motion, ensure the locking pins and knobs are fully engaged.

Note: Ensure all cargo is secured.

Note: When the vehicle is in motion, the tailgate load must not exceed 150 lb (68 kg).

Note: The bed extender should always be kept in the grocery mode or stowed position with the tailgate closed when not being used for the purpose of restraining cargo in the tailgate mode.

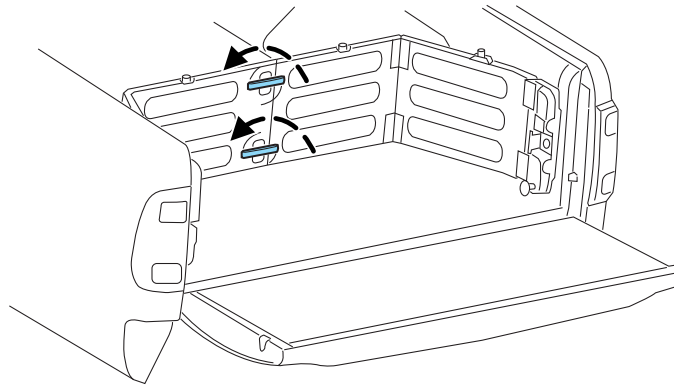

To open the bed extender into grocery mode, follow Steps 1–4 by rotating the panels away from the tailgate. Close the tailgate.

Locks and Security

KEYS

Your vehicle may be equipped with two integrated keyhead transmitters (IKTs). The key blade functions as a programmed key which starts the vehicle and unlocks/locks all the doors. The transmitter portion functions as the remote entry transmitter.

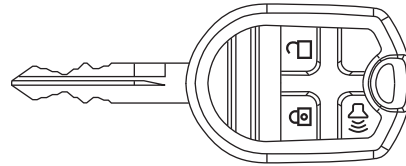

Your IKTs are programmed to your vehicle; using a non-programmed key will not permit your vehicle to start. If you lose one or both of your original programmed IKTs, replacement IKTs are available through your authorized dealer. Standard SecuriLock® keys without remote entry transmitter functionality can also be purchased from your authorized dealer if desired.

Always carry a spare key with you in case of an emergency.

For more information regarding programming replacement IKTs, refer to the *SecuriLock® passive anti-theft system* section later in this chapter.

Note: Your vehicle's IKTs were issued with a security tag that provides important vehicle key cut information. It is recommended that you keep the tag in a safe place for future reference.



MYKEY™

The MyKey™ feature allows you to program a restricted driving mode to promote good driving habits. All but one of the keys programmed to the vehicle can be activated as a MyKey™. The key will remain restricted until MyKey™ is disabled. Any remaining keys are referred to as an “administrator key” or admin key. The admin key can be used to create a MyKey™, program optional MyKey™ settings, and disable the MyKey™ feature. When the MyKey™ feature is enabled the user can use the system check in the message center to see how many MyKeys™ and admin keys are programmed to the vehicle, and how many total miles have been driven with the MyKey™ active.

Locks and Security

MyKey™ restricted features

Standard settings – These settings cannot be changed

- The audio system will be muted whenever Belt-Minder® is activated until the safety belts are buckled. Refer to the *Seating and Safety Restraints* chapter for a detailed description of Belt-Minder® operation.
- Low fuel warnings are displayed in the message center followed by a chime when the vehicle has only 1/8 tank of fuel.
- If equipped, any of the following: parking aid, Blind Spot Information System (BLIS™) with cross traffic alert and forward collision warning systems cannot be turned off.

Optional settings – These settings can be changed

- Vehicle speed is limited to 80 mph (130 km/h). Visual warnings are displayed followed by a chime when the vehicle speed has reached 80 mph (130 km/h).
- Visual warnings are displayed followed by a chime when a preselected vehicle speed of 45, 55 or 65 mph (75, 90, or 105 km/h) is exceeded
- The maximum volume of the audio system is limited to 45%. MYKEY VOLUME LIMITED will be displayed in the radio or navigation screen (if equipped) when attempting to exceed the limited volume
- The AdvanceTrac® system cannot be turned off. When this optional setting is on, the MyKey™ user will not be able to deactivate the system. **Note:** It may be beneficial to deactivate the AdvanceTrac® system if the vehicle is stuck in snow, mud, or sand.

Create a MyKey™

To program MyKey™ on one of the keys programmed to the vehicle, insert the key that you want to make a MyKey™ into the ignition. (For vehicles equipped with push button start, put the intelligent access key in the backup slot with the buttons facing out of the slot; see the *Driving* chapter for the location of the backup slot.) Turn the ignition on. Use the message center buttons to do the following:

For standard message center

1. Press SETUP until PRESS RESET TO CREATE MYKEY is displayed.
2. Press and release the RESET button. HOLD RESET TO CONFIRM MYKEY will be displayed.
3. Press and hold the RESET button for two seconds until MARK THIS AS RESTRICTED is displayed.
4. Wait until KEY RESTRICTED AT NEXT START is displayed.

Locks and Security

For optional message center

1. At the main menu screen select SETTING then MYKEY by pressing OK or the right arrow key.
2. Press OK to select CREATE MYKEY.
3. Hold OK as prompted until you see MARK THIS KEY AS RESTRICTED.

MyKey™ is successfully programmed. Make sure you label it so you can distinguish it from the admin keys. **Note:** To program the optional settings go to Step 2 in the *Programming MyKey™ Optional Settings* section. If your vehicle is equipped with remote start, see the *Using MyKey™ with remote start systems* section.

Note: The MyKey™ can be cleared within the same key cycle that it was created, otherwise a standard key (Administrator key) is required to disable the MyKey™ programming. To clear all MyKeys™ go to Step 2 in the *Disable MyKey™* section.

Programming MyKey™ optional settings

To program the optional settings, use the message center buttons to do the following:

For standard message center

1. Press SETUP until RESET FOR MYKEY SETTINGS is displayed.
2. Press and release the RESET button to display MyKey™ setup menus. The first menu shown is:

MYKEY MAX MPH <80 MPH> OFF

3. If you don't want to change the maximum speed setting, press the SETUP button to display the next menu. The remaining menus appear as follows with the default settings shown:

MYKEY MPH TONES 45 55 65 <OFF>

MYKEY VOLUME LIMIT <ON> OFF

MYKEY ADVTRAC CTRL ON <OFF>.

4. On any of the menus press RESET to highlight your choice with the <...>.
5. Press SETUP to enter your choice. The next optional setting will be displayed.
6. Repeat Steps 4 and 5 until you are done changing the optional settings.

For optional message center

1. At the main menu screen select SETTING then MYKEY by pressing OK or the right arrow key.

128

Locks and Security

2. Use the up and down arrows to get to any of the optional features.
3. Press the right arrow key to bring up the settings available for each feature.
4. Press OK or the right arrow key to make your choice.

Disable MyKey™

To reset all MyKeys™ as admin keys do the following:

For standard message center

1. Turn the vehicle on using the admin key.
2. Press SETUP until PRESS RESET TO CLEAR MYKEY is displayed.
3. Press and release the RESET button. HOLD RESET TO CONFIRM CLEAR is displayed.
4. Press and hold the RESET button for two seconds until ALL MYKEYS CLEARED is displayed.

For optional message center

1. At the main menu screen select SETTING then MYKEY by pressing OK or the right arrow key.
2. Press the down arrow key to get to CLEAR MYKEYS.
3. Hold OK until you see ALL MYKEYS CLEARED.

Check MyKey™ system status

The vehicle system check will provide the status of the following MyKey™ parameters:

- MYKEY MILES — This odometer only tracks distance when a MyKey™ is used. If mileage does not accumulate as expected, then the MyKey™ is not being used by the intended user. The only way to reset this odometer to zero is by disabling MyKey™. If this odometer is lower than the last time you checked, then the MyKey™ system has been recently cleared.
- # MYKEY(S) PROGRAMMED — Indicates how many MyKeys™ are programmed to the vehicle. Can be used to detect deletion of a MyKey™.
- # ADMIN KEYS PROGRAMMED — Indicates how many admin keys are programmed to the vehicle. Can be used to detect if an additional spare key has been programmed to the vehicle

Refer to *Message center* in the *Instrument Cluster* chapter for MyKey™ system warnings displays.

Locks and Security

Using MyKey™ with remote start systems

MyKey™ is not compatible with non Ford-approved aftermarket remote start systems. If you choose to install a remote start system please see your authorized dealer for a Ford approved remote start system.

The following information MAY help customers who choose to use a non Ford-approved remote start system. The actions proved below do not make MyKey™ compatible with non Ford-approved remote start system, but it MAY help you to retain some MyKey™ functions.

Vehicles equipped with traditional keys

When using a non Ford-approved remote start system, the default settings may recognize the remote start system as an additional admin key with its associated privileges. This makes it NOT compatible with MyKey™. The following action may help you to retain some MyKey™ functions:

1. Restart the engine when you insert a key into the ignition cylinder.
2. In addition to the key that you have already programmed as a MyKey™, owners of vehicles equipped with traditional keys may want to program the non Ford-approved remote start system as a MyKey™ if the remote start fob is used by the MyKey driver.

To program a non Ford-approved remote start system as MyKey™, do the following:

1. Enter the vehicle and close all doors.
2. Remote start the vehicle using a remote start fob.
3. Follow steps 1-4 in the *Create a MyKey™* section.

Vehicles equipped with intelligent access key (push button start)

- It is not possible to program any remote start system as MyKey™ on vehicles equipped with Intelligent Access Key (push button start). Therefore, you should treat the remote start fob as you would any other admin key. When the vehicle is started using remote start, the system will stall the engine when you either enter the vehicle or shift the vehicle into gear. Prior to the engine stall, the vehicle will have administrative privileges. When you restart the engine, the vehicle will identify the user as an admin or MyKey™ drive depending on the settings of the actual key used to start the vehicle.

Note: For all vehicles, the number of MYKEY(S) PROGRAMMED or ADMIN KEYS PROGRAMMED that is displayed in the MyKey™ System Status menus will include the non Ford-approved remote start system as an additional key in the total count. See the *Check MyKey™ System Status* section.

130

Locks and Security

Note: For all vehicles with a non Ford-approved remote start installed, it is possible to program all 'real' keys as MyKeys™, in which case, you will need to use your remote start system to reset all MyKeys™ as admin keys by doing the following:

1. Enter the vehicle, close all doors.
2. Remote start the vehicle using your remote start fob.
3. Follow steps 1-4 in the *Disable MyKey™* section.

Using MyKey™ with remote start systems

MyKey™ is not compatible with non Ford approved aftermarket remote start systems. If you choose to install a remote start system please see your authorized dealer for a Ford approved remote start system.

When using a Ford-approved remote start system, the default settings will recognize the remote start system as an additional admin key with its associated privileges. Owners of vehicles equipped with traditional keys should program the remote start system as a MyKey™ in addition to the key that they have already programmed as a MyKey™. To program the remote start system as MyKey™, do the following:

1. Enter the vehicle and close all doors.
2. Remote start the vehicle using a remote start fob.
3. Follow Steps 1-4 in the *Create a MyKey™* section.

Note: For all vehicles, the number of MYKEY(S) PROGRAMMED or ADMIN KEYS PROGRAMMED that is displayed in the MyKey™ system status menus will include the remote start system as an additional key in the total count. See the *Check MyKey™ system status* section.

Note: For all vehicles with remote start installed, it is possible to program all 'real' keys as MyKeys™, in which case, you will need to use your remote start system to reset all MyKeys™ as admin keys by doing the following:

1. Enter the vehicle, close all doors.
2. Remote start the vehicle using your remote start fob.
3. Follow Steps 1-4 in the *Disable MyKey™* section.

Locks and Security

Troubleshooting

Condition	Potential Causes
Can't create a MyKey™	<ul style="list-style-type: none"> • Key in the ignition is already a MyKey™. • Key in the ignition is the last remaining Admin key (there always has to be at least one Admin key). • SecuriLock® passive anti-theft system is disabled or in unlimited mode. • Vehicle has been started using a non Ford-approved remote start system that is programmed as MyKey™. Refer to <i>Using MyKey™ with remote start systems</i> section.
Cannot program the MyKey™ optional settings	<ul style="list-style-type: none"> • Key in the ignition is a MyKey™. • No MyKeys™ are programmed to the vehicle. Refer to <i>Create a MyKey™</i> section. • Vehicle has been started using a non Ford-approved remote start system that is programmed as MyKey™. Refer to <i>Using MyKey™ with remote start systems</i> section.
Cannot disable MyKey™	<ul style="list-style-type: none"> • Key in the ignition is a MyKey™ . • No MyKeys™ are programmed to the vehicle. Refer to <i>Create a MyKey™</i> section. • Vehicle has been started using a non Ford-approved remote start system that is programmed as MyKey™. Refer to <i>Using MyKey™ with remote start systems</i> section.
Lost the only Admin key	<ul style="list-style-type: none"> • Purchase a new key from your authorized dealer.
Lost any key	<ul style="list-style-type: none"> • For programming spare keys, refer to the <i>Programming spare keys</i> section in this chapter.

Locks and Security

Condition	Potential Causes
I accidentally programmed all keys as MyKeys™	<ul style="list-style-type: none"> • Vehicle has a non Ford-approved remote start system that is recognized as an Admin key. Refer to the <i>Using MyKey™ with remote start systems</i> section to reset all MyKeys™ as Admin keys.
No MyKey™ function with (if equipped) intelligent access key with push button start	<ul style="list-style-type: none"> • An Admin intelligent access key is present at a push-and-start vehicle. • No MyKeys™ are programmed to the vehicle. Refer to <i>Create a MyKey™</i> section. • Vehicle has been started using a non Ford-approved remote start system (as an Admin key) then a MyKey™ is inserted without restarting the engine.
MyKey™ programmed total includes one additional key	<ul style="list-style-type: none"> • Unknown key has been programmed to the vehicle as a MyKey™. • Vehicle is equipped with a non Ford-approved remote start system. Refer to <i>Using MyKey™ with remote start systems</i> section.
Admin keys programmed total includes one additional key	<ul style="list-style-type: none"> • Unknown key has been programmed to the vehicle as Admin key. • Vehicle is equipped with a non Ford-approved remote start system. Refer to <i>Using MyKey™ with remote start systems</i> section.
MyKey™ distance does not accumulate	<ul style="list-style-type: none"> • MyKey™ is not being used by the intended user. • MyKey™ system has been recently cleared. • Vehicles has been started using a non Ford-approved remote start system (as an Admin key) then a MyKey™ is inserted without recycling the MyKey™ in ignition.

Locks and Security

POWER DOOR LOCKS (IF EQUIPPED)

Press control to unlock all doors.

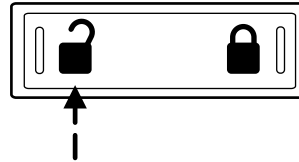

Press control to lock all doors.

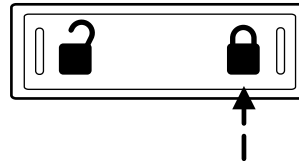

Smart locks (if equipped)

This feature prevents you from locking yourself out of the vehicle if your key is still in the ignition.

When you open the driver's door and you lock the vehicle with the power door lock control, all the doors will lock, then the driver's door will automatically unlock reminding you that your key is still in the ignition.

The vehicle can still be locked, with the key in the ignition, using the manual lock button on the door, locking the driver's door with a key, by simultaneously pressing button 7 • 8 and the 9 • 0 controls on the remote entry keypad (if equipped), or using the  button on the remote entry transmitter (if equipped).

Autolock feature (if equipped)

The autolock feature will lock all the doors when:

- all the doors are closed,
- the ignition is in the on position,
- you shift into any gear putting the vehicle in motion, and
- the vehicle attains a speed greater than 12 mph (20 km/h) for greater than two seconds.

Locks and Security

The autolock feature repeats when:

- any door is opened then closed while the ignition is in the on position and the vehicle speed is 9 mph (15 km/h) or lower, and
- the vehicle then attains a speed greater than 12 mph (20 km/h) for greater than two seconds.

Deactivating/activating autolock feature

There are four methods to enable/disable this feature:

- Through your authorized dealer,
- by using a power door unlock/lock procedure,
- using a keypad procedure (if equipped), or
- or by using the instrument cluster message center (if equipped). Refer to *Message center* in the *Instrument Cluster* chapter.

Note: The autolock feature can be activated/deactivated independently of the autounlock feature.

Power door lock switch autolock enable/disable procedure

Before starting, ensure the ignition is in the off position and all vehicle doors are closed. You must complete Steps 1–5 within 30 seconds or the procedure will have to be repeated. If the procedure needs to be repeated, wait a minimum of 30 seconds before beginning again.

1. Place the key in the ignition and turn the ignition to the on position.

2. Press the power door unlock control on the door panel three times.

3. Turn the ignition from the on position to the off position.

4. Press the power door unlock control on the door panel three times.

5. Turn the ignition back to the on position. The horn will chirp one time to confirm programming mode has been entered and is active.

6. To enable/disable the autolock feature, press the unlock control, then press the lock control. The horn will chirp once if autolock was deactivated or twice (one short and one long chirp) if autolock was activated.

7. Turn the ignition to the off position. The horn will chirp once to confirm the procedure is complete.

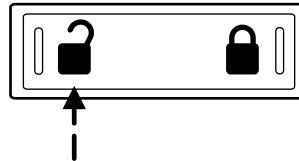

Locks and Security

Keyless entry keypad autolock enable/disable procedure

1. Turn the ignition to the off position.
2. Close all the doors.
3. Enter factory-set 5-digit entry code.
4. Press and hold the 3 • 4. While holding the 3 • 4 press the 7 • 8.
5. Release the 7 • 8.
6. Release the 3 • 4.

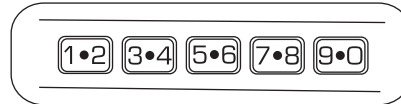

The user should receive a **horn chirp** to indicate the system has been disabled or a chirp followed by a honk to indicate the system has been enabled.

Autounlock feature (if equipped)

The autounlock feature will unlock all the doors when:

- the ignition is in the on position, all the doors are closed, and the vehicle has been in motion at a speed greater than 12 mph (20 km/h);
- the vehicle has then come to a stop and the ignition is turned to the off) or accessory position; and
- the driver door is opened within 10 minutes of the ignition being transitioned to the off or accessory position.

Note: The doors will not autounlock if the vehicle has been electronically locked before the driver door is opened.

Deactivating/activating autounlock feature

There are three methods to enable/disable this feature:

- Through your authorized dealer,
- by using a power door unlock/lock sequence,
- using a keypad procedure (if equipped)
- or by using the instrument cluster message center (if equipped). Refer to *Optional message center* in the *Driver controls* chapter.

Note: The autounlock feature can be activated/deactivated independently of the autolock feature.

Locks and Security

Power door lock switch autounlock enable/disable procedure

Before starting, ensure the ignition is in the off position and all vehicle doors are closed. You must complete Steps 1–5 within 30 seconds or the procedure will have to be repeated. If the procedure needs to be repeated, wait a minimum of 30 seconds before beginning again.

1. Place the key in the ignition and turn the ignition to the on position.

2. Press the power door unlock control on the door panel three times.

3. Turn the ignition from the on position to the off position.

4. Press the power door unlock control on the door panel three times.

5. Turn the ignition back to the on position. The horn will chirp one time to confirm programming mode has been entered and is active.

6. To enable/disable the autounlock feature, press the lock control, then press the unlock control. The horn will chirp once if autounlock was deactivated or twice (one short and one long chirp) if autounlock was activated.

7. Turn the ignition to the off position. The horn will chirp once to confirm the procedure is complete.

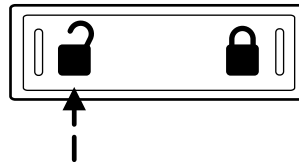

Keyless entry keypad autounlock enable/disable procedure

1. Turn the ignition to the off position.

2. Close all the doors.

3. Enter factory-set 5-digit entry code.

4. Press and hold the 3 • 4. While holding the 3 • 4, press and release the 7 • 8. While still holding the 3 • 4, press and release the 7 • 8 a second time.

5. Release the 3 • 4.

The user should receive a **horn chirp** to indicate the system has been disabled or a chirp followed by a honk to indicate the system has been enabled.

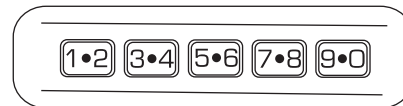

Locks and Security

CHILDPROOF DOOR LOCKS (IF EQUIPPED)

- When these locks are set, the rear doors cannot be opened from the inside.
- The rear doors can be opened from the outside when the childproof door locks are set, but the doors are unlocked.

The childproof locks are located on the rear edge of each rear door and must be set separately for each door. Setting the lock for one door will not automatically set the lock for both doors.

- Move lock control up to engage the childproof lock.
- Move lock control down to disengage the childproof lock.

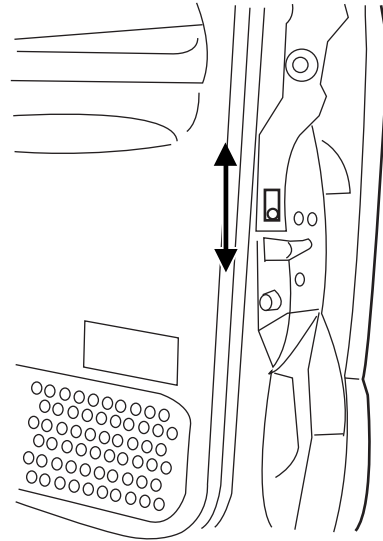

REMOTE ENTRY SYSTEM (IF EQUIPPED)

The integrated keyhead transmitter (IKT) complies with part 15 of the FCC rules and with RSS-210 of Industry Canada. Operation is subject to the following two conditions: (1) This device may not cause harmful interference, and (2) This device must accept any interference received, including interference that may cause undesired operation.

Changes or modifications not expressly approved by the party responsible for compliance could void the user's authority to operate the equipment.

There are two possible types of IKTs: vehicles with the remote start feature will have the IKT shown. Vehicle's without remote start will not have the remote start button (2x) .

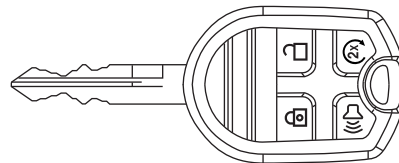

Locks and Security

The typical operating range for your IKT is approximately 33 feet (10 meters). A decrease in operating range could be caused by:

- weather conditions,
- nearby radio towers,
- structures around the vehicle, or
- other vehicles parked next to your vehicle.



The IKT allows you to:

- remotely unlock the vehicle doors.
- remotely lock all the vehicle doors.
- remotely start the engine (if equipped with remote start).
- activate the personal alarm.
- operate the illuminated entry feature.

The remote entry lock/unlock feature operates in any ignition position except while the key is held in the start position. The panic feature operates with the key in the off position.

If there are problems with the remote entry system, make sure to take **ALL integrated keyhead transmitters** with you to the authorized dealer in order to aid in troubleshooting the problem.

Two step door unlocking

1. Press  and release to unlock the driver's door. **Note:** The parking lamps and interior lamps will illuminate (refer to the *Illuminated entry* feature later in this section) if the control on the overhead lamp is **not** set to the **off** position.
2. Press  and release again within three seconds to unlock the passenger doors.



The battery saver feature will turn off the lamps 10 minutes after the ignition is turned to the off position.

One step door unlocking



If the one step door unlocking feature is activated, press  and release once to unlock all of the doors. **Note:** The parking lamps and interior lamps will illuminate (refer to the *Illuminated entry* feature later in this section) if the control on the overhead lamp is **not** set to the **off** position.

Locks and Security

Switching from two step to one step door unlocking

Your vehicle comes with two step unlocking enabled. Unlocking can be switched between two step and one step door unlocking by pressing and holding both the  and  buttons simultaneously on the remote entry transmitter for approximately four seconds. The hazard lamps will flash twice to indicate that the vehicle has switched to one step unlocking. Repeat the procedure to switch back to two-step unlocking.

Locking the doors

1. Press  and release to lock all the doors. The parking lamps will illuminate if all the doors are closed and locked.
2. Press  and release again within three seconds to confirm that all the doors are closed and locked. **Note:** The doors will lock again, the horn will chirp once, and the parking lamps will illuminate once more. If any of the doors are not properly closed the horn will make two quick chirps and the parking lamps will not flash.

Car finder

Press  twice within three seconds. The horn will chirp and the turn lamps will flash. It is recommended that this method be used to locate your vehicle, rather than using the panic alarm.

Sounding a panic alarm

Press  to activate the alarm. Press again or turn the ignition to on to deactivate.

Note: The panic alarm will only operate when the ignition is in the off position.

Memory feature (seat, mirrors and adjustable pedals)

The Integrated Keyhead Transmitter (IKT) allows you to recall the memory seat/power mirrors/adjustable pedals feature.

Press  to automatically move the driver seat, power mirrors and adjustable pedals to the desired memory position. (The seat position corresponds to the transmitter being used).

Programming memory feature to Transmitter

To activate this feature:

1. Move the driver seat, power mirrors, and adjustable pedals to the desired positions using the associated controls.

140

Locks and Security

2. Press and hold control button 1 for five seconds. A tone will be heard after two seconds confirming memory position has been set. Continue to hold until a second tone is heard after five seconds.

3. Within three seconds press the .

4. A tone will be heard when the transmitter programming is complete.

5. Press the .

6. Repeat this procedure for memory 2 and another transmitter if desired.

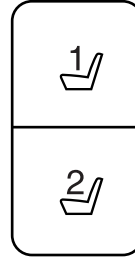

Deprogramming memory feature from Transmitter

To deactivate this feature:

1. Press and hold either the 1 or 2 control on the driver's door for five seconds. A tone will be heard after 1½ seconds when the memory store is done, continue to hold until a second tone is heard after five seconds.

2. Within three seconds press the .

3. A tone will be heard when the deactivation is complete.

4. Repeat this procedure for another transmitter if desired.

Replacing the battery

The integrated keyhead transmitter uses one coin type three-volt lithium battery CR2032 or equivalent.

To replace the battery:

1. Twist a thin coin in the slot of the IKT near the key ring in order to remove the battery cover.

Note: Do not wipe off any grease on the battery terminals on the back surface of the circuit board.

2. Remove the old battery.

Note: Please refer to local regulations when disposing of transmitter batteries.

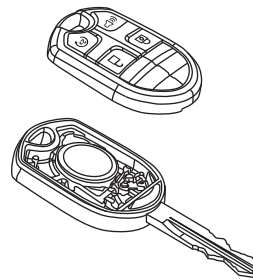

Locks and Security

3. Insert the new battery. Refer to the instructions inside the IKT for the correct orientation of the battery. Press the battery down to ensure that the battery is fully seated in the battery housing cavity.
4. Snap the battery cover back onto the key.

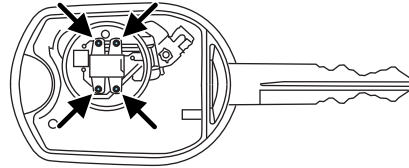

Note: Replacement of the battery will **not** cause the IKT to become deprogrammed from your vehicle. The IKT should operate normally after battery replacement.

Replacing lost Integrated Keyhead Transmitters (IKTs)

If you would like to have your Integrated Keyhead Transmitters reprogrammed because you lost one, or would like to buy additional IKTs, you can either reprogram them yourself, or take **all IKTs** to your authorized dealer for reprogramming.

How to reprogram your Integrated Keyhead Transmitters (IKTs)

To program a new Integrated Keyhead Transmitter yourself, refer to *Programming spare keys* in the *SecuriLock® passive anti-theft system* section of this chapter. **Note:** At least two IKTs are required to perform this procedure yourself.

Illuminated entry

The interior lamps and parking lamps illuminate when the remote entry system is used to unlock the door(s).

The illuminated entry system will turn off the lights if:

- the ignition switch is turned to the on position, or
- the remote transmitter lock control is pressed, or
- the 7 • 8 and the 9 • 0 controls on the keyless entry keypad are pressed, or
- after 25 seconds of illumination.

Locks and Security

The dome lamp control (if equipped) must **not** be set to the off position for the illuminated entry system to operate.

The lights will not turn off if:

- they have been turned on with the dimmer control, or
- any door is open.

The battery saver will shut off the interior lamps 30 minutes after the ignition has been turned to the off position, 10 minutes after if the dome lamp is off, and 30 minutes after if the dome lamp switch is left on.

Remote start (if equipped)

Your vehicle may be equipped with the remote start feature which allows you to start the engine from outside the vehicle. If your Integrated Keyhead Transmitter (IKT) has a  icon, you have remote start. The remote start feature has an extended operating range which allows you to remote start your vehicle from a farther distance from your vehicle. All the buttons have this increased range performance capability when equipped with remote start.

Many states and provinces have restrictions for the use of remote start. Check your local and state or provincial laws for specific requirements regarding remote start systems.

Note: Do not use remote start if your vehicle is low on fuel.



WARNING: To avoid exhaust fumes, do not use remote start if your vehicle is parked indoors or areas that are not well ventilated.

The remote start system will not work if:



- The ignition is in the on position.
- The alarm system is triggered.
- The feature has been disabled.
- The hood is not closed.
- Two remote vehicle starts have already been attempted within the last hour.
- The vehicle is not in P (Park).

Locks and Security

Starting the engine with remote start

To start the engine using remote start:

Note: Each button press must be done within 3 seconds of each other. If this sequence is not followed the vehicle will not remote start and the horn will not chirp.

1. Press  on the IKT to lock all the doors.
2. Press  two times. The exterior lamps will flash twice.

Note: On diesel engines there will be a 3 second delay before the engine starts.

If for some reason, the system fails to start, the horn will chirp twice.

3. Insert the key in the ignition and turn to the on position before driving.

The power windows will be inhibited during the remote start and the radio will not turn on.

The parking lamps will remain on and the engine will run for 5, 10, or 15 minutes, depending on how you programmed the system. To select the duration of the remote start system refer to *Message center* in the *Instrument Cluster* chapter.

Extending the engine run time

To keep the engine running for another remote start duration, repeat Steps 1 and 2 with the engine still running. If you programmed the duration to last 10 minutes, the second 10 minutes will begin immediately so that, for example, if the vehicle had been running from the first remote start for five minutes, the engine will continue to run for a total of 15 minutes. You can only extend the remote start once.

The ignition switch must be turned to the on position and then back to the off position or allow one hour to pass before using remote start again.

Turning the engine off after using remote start

- Press  one time. The parking lamps will turn off.

You may have to be closer to the vehicle than when starting due to ground reflection and the added noise of the running engine.

You can disable or enable the remote start system through the message center. Refer to *Message center* in the *Instrument Cluster* chapter.

Locks and Security

SECURICODE™ KEYLESS ENTRY SYSTEM (IF EQUIPPED)

You can use the keyless entry keypad to lock or unlock the doors without using a key.



The keypad can be operated with the factory set 5-digit entry code; this code is located on the owner's wallet card in the glove box, is marked on the computer module, and is available from your authorized dealer. You can also create your own 5-digit personal entry code.

When pressing the controls on the keypad, press the middle of the controls to ensure a good activation.

Programming a personal entry code and keypad association to memory seats, mirrors and pedals

To create your own personal entry code:

1. Enter the factory set code.
2. Within five seconds press the 1 • 2 on the keypad.
3. Enter your personal 5-digit code. Each number must be entered within five seconds of each other.
4. To associate the entry code with a memory setting, enter a sixth digit to indicate which driver should be set in a memory recalled by the personal entry code:
 - Pressing 1 • 2 recalls Driver 1 settings.
 - Pressing 3 • 4 recalls Driver 2 settings.
 - Pressing other keypad buttons or not pressing a keypad button as a sixth digit does not set a driver and will not recall a memory setting.**Note:** The factory-set code cannot be associated with a memory setting.
5. The doors will again lock then unlock to confirm that your personal keycode has been programmed to the module.

Tips:

- Do not set a code that uses five of the same number.
- Do not use five numbers in sequential order.
- The factory set code will work even if you have set your own personal code.

Erasing personal code

1. Enter the factory set 5-digit code.
2. Within five seconds, press the 1 • 2 on the keypad and release.

Locks and Security

3. Press and hold the 1 • 2 for two seconds. This must be done within five seconds of completing Step 2.

Your personal code is now erased and only the factory set 5-digit code will work.

Anti-scan feature

If an incorrect code has been entered seven times (35 consecutive button presses), the keypad will go into an anti-scan mode. This mode disables the keypad for one minute and the keypad lamp will flash during this time.

The anti-scan feature will turn off after:

- one minute of keypad inactivity.
- pressing the  control on the remote entry transmitter.
- the ignition is turned to the on position.

Unlocking and locking the doors using keyless entry

To unlock the driver's door, enter the factory set 5-digit code or your personal code. Each number must be pressed within five seconds of each other. The interior lamps will illuminate after entering a valid keypad entry code.

To unlock all doors, press the 3 • 4 control within five seconds.

To lock all doors, press the 7 • 8 and the 9 • 0 at the same time. You **do not** need to enter the keypad code first. **Note:** The interior lamps will turn off.

SECURILOCK® PASSIVE ANTI-THEFT SYSTEM (IF EQUIPPED)

SecuriLock® passive anti-theft system is an engine immobilization system. This system is designed to help prevent the engine from being started unless a **coded key programmed to your vehicle** is used. The use of the wrong type of coded key may lead to a “no-start” condition. The message center will display: **STARTING SYSTEM FAULT**.

Your vehicle comes with two coded keys; additional coded keys may be purchased from your authorized dealer. The authorized dealer can program your spare keys to your vehicle or you can program the keys yourself. Refer to *Programming spare keys* for instructions on how to program the coded key.

Note: The SecuriLock® passive anti-theft system is not compatible with non-Ford aftermarket remote start systems. Use of these systems may result in vehicle starting problems and a loss of security protection.

146

Locks and Security

Note: Large metallic objects, electronic devices that are used to purchase gasoline or similar items, or a second coded key on the same key chain may cause vehicle starting issues. You need to prevent these objects from touching the coded key while starting the engine. These objects will not cause damage to the coded key, but may cause a momentary issue if they are too close to the key when starting the engine. If a problem occurs, turn the ignition off, remove all objects on the key chain away from the coded key and restart the engine.

Note: Do not leave a duplicate coded key in the vehicle. Always take your keys and lock all doors when leaving the vehicle.

Automatic arming

The vehicle is armed immediately after switching the ignition to the off position.

Automatic disarming

Switching the ignition to the on position with a **coded key** disarms the vehicle.

Replacement keys

If your keys are lost or stolen and you don't have an extra coded key, you will need to have your vehicle towed to an authorized dealer. The key codes need to be erased from your vehicle and new coded keys will need to be programmed.

Replacing coded keys can be very costly. Store an extra programmed key away from the vehicle in a safe place to help prevent any inconveniences. Please visit an authorized dealer to purchase additional spare or replacement keys.

Programming spare keys

A maximum of eight keys can be coded to your vehicle. Only SecuriLock® keys can be used. To program a **coded key** yourself, you will need two previously programmed **coded keys** (keys that already operate your vehicle's engine) and the new unprogrammed key(s) readily accessible for timely implementation of each step in the procedure.

If two previously programmed coded keys are not available, you must bring your vehicle to your authorized dealer to have the spare coded key(s) programmed.

Please read and understand the entire procedure before you begin.

Locks and Security

1. Insert the first previously programmed **coded key** into the ignition and turn the ignition from the 1 (off) position to the 3 (on) position (maintain ignition in the 3 (on) position for at least one second, but no more than 10 seconds).

2. Turn ignition from the 3 (on) position back to the 1 (off) position in order to remove the first **coded key** from the ignition.

3. After three seconds but within 10 seconds of removing the first **coded key**, insert the second previously programmed **coded key** into the ignition and turn the ignition from the 1 (off) position to the 3 (on) position (maintain ignition in the 3 (on) position for at least one second but no more than 10 seconds).

4. Turn the ignition from the 3 (on) position back to the 1 (off) position in order to remove the second **coded key** from the ignition.

5. After three seconds but within 10 seconds of removing the second **coded key**, insert the new unprogrammed key (new key/valet key) into the ignition and turn the ignition from the 1 (off) position to the 3 (on) position (maintain ignition in the 3 (on) position for at least one second, but no more than 10 seconds). This step will program your new key to a coded key.

6. To program additional new unprogrammed key(s), repeat Steps 1 through 5.

If successful, the new coded key(s) will start the vehicle's engine and the theft indicator will illuminate for three seconds and then go out.

If not successful, the new coded key(s) will not start the vehicle's engine and the theft indicator will flash on and off and you may repeat Steps 1 through 5. If failure repeats, bring your vehicle to your authorized dealer to have the new spare key(s) programmed.

PERIMETER ALARM SYSTEM (IF EQUIPPED)

The perimeter anti-theft system will warn you in the event of an unauthorized entry to your vehicle.

If there is any potential perimeter anti-theft problem with your vehicle, ensure **ALL remote entry transmitters** are taken to the authorized dealer to aid in troubleshooting.

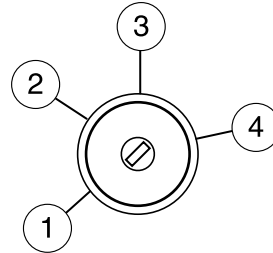

Locks and Security

Arming the system

When armed, this system will respond if unauthorized entry is attempted. When unauthorized entry occurs, the system will flash the park/turn lamps and will sound the horn.

The system is ready to arm whenever the key is removed from the ignition. Either of the following actions will prearm the alarm system:

- Press the  control on the remote entry transmitter.
- Open a door and press the power door lock control to lock all the doors, and then close the door.
- Press and hold the 7 • 8 and 9 • 0 controls on the keyless entry pad at the same time to lock the doors (driver's door must be closed).

There is a 20 second countdown when any of the above actions occur before the vehicle becomes armed.

Each door and the hood is armed individually, and if any are open, they must be closed before the open entry point can enter the 20 second countdown.

The turn signal lamps will flash once when all doors and the hood are closed indicating the vehicle is locked and entering the 20 second countdown.

Disarming the system

You can disarm the system by any of the following actions:

- Unlock the doors by pressing the  control on your remote entry transmitter.
- Turn the ignition to the on position with a programmed coded ignition key.
- Unlock the doors by using your keyless entry pad.
- If using a key in the driver's door to unlock the vehicle, a chime will sound when you open the door and you will have 12 seconds to disarm the alarm system using any of the actions above, otherwise the alarm will trigger.

Pressing the power door unlock control within the 20 second prearmed mode will return the vehicle to a disarmed state.

Triggering the anti-theft system

The armed system will be triggered if any door or hood is opened without using the key or the remote entry transmitter.

Seating and Safety Restraints

FRONT SEATING

 **WARNING:** Reclining the seatback can cause an occupant to slide under the seat's safety belt, resulting in severe personal injuries in the event of a collision.

 **WARNING:** Do not pile cargo higher than the seatbacks to reduce the risk of injury in a collision or sudden stop.

 **WARNING:** Before returning the seatback to its original position, make sure that cargo or any objects are not trapped behind the seatback. After returning the seatback to its original position, pull on the seatback to ensure that it has fully latched. An unlatched seat may become dangerous in the event of a sudden stop or collision.

Adjustable head restraints

Your vehicle is equipped with front row outboard head restraints that are vertically adjustable.

 **WARNING:** To minimize the risk of neck injury in the event of a crash, the driver and passenger occupants should not sit in and/or operate the vehicle, until the head restraint is placed in its proper position. The driver should never adjust the head restraint while the vehicle is in motion.

The adjustable head restraints consist of :

- a trimmed energy absorbing foam and structure (1),
- two steel stems (2),
- a guide sleeve adjust/release button (3),
- and a guide sleeve unlock/remove button (4).

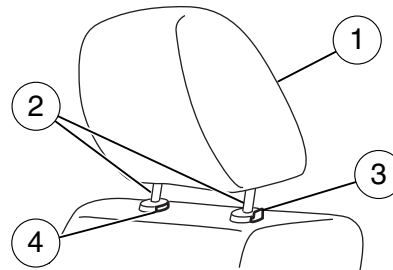

Seating and Safety Restraints

To adjust the head restraint, do the following:

1. Adjust the seatback to an upright driving/riding position.
2. Raise the head restraint by pulling up on the head restraint.

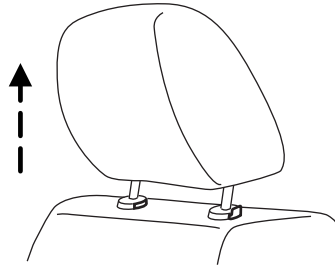

3. Lower the head restraint by pressing and holding the guide sleeve adjust/release button and pushing down on the head restraint.

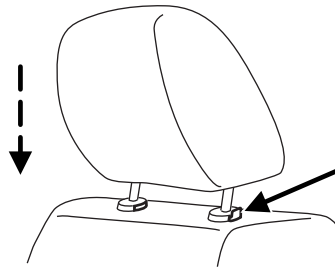

Properly adjust the head restraint so that the top of the head restraint is even with the top of your head and positioned as close as possible to the back of your head. For occupants of extremely tall stature, adjust the head restraint to its full up position.



WARNING: The adjustable head restraint is a safety device. Whenever possible it should be installed and properly adjusted when the seat is occupied.

Seating and Safety Restraints

To remove the adjustable head restraint, do the following:

1. Pull up the head restraint until it reaches the highest adjustment position.

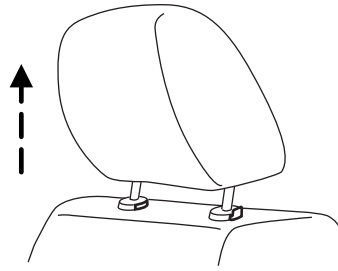

2. Simultaneously press and hold both the adjust/release button and the unlock/remove button, then pull up on the head restraint.

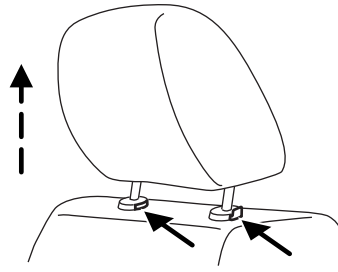

To reinstall the adjustable head restraint, do the following:

1. Insert the two stems into the guide sleeve collars.
2. Push the head restraint down until it locks.

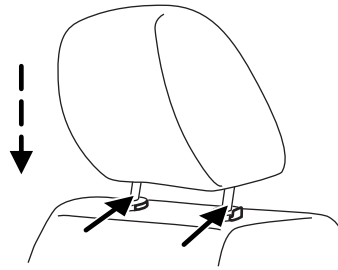

Seating and Safety Restraints

Properly adjust the head restraint so that the top of the head restraint is even with the top of your head and positioned as close as possible to the back of your head. For occupants of extremely tall stature, adjust the head restraint to its full up position.



WARNING: To minimize the risk of neck injury in the event of a crash, head restraints must be installed properly.

Front row center non-adjustable head restraint (if equipped)

Vehicle's equipped with a front center seat will have head restraints that are non-adjustable.

The non-adjustable head restraints consist of:

- a trimmed energy absorbing foam and structure (1),
- two steel stems (2),
- and two guide sleeve unlock/remove buttons (3).

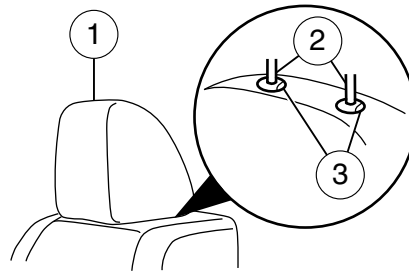

To remove the non-adjustable head restraint, do the following:

Simultaneously press and hold both unlock/remove buttons, then pull up on the head restraint.

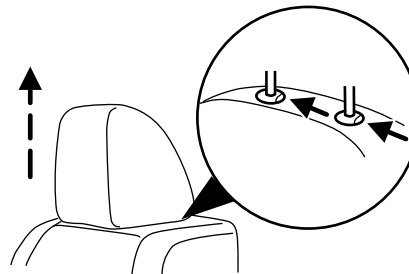

Seating and Safety Restraints

To reinstall the non-adjustable head restraint, do the following:

1. Insert the two stems into the guide sleeve collars.
2. Push the head restraint down until it locks.

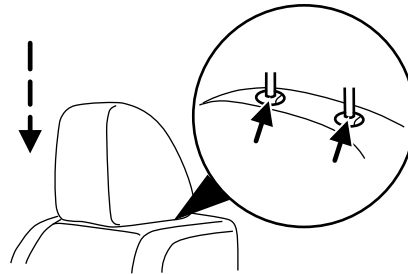

WARNING: The non-adjustable head restraint is a safety device. It should be installed whenever the seat is occupied.



WARNING: To minimize the risk of neck injury in the event of a crash, head restraints must be installed properly.

Front seat

- Lift the track release bar to move the seat forward or rearward. Make sure that the seat is relatched into place.

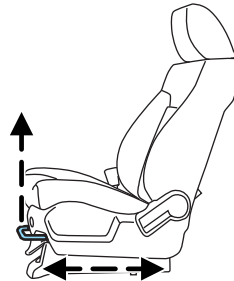

Seating and Safety Restraints

- Pull the release lever handle located on the side of the seat up to move the seatback forward or backward.

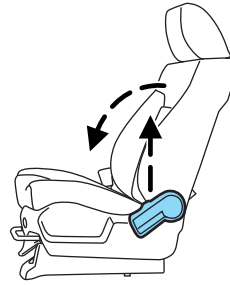

20 percent front seat armrest and console (if equipped)

To release the armrest and gain access to the cupholders and seatback storage bin, press the button on the right-hand side of the seat and pull the seatback down.

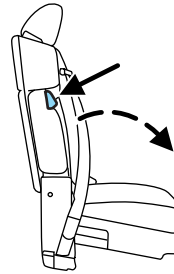

Pull up on the tab to open the storage bin.

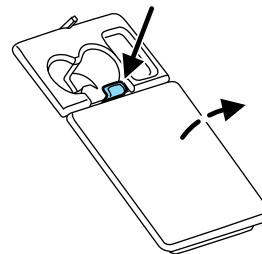

Lift up on the seatback to return it to the upright position.

Seating and Safety Restraints

To gain access to the under-seat storage compartment (if equipped) in your seat cushion, lift the latch to open the lid. The lid cannot be opened when the armrest is down.

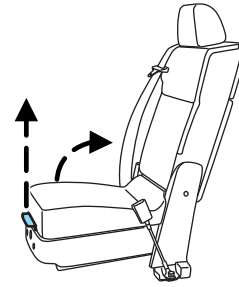

The under-seat storage compartment (if equipped) has a programmable lock. Use the ignition key to program the lock to the compartment. Electronics may be powered or charged using the under-seat storage compartment auxiliary power point. Refer to *Auxiliary power point (12VDC)* in the *Drive Controls* chapter.

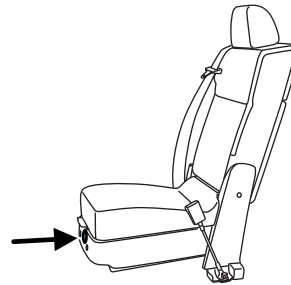

Adjusting the front power seat (if equipped)

Move the front of the control up or down to tilt the seat cushion.

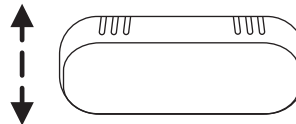

Move the rear of the control up or down to raise or lower the seat cushion.

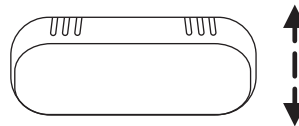

Seating and Safety Restraints

Move the control in the directions shown to move the seat forward or backward.

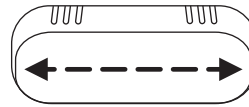

Power recline (if equipped)

Press the control to recline the seatback forward or rearward.

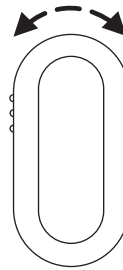

Using the power lumbar support (if equipped)

The power lumbar control is located on the outboard side of the seat.

Press one side of the control to adjust firmness.

Press the other side of the control to adjust softness.

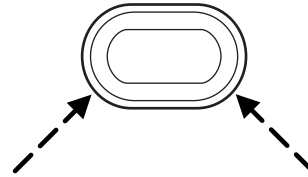

Using the manual lumbar support

The lumbar support control is located on the outboard side of the seat

Turn the lumbar support forward toward the front of the vehicle for more support.

Turn the lumbar support backward toward the rear of the vehicle for less support.

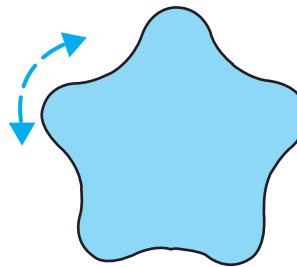

Seating and Safety Restraints

Heated and cooled seats (if equipped)

The controls for the climate controlled seats are located on the dual electronic automatic temperature control (DEATC) system.

Heated seats

 **WARNING:** Persons who are unable to feel pain to the skin because of advanced age, chronic illness, diabetes, spinal cord injury, medication, alcohol use, exhaustion, or other physical conditions, must exercise care when using the seat heater. The seat heater may cause burns even at low temperatures, especially if used for long periods of time. Do not place anything on the seat that insulates against heat, such as a blanket or cushion, because this may cause the seat heater to overheat. Do not puncture the seat with pins, needles, or other pointed objects because this may damage the heating element which may cause the seat heater to overheat. An overheated seat may cause serious personal injury.

Note: Do not do the following:

- Place heavy objects on the seat
- Operate the seat heater if water or any other liquid is spilled on the seat. Allow the seat to dry thoroughly.

The heated seats will only function when the engine is running.

To operate the heated seats:

Press once to activate the high heat setting (three indicator lights). Continue pressing to scroll through the other settings; medium heat (two indicator lights), low heat (one indicator light) or off.



Cooled seats

The cooled seats will only function when the engine is running.

To operate the cooled seats:

Press once to activate the high cool setting (three indicator lights). Continue pressing to scroll through the other settings; medium cool (two indicator lights), low cool (one indicator light) or off.



Seating and Safety Restraints

If the engine falls below 350 rpm while the cooled seats are on, the feature will turn itself off and will need to be reactivated.

Climate controlled seats air filter replacement (if equipped)

The climate controlled seat system includes air filters that must be replaced periodically. Refer to the *scheduled maintenance information* for more information.

- There is a filter located under the rear of each front seat.

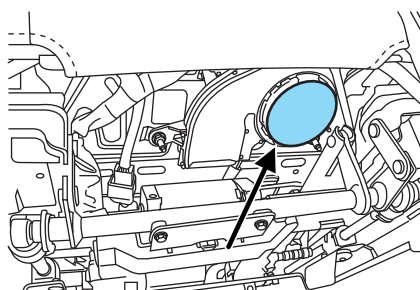

- The filter can be accessed from the second row seat. Move the front seats all the way forward and up to ease access.

To remove an air filter:

1. Remove key from ignition.
2. Push up on the outside rigid edge of the filter and rotate toward the front of the vehicle once tabs are released.

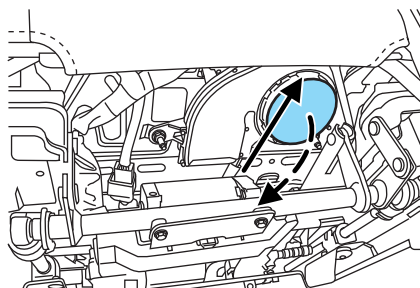

3. Remove filter.

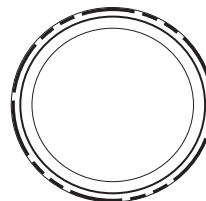

Seating and Safety Restraints

To install a filter:

1. Position the filter in its housing making sure that the far forward end is all the way up in the housing.
2. Push in on the center of the outside edge of the filter and rotate up into the housing until it clips into position.

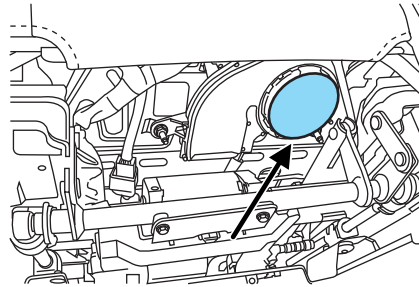

Memory seats/power mirrors/adjustable pedals (if equipped)

This system allows automatic positioning of the driver seat, power mirrors, and adjustable pedals to two programmable positions.

The memory seat control is located on the driver's door.

- To program position 1, move the driver seat and mirrors to the desired position using the associated controls. Press and hold button 1 for at least two seconds. A chime will sound confirming that a memory position has been set.
 - To program position 2, repeat the previous procedure using button 2.
- A memory seat position may be programmed at any time.

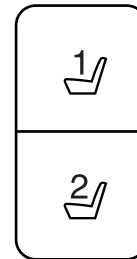

To program the memory feature to a remote entry transmitter, refer to *Remote entry system* in the *Locks and Security* chapter.

A programmed memory position can be recalled:

- in any gearshift position if the ignition is **not** on.
- only in P (Park) or N (Neutral) if the ignition is on.

The memory positions are also recalled when you press your remote entry transmitter  (unlock) control (if the transmitter is programmed to a memory position) or, when you enter a valid personal entry code that is programmed to a memory position. The mirrors will move to the programmed position and the seat will move to the easy entry position.

160

Seating and Safety Restraints

The seat will move to the final position when the key is in the ignition (if easy entry feature is enabled).

Easy-access/easy-out feature (if equipped)

The easy entry feature automatically moves the driver's seat 2 inches (5 cm) forward when:

- the transmission is in P (Park)
- the key is inserted into the ignition cylinder

(If the seat is located less than 2 inches [5 cm] from the front of the seat track, the seat will travel up to ¼ inch (6 mm) to the front of the seat track).

The easy out feature automatically moves the driver's seat 2 inches (5 cm) backward when:

- the transmission is in P (Park)
- the key is removed from the ignition cylinder

(If the seat is located less than 2 inches (5 cm) from the rear of the seat track, the seat will travel up to ¼ inch (6 mm) to the rear of the seat track).

If the memory setting is programmed through the remote transmitter, upon unlocking the door via remote entry system, the seat position will travel to the desired memory setting less 2 inches (5 cm). Once entering the vehicle and inserting the key in the ignition while in P (Park), the easy entry feature will move the seat an additional 2 inches (5 cm) to the desired memory location. See *Locks and Security* for activating the memory seat feature through the remote entry system.

Deactivating/activating the easy access/easy out feature

The easy entry/exit feature can be turned off or on through the vehicle message center (if equipped). If your vehicle does not have a message center, the feature can be turned off or on through the following process:

1. Put the key into the ignition (The driver seat may move forward if the easy entry/exit feature is activated).
2. Place the ignition key into the on position (do not start the vehicle). When the vehicle is in the on position, the interior and exterior lights, the climate controls, and the radio are functional without the engine started. See *Programming remote transmitters* for ignition switch diagram.
3. Turn the ignition key to the off position.

Seating and Safety Restraints

4. Cycle the ignition key between the off position and the on position a total of three times ending with the ignition in the off position.

5. Engage the forward or rearward seat switch.

6. Remove the ignition key from the ignition switch. (The driver seat may move rearward if the easy entry/exit feature is activated).

Steps 2 through 6 must be performed within a 20 second period. The easy entry/exit feature will be deactivated. Repeating the above process will also reactivate the easy entry/exit feature.

REAR SEATS

Non-adjustable second-row head restraints

Your vehicle is equipped with second row outboard head restraints that are non-adjustable.

Outboard head restraints (Crew Cab)

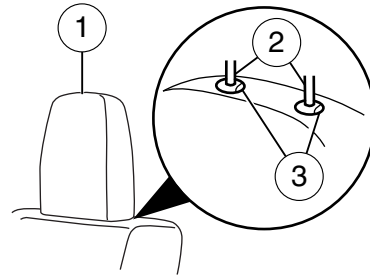

Center head restraint (Crew Cab)

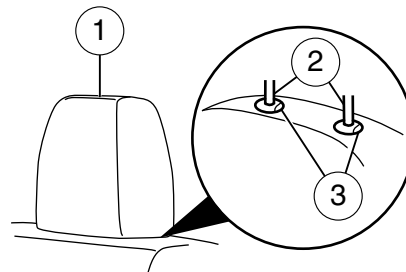

The non-adjustable second row head restraints consist of :

- a trimmed energy absorbing foam and structure (1),
- two steel stems (2),
- and two guide sleeve unlock/remove buttons (3).

162

Seating and Safety Restraints

Removal of the second-row non-adjustable head restraints is the same as the front row center head restraint. Refer to *Front-row center non-adjustable head restraint* in this chapter.



WARNING: The non-adjustable head restraint is a safety device. It should be installed whenever the seat is occupied.



WARNING: To minimize the risk of neck injury in the event of a crash, head restraints must be installed properly.

Note: The SuperCab has rear outboard head restraints that are not removable and are bolted to the back wall.

Folding up the rear seats (SuperCab)

1. Pull control to release seat cushion.
2. Rotate seat cushion up until it locks into vertical storage position.

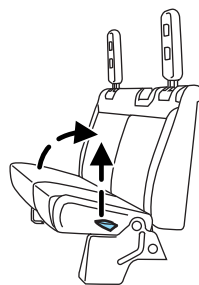

Returning the seat to seating position



WARNING: Make sure that cargo or any objects are not trapped underneath the seat cushion before returning the seat cushion to its original position, and that the seat cushion locks into place. Failure to do so may prevent the seat from operating properly in the event of a crash, which could increase the risk of serious injury.

1. Pull control on the side of the seat to release seat cushion from storage position.
2. Push seat cushion down until it locks into horizontal position.

Seating and Safety Restraints

Folding the rear seatback (Crew Cab)

1. Pull forward on the control to fold down the seatback.
2. Pull down on the handle and lift up on the seatback to return it to the original position.

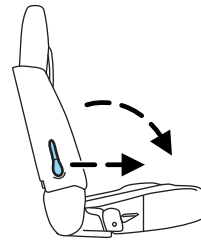

Folding up the rear seat cushion

1. Pull control to release seat cushion.
2. Rotate seat cushion up until it locks into vertical storage position.

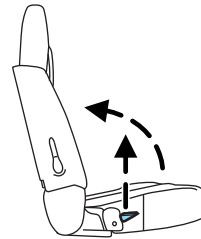

Returning the seat to the seating position



WARNING: Make sure that cargo or any objects are not trapped underneath the seat cushion before returning the seat cushion to its original position, and that the seat cushion locks into place. Failure to do so may prevent the seat from operating properly in the event of a crash, which could increase the risk of serious injury.

1. Pull control on the side of the seat to release seat cushion from storage position.
2. Push seat cushion down until it locks into horizontal position.

Seating and Safety Restraints

Rear center armrest (if equipped)

To use the armrest simply rotate it forward from the seatback.

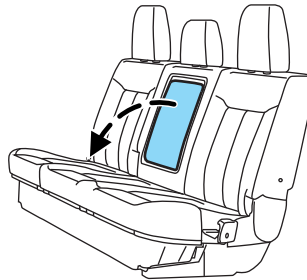

Rear under seat storage (if equipped) (Crew Cab)

The rear seat has storage space located under the seat cushion.

Lift up the lever and flip up the seat cushion to access the storage space and the power point (1).

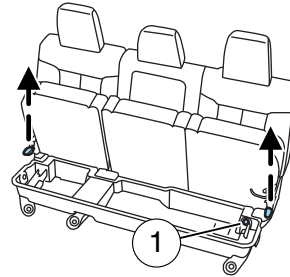

To remove the storage space divider, squeeze the sides and lift it from the storage tub.

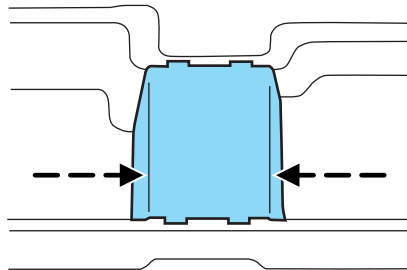

Seating and Safety Restraints

Use your vehicle key to lock the storage space.

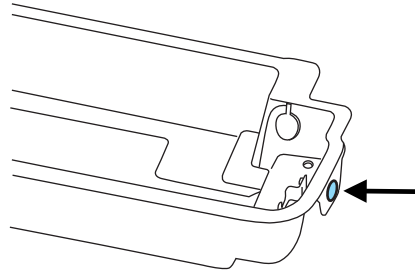

SAFETY RESTRAINTS

Safety restraints precautions



WARNING: Always drive and ride with your seatback upright and the lap belt snug and low across the hips.



WARNING: To reduce the risk of injury, make sure children sit in a rear seating position where they can be properly restrained.



WARNING: Never let a passenger hold a child on his or her lap while the vehicle is moving. The passenger cannot protect the child from injury in a collision.



WARNING: All occupants of the vehicle, including the driver, should always properly wear their safety belts, even when an airbag supplemental restraint system (SRS) is provided.



WARNING: It is extremely dangerous to ride in a cargo area, inside or outside of a vehicle. In a collision, people riding in these areas are more likely to be seriously injured or killed. Do not allow people to ride in any area of your vehicle that is not equipped with seats and safety belts. Be sure everyone in your vehicle is in a seat and using a safety belt properly.

Seating and Safety Restraints



WARNING: In a rollover crash, an unbelted person is significantly more likely to die than a person wearing a safety belt.



WARNING: Each seating position in your vehicle has a specific safety belt assembly which is made up of one buckle and one tongue that are designed to be used as a pair. 1) Use the shoulder belt on the outside shoulder only. Never wear the shoulder belt under the arm. 2) Never swing the safety belt around your neck over the inside shoulder. 3) Never use a single belt for more than one person.



WARNING: When possible, all children 12 years old and under should be properly restrained in a rear seating position.



WARNING: Safety belts and seats can become hot in a vehicle that has been closed up in sunny weather; they could burn a small child. Check seat covers and buckles before you place a child anywhere near them.



WARNING: Front and rear seat occupants, including pregnant women, should wear safety belts for optimum protection in an accident.

Combination lap and shoulder belts

1. Insert the belt tongue into the proper buckle (the buckle closest to the direction the tongue is coming from) until you hear a snap and feel it latch. Make sure the tongue is securely fastened in the buckle.

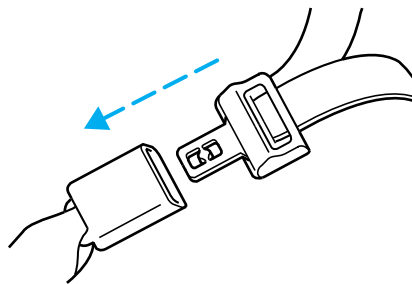

Seating and Safety Restraints

2. To unfasten, push the release button and remove the tongue from the buckle.

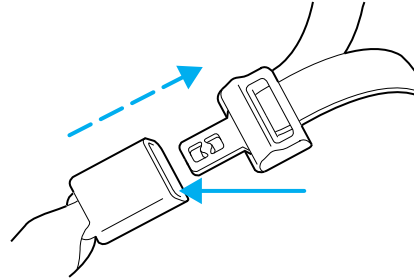

Restraint of pregnant women



WARNING: Always ride and drive with your seatback upright and the safety belt properly fastened. The lap portion of the safety belt should fit snug and be positioned low across the hips. The shoulder portion of the safety belt should be positioned across the chest. Pregnant women should also follow this practice. See figure below.

Pregnant women should always wear their safety belt. The lap belt portion of a combination lap and shoulder belt should be positioned low across the hips below the belly and worn as tight as comfort will allow. The shoulder belt should be positioned to cross the middle of the shoulder and the center of the chest.



Vehicle sensitive mode

Combination lap and shoulder belts in normal retractor mode allow free shoulder belt length adjustment to your movements and locking in response to vehicle movement. For example, if the driver brakes suddenly or turns a corner sharply, or the vehicle receives an impact of approximately 5 mph (8 km/h) or more, the combination safety belts will lock to help reduce forward movement of the driver and passengers.

Belt sensitive mode

Combination lap and shoulder belts can also be made to lock manually by quickly pulling on the shoulder belt.

168

Seating and Safety Restraints

Automatic locking mode

When to use the automatic locking mode

In this mode, the shoulder belt is automatically pre-locked. The belt will still retract to remove any slack in the shoulder belt. The automatic locking mode is not available on the driver safety belt.

This mode should be used **any time** a child safety seat (except a booster) is installed in a passenger front or outboard rear seating position (if equipped). Children 12 years old and under should be properly restrained in the rear seat whenever possible. Refer to *Safety restraints for children* or *Safety seats for children* later in this chapter.

How to use the automatic locking mode

- Buckle the combination lap and shoulder belt.

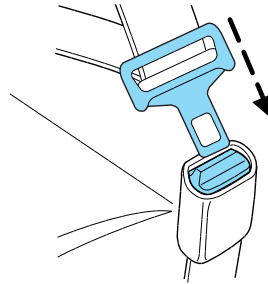

- Grasp the shoulder portion and pull downward until the entire belt is pulled out.



- Allow the belt to retract. As the belt retracts, you will hear a clicking sound. This indicates the safety belt is now in the automatic locking mode.

Seating and Safety Restraints

How to disengage the automatic locking mode

Disconnect the combination lap/shoulder belt and allow it to retract completely to disengage the automatic locking mode and activate the vehicle sensitive (emergency) locking mode.



WARNING: After any vehicle collision, the front passenger and rear outboard safety belt systems must be checked by an authorized dealer to verify that the “automatic locking retractor” feature for child seats is still functioning properly. In addition, all safety belts should be checked for proper function.



WARNING: BELT AND RETRACTOR ASSEMBLY MUST BE REPLACED if the safety belt assembly “automatic locking retractor” feature or any other safety belt function is not operating properly when checked by an authorized dealer. Failure to replace the belt and retractor assembly could increase the risk of injury in collisions.

Energy management feature

- This vehicle has a safety belt system with an energy management feature at the front outboard seating positions to help further reduce the risk of injury in the event of a head-on collision.
- The front outboard safety belt systems have a retractor assembly that is designed to pay out webbing in a controlled manner. This feature is designed to help reduce the belt force acting on the occupant’s chest.

Safety belt pretensioner

The safety belt pretensioners at the front outboard seating positions are designed to tighten the safety belts firmly against the occupant’s body during frontal collisions, and in side collisions and rollovers. This helps increase the effectiveness of the safety belts. In frontal collisions, the safety belt pretensioners can be activated alone or, if the collision is of sufficient severity, together with the front airbags.

The driver and front outboard passenger safety belt system (including retractors, buckles and height adjusters) must be replaced if the vehicle is involved in a collision that results in the activation of the safety belt pretensioners. Refer to the *Child restraint and safety belt maintenance* section in this chapter.

170

Seating and Safety Restraints



WARNING: Failure to replace the safety belt assembly under the above conditions could result in severe personal injuries in the event of a collision.

Safety belt extension assembly

If the safety belt is too short when fully extended, there is an 8 inch (20 cm) safety belt extension assembly that can be added (part number 611C22). This assembly can be obtained from an authorized dealer.

Use only extensions manufactured by the same supplier as the safety belt. Manufacturer identification is located at the end of the webbing on the label. Also, use the safety belt extension only if the safety belt is too short for you when fully extended.



WARNING: Do not use extensions to change the fit of the shoulder belt across the torso.

Front safety belt height adjustment

Your vehicle has safety belt height adjustments at the front outboard seating positions. Adjust the height of the shoulder belt so the belt rests across the middle of your shoulder.

To adjust the shoulder belt height, pull on the center button and slide the height adjuster down. Release the button and pull down on the height adjuster to make sure it is locked in place. To adjust the belt upward, slide the adjuster up and then pull down on the height adjuster to make sure it is locked in place.

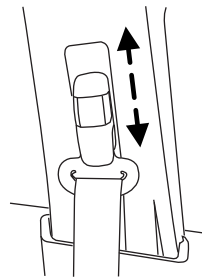

WARNING: Position the safety belt height adjusters so that the belt rests across the middle of your shoulder. Failure to adjust the safety belt properly could reduce the effectiveness of the safety belt and increase the risk of injury in a collision.

Seating and Safety Restraints

Safety belt warning light and indicator chime

The safety belt warning light illuminates in the instrument cluster and a chime sounds to remind the occupants to fasten their safety belts.

Conditions of operation

If...	Then...
The driver's safety belt is not buckled before the ignition switch is turned to the on position...	The safety belt warning light illuminates 1-2 minutes and the warning chime sounds 4-8 seconds.
The driver's safety belt is buckled while the indicator light is illuminated and the warning chime is sounding...	The safety belt warning light and warning chime turn off.
The driver's safety belt is buckled before the ignition switch is turned to the on position...	The safety belt warning light and indicator chime remain off.

Belt-Minder®

The Belt-Minder® feature is a supplemental warning to the safety belt warning function. This feature provides additional reminders to the driver that the driver's safety belt is unbuckled by intermittently sounding a chime and illuminating the safety belt warning lamp in the instrument cluster.

If...	Then...
The driver's safety belt is not buckled before the vehicle has reached at least 3 mph (5 km/h) and 1-2 minutes have elapsed since the ignition switch has been turned to the on position...	The Belt-Minder® feature is activated - the safety belt warning light illuminates and the warning chime sounds for six seconds every 30 seconds, repeating for approximately five minutes or until safety belt is buckled.
The driver's safety belt is buckled while the safety belt indicator light is illuminated and the safety belt warning chime is sounding...	The Belt-Minder® feature will not activate.

Seating and Safety Restraints

If...	Then...
The driver's safety belt is buckled before the ignition switch is turned to the on position...	The Belt-Minder® feature will not activate.

The following are reasons most often given for not wearing safety belts (All statistics based on U.S. data):

Reasons given...	Consider...
"Crashes are rare events"	36700 crashes occur every day. The more we drive, the more we are exposed to "rare" events, even for good drivers. <i>1 in 4 of us will be seriously injured in a crash during our lifetime.</i>
"I'm not going far"	3 of 4 fatal crashes occur within 25 miles (40 km) of home.
"Belts are uncomfortable"	We design our safety belts to enhance comfort. If you are uncomfortable - try different positions for the safety belt upper anchorage and seatback which should be as upright as possible; this can improve comfort.
"I was in a hurry"	Prime time for an accident. Belt-Minder® reminds us to take a few seconds to buckle up.
"Safety belts don't work"	Safety belts , when used properly, reduce risk of death to front seat occupants by 45% in cars , and by 60% in light trucks .
"Traffic is light"	Nearly 1 of 2 deaths occur in single-vehicle crashes , many when no other vehicles are around.
"Belts wrinkle my clothes"	Possibly, but a serious crash can do much more than wrinkle your clothes, particularly if you are unbelted.

Seating and Safety Restraints

Reasons given...	Consider...
“The people I’m with don’t wear belts”	Set the example, teen deaths occur 4 times more often in vehicles with TWO or MORE people. Children and younger brothers/sisters imitate behavior they see.
“I have an airbag”	Airbags offer greater protection when used with safety belts. Frontal airbags are not designed to inflate in rear and side crashes or rollovers.
“I’d rather be thrown clear”	Not a good idea. People who are ejected are 40 times more likely to DIE . Safety belts help prevent ejection, WE CAN’T “PICK OUR CRASH”.



WARNING: Do not sit on top of a buckled safety belt or insert a latchplate into the buckle to avoid the Belt-Minder® chime. To do so may adversely affect the performance of the vehicle’s airbag system.

Deactivating/activating the Belt-Minder® feature (Driver only)

Note: If you are using MyKey™, the Belt-Minder® cannot be disabled. Also, if the Belt-Minder® has been previously disabled, it will be re-enabled during the use of MyKey™. Refer to *MyKey™* in the *Locks and Security* chapter.

The Belt-Minder® feature can be deactivated/activated by performing the following procedure:

Before following the procedure, make sure that the following conditions are met:

- the parking brake is set
- the gearshift is in P (Park)
- the ignition switch is in the off position
- all vehicle doors are closed
- the driver’s safety belt is unbuckled
- the parklamps/headlamps are in the off position

174

Seating and Safety Restraints



WARNING: While the design allows you to deactivate your Belt-Minder®, this system is designed to improve your chances of being safely belted and surviving an accident. We recommend you leave the Belt-Minder® system activated for yourself and others who may use the vehicle. To reduce the risk of injury, do not deactivate/activate the Belt-Minder® feature while driving the vehicle.

Belt-Minder® activation and deactivation procedure

Read Steps 1 - 5 thoroughly before proceeding with the deactivation/activation programming procedure.

1. Turn the ignition switch to the on position. (DO NOT START THE ENGINE)
2. Wait until the safety belt warning light turns off. (approximately one minute)
 - Step 3 must be completed within 30 seconds after the safety belt warning light turns off.
3. Buckle then unbuckle the safety belt three times at a moderate speed, ending with the safety belt in the unbuckled state.
 - After Step 3 is complete, the safety belt warning light will be turned on for three seconds.
 - If Step 4 does not occur within 10 seconds at the end of Step 3, Belt-Minder® will automatically exit programming mode without changing its enable status.
4. Within seven seconds of the light turning on, buckle then unbuckle the safety belt.
 - This will disable the Belt-Minder® feature if it is currently enabled. As confirmation, the safety belt warning light will flash four times per second for three seconds.
 - This will enable the Belt-Minder® feature if it is currently disabled. As confirmation, the safety belt warning light will flash four times per second for three seconds, followed by three seconds with the light off, then followed by the safety belt warning light flashing four times per second for three seconds again.

After receiving confirmation, the deactivation/activation procedure is complete.

Seating and Safety Restraints

AIRBAG SUPPLEMENTAL RESTRAINT SYSTEM (SRS)

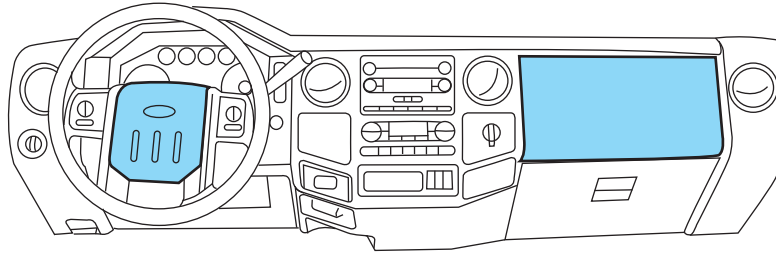

Important SRS precautions

The SRS is designed to work with the safety belt to help protect the driver and right front passenger from certain upper body injuries. Airbags DO NOT inflate slowly; there is a risk of injury from a deploying airbag.

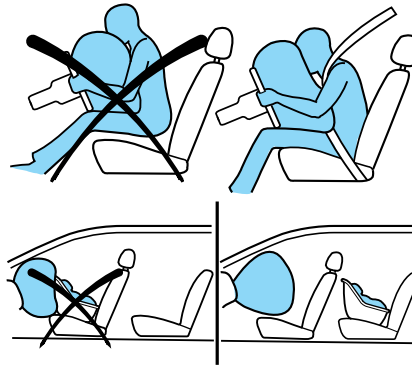

! **WARNING:** All occupants of the vehicle, including the driver, should always properly wear their safety belts, even when an air bag supplemental restraint system (SRS) is provided.

! **WARNING:** When possible, all children 12 years old and under should be properly restrained in a rear seating position.

! **WARNING:** The National Highway Traffic Safety Administration (NHTSA) recommends a minimum distance of at least 10 inches (25 cm) between an occupant's chest and the driver airbag module.

Seating and Safety Restraints



WARNING: Never place your arm over the airbag module as a deploying airbag can result in serious arm fractures or other injuries.

To properly position yourself away from the airbag:

- Move your seat to the rear as far as you can while still reaching the pedals comfortably.
- Recline the seat slightly one or two degrees from the upright position.



WARNING: Do not put anything on or over the airbag module. Placing objects on or over the airbag inflation area may cause those objects to be propelled by the airbag into your face and torso causing serious injury.



WARNING: Do not attempt to service, repair, or modify the airbag supplemental restraint systems or its fuses. Contact your authorized dealer as soon as possible.



WARNING: The front passenger airbag is not designed to offer protection to an occupant in the center front seating position.



WARNING: Modifying or adding equipment to the front end of the vehicle (including frame, bumper, front end body structure and tow hooks) may affect the performance of the airbag system, increasing the risk of injury. Do not modify the front end of the vehicle.



WARNING: Additional equipment such as snowplow equipment may effect the performance of the airbag sensors increasing the risk of injury. Please refer to the *Body Builders Layout Book* for instructions about the appropriate installation of additional equipment.

Children and airbags

For additional important safety information, read all information on safety restraints in this guide.

Children must always be properly restrained. Failure to follow these instructions may increase the risk of injury in a collision.

Seating and Safety Restraints

 **WARNING:** An infant in a rear-facing seat faces a high risk of serious or fatal injuries from a deploying passenger airbag. Rear-facing infant seats should NEVER be placed in the front seats, unless the passenger airbag is turned off. See *Passenger airbag ON/OFF switch*.

 **WARNING:** Front seating positions only: If seating two adults and a child, Ford recommends properly restraining the child in the center front seating position, but only if doing so will not interfere with driving the vehicle. This arrangement provides lap and shoulder belt and airbag protection for adult occupants and an attachment method for a child restraint. If the child seat interferes with driving the vehicle and the child restraint is forward-facing, the child may be restrained in the passenger seat. Move the seat as far rearward as possible to minimize the likelihood of interaction with the front passenger airbag. Never place a rear-facing child seat in front of an active airbag. Always properly restrain all occupants, including the child in an appropriate child seat or booster.

How does the airbag supplemental restraint system work?

The airbag SRS is designed to activate when the vehicle sustains sufficient longitudinal deceleration. The fact that the airbags did not inflate in a collision does not mean that something is wrong with the system. Rather, it means the forces were not of the type sufficient to cause activation. Airbags are designed to inflate in frontal and near-frontal collisions, not rollover, side-impact, or rear-impacts.

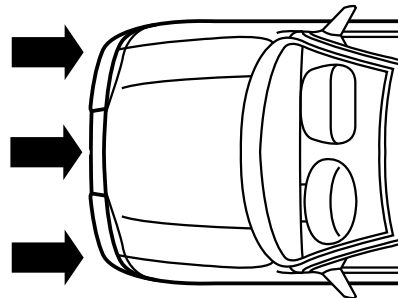

Seating and Safety Restraints

The airbags inflate and deflate rapidly upon activation. After airbag deployment, it is normal to notice a smoke-like, powdery residue or smell the burnt propellant. This may consist of cornstarch, talcum powder (to lubricate the bag) or sodium compounds (e.g., baking soda) that result from the combustion process that inflates the airbag. Small amounts of sodium hydroxide may be present which may irritate the skin and eyes, but none of the residue is toxic.



While the system is designed to help reduce serious injuries, it may also cause minor abrasions, swelling or temporary hearing loss. Because airbags must inflate rapidly and with considerable force, there is the risk of death or serious injuries such as fractures, facial and eye injuries or internal injuries, particularly to occupants who are not properly restrained or are otherwise out of position at the time of airbag deployment. Thus, it is extremely important that occupants be properly restrained as far away from the airbag module as possible while maintaining vehicle control.



WARNING: Several air bag system components get hot after inflation. Do not touch them after inflation.



WARNING: If the air bag has deployed, **the air bag will not function again and must be replaced immediately.** If the air bag is not replaced, the unrepaired area will increase the risk of injury in a collision.

The SRS consists of:

- driver and passenger airbag modules (which include the inflators and airbags),
- seat-mounted side airbags (if equipped) . Refer to *Seat-mounted side airbag system* later in this chapter
- Safety Canopy® System (if equipped). Refer to *Safety Canopy® System* later in this chapter.

Seating and Safety Restraints

- one or more impact and safing sensors,
- a readiness light and tone
- and the electrical wiring which connects the components.

The diagnostic module monitors its own internal circuits and the supplemental airbag electrical system wiring (including the impact sensors), the system wiring, the airbag system readiness light, the airbag back up power and the airbag ignitors.

Seat-mounted side airbag system (if equipped)

 **WARNING:** Do not place objects or mount equipment on or near the airbag cover on the side of the seatbacks of the front seats or in front seat areas that may come into contact with a deploying airbag. Failure to follow these instructions may increase the risk of personal injury in the event of a collision.

 **WARNING:** Do not use accessory seat covers. The use of accessory seat covers may prevent the deployment of the side airbags and increase the risk of injury in an accident.

 **WARNING:** Do not lean your head on the door. The side airbag could injure you as it deploys from the side of the seatback.

 **WARNING:** Do not attempt to service, repair, or modify the airbag SRS, its fuses or the seat cover on a seat containing an airbag. See an authorized dealer.

 **WARNING:** All occupants of the vehicle should always wear their safety belts even when an airbag SRS is provided.

Seating and Safety Restraints

How does the side airbag system work?

The design and development of the side airbag system included recommended testing procedures that were developed by a group of automotive safety experts known as the Side Airbag Technical Working Group. These recommended testing procedures help reduce the risk of injuries related to the deployment of side airbags.

The side airbag system consists of the following:

- An inflatable bag (airbag) with a gas generator concealed behind the outboard bolster of the driver and front passenger seatbacks.
- A special seat cover designed to allow airbag deployment.
- The same warning light, electronic control and diagnostic unit as used for the front airbags.
- Crash sensors located on the front doors.
- One crash sensor located on each side of the c-pillar (Crew cab and SuperCab only).

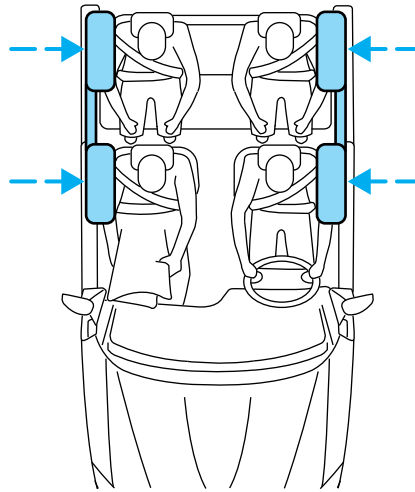

Side airbags, in combination with safety belts, can help reduce the risk of severe injuries in the event of a significant side impact collision.

The side airbags are fitted on the outboard side of the seatbacks of the front seats. In certain lateral collisions, the airbag on the side affected by the collision will be inflated. The airbag was designed to inflate between the door panel and occupant to further enhance the protection provided occupants in side impact collisions.

The airbag SRS is designed to activate when the vehicle sustains lateral deceleration sufficient to cause the sensors to close an electrical circuit that initiates airbag inflation.

The fact that the airbags did not inflate in a collision does not mean that something is wrong with the system. Rather, it means the forces were not of the type sufficient to cause activation. Side airbags are designed

Seating and Safety Restraints

to inflate in side-impact collisions, not roll-over, rear-impact, frontal or near-frontal collisions, unless the collision causes sufficient lateral deceleration.

 **WARNING:** Several airbag system components get hot after inflation. Do not touch them after inflation.

 **WARNING:** If the side airbag has deployed, **the airbag will not function again. The side airbag system (including the seat) must be inspected and serviced by an authorized dealer.** If the airbag is not replaced, the unrepaired area will increase the risk of injury in a collision.

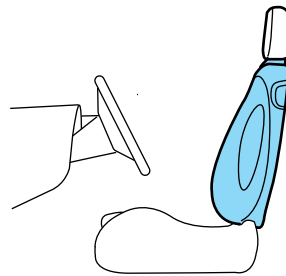

Safety Canopy® System (if equipped)

 **WARNING:** Do not place objects or mount equipment on or near the headliner at the siderail that may come into contact with a deploying Safety Canopy®. Failure to follow these instructions may increase the risk of personal injury in the event of a collision.

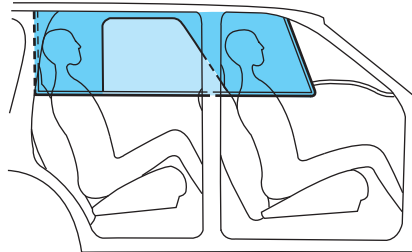

 **WARNING:** Do not lean your head on the door. The Safety Canopy® could injure you as it deploys from the headliner.

 **WARNING:** Do not attempt to service, repair, or modify the Safety Canopy® System, its fuses, the A, B, or C pillar trim, or the headliner on a vehicle containing a Safety Canopy®. Contact your authorized dealer as soon as possible.

Seating and Safety Restraints

 **WARNING:** All occupants of the vehicle including the driver should always wear their safety belts even when an airbag SRS and Safety Canopy® System is provided.

 **WARNING:** To reduce risk of injury, do not obstruct or place objects in the deployment path of the inflatable Safety Canopy®.

How does the Safety Canopy® System work?

The design and development of the Safety Canopy® system included recommended testing procedures that were developed by a group of automotive safety experts known as the Side Airbag Technical Working Group. These recommended testing procedures help reduce the risk of injuries related to the deployment of side airbags (including the Safety Canopy®).

The Safety Canopy® System consists of the following:

- An inflatable curtain with a gas generator concealed behind the headliner between the A and C pillar.
- A headliner designed to flex open above the side doors to allow Safety Canopy® deployment.
- The same warning light, electronic control and diagnostic unit as used for the front airbags.
- Two crash sensors located on the C-pillar (one on each side) (SuperCab and Crew Cab only).
- Crash sensors located on the front doors.
- Rollover sensor in the restraints control module (RCM).

The Safety Canopy® System, in combination with safety belts, can help reduce the risk of severe injuries in the event of a significant side impact collision or rollover event.

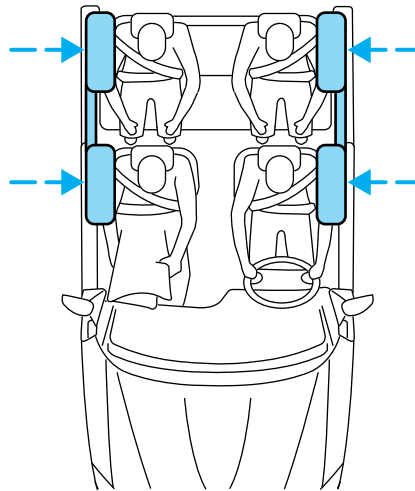

Seating and Safety Restraints

Children 12 years old and under should always be properly restrained in the second row seats. The Safety Canopy® will not interfere with children restrained using a properly installed child or booster seat because it is designed to inflate downward from the headliner above the doors along the side window opening.

The Safety Canopy® System is designed to activate when the vehicle sustains lateral deceleration sufficient to cause the RCM to initiate Safety Canopy® inflation or when a certain likelihood of a rollover event is detected by the rollover sensor.

The Safety Canopy® is mounted to roof side-rail sheet metal, behind the headliner, above each row of seats. The Safety Canopy® is designed to inflate between the side window area and occupants to further enhance protection provided in side impact collisions and rollover events.

The fact that the Safety Canopy® did not activate in a collision does not mean that something is wrong with the system. Rather, it means the forces were not of the type sufficient to cause activation. The Safety Canopy® is designed to inflate in certain side impact collisions or rollover events, not in rear impact, frontal or near-frontal collisions, unless the collision causes sufficient lateral deceleration or rollover likelihood.

 **WARNING:** Several Safety Canopy® System components get hot after inflation. Do not touch them after inflation.

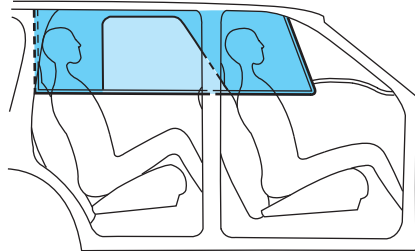

 **WARNING:** If the Safety Canopy® System has deployed, the Safety Canopy® will not function again unless replaced. The Safety Canopy® System (including the A, B, C, and D pillar trim and headliner) must be inspected and serviced by an authorized dealer. If the Safety Canopy® is not replaced, it will not function again, which will increase the risk of injury in a future collision.

Seating and Safety Restraints

Determining if the system is operational

The SRS uses a readiness light in the instrument cluster or a tone to indicate the condition of the system. Refer to *Warning lights and chimes* in the *Instrument Cluster* chapter. Routine maintenance of the side airbag is not required.

A difficulty with the system is indicated by one or more of the following:

- The readiness light (same light as for front airbag system) will either flash or stay lit.
- The readiness light will not illuminate immediately after ignition is turned on.
- A series of five beeps will be heard. The tone pattern will repeat periodically until the problem and/or light are repaired.

If any of these things happen, even intermittently, have the SRS serviced at your authorized dealer immediately. Unless serviced, the system may not function properly in the event of a collision.

SOS Post-Crash Alert System™

The system automatically flashes the turn signal lamps and sounds the horn three times at four second intervals in the event of a serious impact that deploys an airbag (front, side, side curtain or Safety Canopy®) or the safety belt pretensioners.

The system can be turned off when any one of the following actions are taken by the driver or any other person:

- pressing the hazard control button,
- or pressing the panic button on the remote entry transmitter.

The feature will continue to operate until the vehicle runs out of power.

Seating and Safety Restraints

Passenger airbag ON/OFF switch (if equipped)

 **WARNING:** An airbag ON/OFF switch may be installed in this vehicle. Before driving, *always* look at the face of the switch to be sure the switch is in the proper position in accordance with these instructions and warnings. Failure to put the switch in a proper position can increase the risk of serious injury or death in a collision.

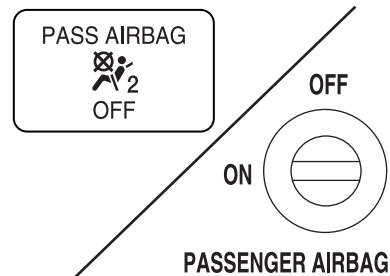

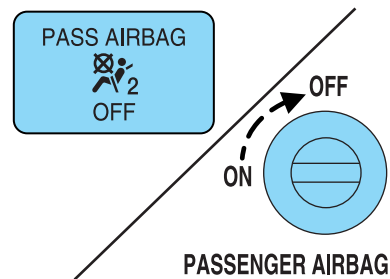

Turning the passenger airbag off

1. Insert the ignition key, turn the switch to OFF position and hold in the OFF position while removing the key.
2. When the ignition is turned to the on position the "pass airbag off" light illuminates briefly, momentarily shuts off and then turns back on. This indicates that the passenger airbag is deactivated.



 **WARNING:** If the light fails to illuminate when the passenger air bag switch is in the OFF position and the ignition switch is in on, have the passenger air bag switch serviced at your authorized dealer immediately.

 **WARNING:** In order to avoid inadvertent activation of the switch, always remove the ignition key from the passenger air bag ON/OFF switch.

 **WARNING:** An infant in a rear-facing seat faces a high risk of serious or fatal injuries from a deploying passenger airbag. Rear facing infant seats should NEVER be placed in the front seats, unless the passenger airbag is turned off.

Seating and Safety Restraints

Turning the passenger airbag back on

The passenger airbag remains off until you turn it back on.

1. Insert the ignition key and turn the switch to ON.
2. The “pass airbag off” light will briefly illuminate when the ignition is turned to on. This indicates that the passenger airbag is operational.

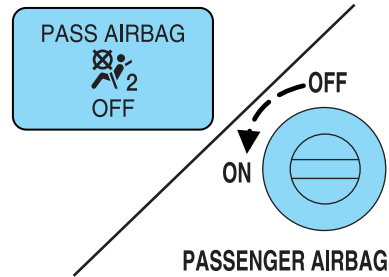

WARNING: If the “pass airbag off” light is illuminated when the passenger airbag switch is in the ON position and the ignition switch is in on, have the passenger airbag switch serviced at your authorized dealer immediately.

The passenger side airbag should always be ON (the “pass airbag off” light should *not* be illuminated) unless the passenger is a person who meets the requirements stated either in Category 1, 2 or 3 of the NHTSA/Transport Canada deactivation criteria which follows.

WARNING: The safety belts for the driver and right front passenger seating positions have been specifically designed to function together with the airbags in certain types of crashes. When you turn OFF your airbag, you not only lose the protection of the airbag, you also may reduce the effectiveness of your safety belt system, which was designed to work with the airbag. If you are not a person who meets the requirements stated in the NHTSA/Transport Canada deactivation criteria turning OFF the airbag can increase the risk of serious injury or death in a collision.

WARNING: If your vehicle has rear seats, always transport children who are 12 and younger in the rear seat. Always use safety belts and child restraints properly. DO NOT place a child in a rear facing infant seat in the front seat unless your vehicle is equipped with an airbag ON/OFF switch and the passenger airbag is turned OFF. This is because the back of the infant seat is too close to the inflating airbag and the risk of a fatal injury to the infant when the airbag inflates is substantial.

Seating and Safety Restraints

The vast majority of drivers and passengers are much safer with an airbag than without. To do their job and reduce the risk of life threatening injuries, airbags must open with great force, and this force can pose a potentially deadly risk in some situations, particularly when a front seat occupant is not properly buckled up. The most effective way to reduce the risk of unnecessary airbag injuries without reducing the overall safety of the vehicle is to make sure all occupants are properly restrained in the vehicle, especially in the front seat. This provides the protection of safety belts and permits the airbags to provide the additional protection they were designed to provide. If you choose to deactivate your airbag, you are losing the very significant risk reducing benefits of the airbag and you are also reducing the effectiveness of the safety belts, because safety belts in modern vehicles are designed to work as a safety system with the airbags.

Read all airbag warning labels in the vehicle as well as the other important airbag instructions and warnings in this Owner's Guide.

NHTSA deactivation criteria (excluding Canada)

1. **Infant.** An infant (less than 1 year old) must ride in the front seat because:
 - the vehicle has no rear seat;
 - the vehicle has a rear seat too small to accommodate a rear-facing infant seat; or
 - the infant has a medical condition which, according to the infant's physician, makes it necessary for the infant to ride in the front so that the driver can constantly monitor the child's condition.
2. **Child age 1 to 12.** A child age 1 to 12 must ride in the front seat because:
 - the vehicle has no rear seat;
 - although children ages 1 to 12 ride in the rear seat(s) whenever possible, children ages 1 to 12 sometimes must ride in the front because no space is available in the rear seat(s) of the vehicle; or
 - the child has a medical condition which, according to the child's physician, makes it necessary for the child to ride in the front seat so that the driver can constantly monitor the child's condition.

Seating and Safety Restraints

3. **Medical condition.** A passenger has a medical condition which, according to his or her physician:

- causes the passenger airbag to pose a special risk for the passenger; and
- makes the potential harm from the passenger airbag in a crash greater than the potential harm from turning OFF the airbag and allowing the passenger, even if belted, to hit the dashboard or windshield in a crash.



WARNING: This vehicle has special energy management safety belts for the driver and right front passenger. These particular belts are specifically designed to work with airbags to help reduce the risk of injury in a collision. The energy management safety belt is designed to give or release additional belt webbing in some accidents to reduce concentration of force on an occupant's chest and reduce the risk of certain bone fractures and injuries to underlying organs. In a crash, if the airbag is turned OFF, this energy management safety belt might permit the person wearing the belt to move forward enough to incur a serious or fatal injury. The more severe the crash, and the heavier the occupant, the greater the risk is. Be sure the airbag is turned ON for any person who does not qualify under the NHTSA deactivation criteria.

Transport Canada deactivation criteria (Canada Only)

1. **Infant:** An infant (less than 1 year old) must ride in the front seat because:

- my vehicle has no rear seat;
- the rear seat in my vehicle cannot accommodate a rear-facing infant seat; or
- the infant has a medical condition which, according to the infant's physician, makes it necessary for the infant to ride in the front seat so that the driver can monitor the infant's condition.

2. **Child age 12 or under:** A child age 12 or under must ride in the front seat because:

- my vehicle has no rear seat;
- although children age 12 and under ride in the rear seat whenever possible, children age 12 and under have no option but to sometimes ride in the front seat because rear seat space is insufficient; or
- the child has a medical condition that, according to the child's physician, makes it necessary for the child to ride in the front seat so that the driver can monitor the child's condition.

Seating and Safety Restraints

3. **Medical condition:** A passenger has a medical condition that, according to his or her physician:

- poses a special risk for the passenger if the airbag deploys; and
- makes the potential harm from the passenger airbag deployment greater than the potential harm from turning OFF the airbag and experiencing a crash without the protection offered by the airbag



WARNING: This vehicle has special energy management safety belts for the driver and right front passenger. These particular belts are specifically designed to work with airbags to help reduce the risk of injury in a collision. The energy management safety belt is designed to give or release additional belt webbing in some accidents to reduce concentration of force on an occupant's chest and reduce the risk of certain bone fractures and injuries to underlying organs. In a crash, if the airbag is turned OFF, this energy management safety belt might permit the person wearing the belt to move forward enough to incur a serious or fatal injury. The more severe the crash, and the heavier the occupant, the greater the risk is. Be sure the airbag is turned ON for any person who does not qualify under the NHTSA deactivation criteria.

Disposal of airbags and airbag equipped vehicles

See authorized dealer. Airbags MUST BE disposed of by qualified personnel.

SAFETY RESTRAINTS FOR CHILDREN

See the following sections for directions on how to properly use safety restraints for children. Also see *Airbag supplemental restraint system (SRS)* in this chapter for special instructions about using airbags.

Important child restraint precautions



WARNING: Always make sure your child is secured properly in a device that is appropriate for their height, age and weight. Child safety restraints must be purchased separately from the vehicle. Failure to follow these instructions and guidelines may result in an increased risk of serious injury or death to your child.

Seating and Safety Restraints



WARNING: All children are shaped differently. The Recommendations for Safety Restraints are based on probable child height, age and weight thresholds from NHTSA and other safety organizations or are the minimum requirements of law. Ford recommends checking with a NHTSA Certified Child Passenger Safety Technician (CPST) and consult your pediatrician to make sure your child seat is appropriate for your child, and is compatible with and properly installed in the vehicle. To locate a child seat fitting station and CPST contact the NHTSA toll free at 1-888-327-4236 or on the internet at <http://www.nhtsa.dot.gov>. In Canada, check with your local St. John Ambulance office for referral to a CPST or for further information, contact your provincial ministry of transportation, your local St. John Ambulance office at <http://www.sfa.ca>, or Transport Canada at 1-800-333-0371 (<http://www.tc.gc.ca>). Failure to properly restrain children in safety seats made especially for their height, age, and weight may result in an increased risk of serious injury or death to your child.

Recommendations for Safety Restraints for Children		
	Child size, height, weight, or age	Recommended restraint type
Infants or toddlers	Children weighing 40 lb (18 kg) or less (generally age four or younger)	Use a child safety seat (sometimes called an infant carrier, convertible seat, or toddler seat).
Small children	Children who have outgrown or no longer properly fit in a child safety seat (generally children who are less than 4 feet 9 inches (1.45 meters) tall, are greater than age four (4) and less than age twelve (12), and between 40 lbs (18 kg) and 80 lbs (36 kg) and upward to 100 lbs (45 kg) if recommended by your child restraint manufacturer)	Use a belt-positioning booster seat.
Larger children	Children who have outgrown or no longer properly fit in a belt-positioning booster seat (generally children who are at least 4 feet 9 inches (1.45 meters) tall or greater than 80 lb (36 kg) or 100 lb (45 kg) if recommended by child restraint manufacturer)	Use a vehicle safety belt having the lap belt snug and low across the hips, shoulder belt centered across the shoulder and chest, and seatback upright.

Seating and Safety Restraints

- You are required by law to properly use safety seats for infants and toddlers in the U.S. and Canada.
- Many states and provinces require that small children use approved booster seats until they reach age eight, a height of 4 ft 9 in (1.45 meters) tall, or 80 lb (36 kg). Check your local and state or provincial laws for specific requirements regarding the safety of children in your vehicle.
- When possible, always properly restrain children twelve (12) years of age and under in a rear seating position of your vehicle. Accident statistics suggest that children are safer when properly restrained in the rear seating positions than in a front seating position.

Recommendations for attaching child safety restraints for children

Note: This vehicle is not equipped with LATCH lower anchors.

Restraint Type	Child Weight	Use any attachment method as indicated below by "X"				
		LATCH (lower anchors and top tether anchor)	LATCH (lower anchors only)	Safety belt and top tether anchor	Safety belt and LATCH (lower anchors and top tether anchor)	Safety belt only
Rear facing child seat	Up to 48 lb (21 kg)		X			X
Forward facing child seat	Up to 48 lb (21 kg)	X		X	X	
Forward facing child seat	Over 48 lb (21 kg)			X	X	

Seating and Safety Restraints

 **WARNING:** Air bags can kill or injure a child in a child seat. NEVER place a rear-facing child seat in front of an active air bag. If you must use a forward-facing child seat in the front seat, move the vehicle seat all the way back. When possible, all children age 12 and under should be properly restrained in a rear seating position. If all children cannot be seated and restrained properly in a rear seating position, properly restrain the largest child in the front seat.

 **WARNING:** Always carefully follow the instructions and warnings provided by the manufacturer of any child restraint to determine if the restraint device is appropriate for your child's size, height, weight, or age. Follow the child restraint manufacturer's instructions and warnings provided for installation and use in conjunction with the instructions and warnings provided by the vehicle manufacturer. A safety seat that is improperly installed or utilized, is inappropriate for your child's height, age, or weight or does not properly fit the child may increase the risk of serious injury or death.

 **WARNING:** Never let a passenger hold a child on his or her lap while the vehicle is moving. The passenger cannot protect the child from injury in a collision, which may result in serious injury or death.

 **WARNING:** Never use pillows, books, or towels to boost a child. They can slide around and increase the likelihood of injury or death in a collision.

 **WARNING:** Always restrain an unoccupied child seat or booster seat. These objects may become projectiles in a collision or sudden stop, which may increase the risk of serious injury.

Seating and Safety Restraints



WARNING: Never place, or allow a child to place, the shoulder belt under a child's arm or behind the back because it reduces the protection for the upper part of the body and may increase the risk of injury or death in a collision.



WARNING: Do not leave children, unreliable adults, or pets unattended in your vehicle.

Transporting children

Always make sure your child is secured properly in a device that is appropriate for their age, height and weight. All children are shaped differently. The child height, age and weight thresholds provided are recommendations or the minimum requirements of law. The National Highway Traffic Safety Administration (NHTSA) provides education and training to ensure that all children ages 0 to 16 are properly restrained in the correct restraint system. Ford recommends checking with a NHTSA Certified Child Passenger Safety Technician (CPST) and your pediatrician to make sure your seat is appropriate for your child and properly installed in the vehicle. To locate a child seat fitting station and CPST contact the NHTSA toll free at **1-888-327-4236** or on the internet at <http://www.nhtsa.dot.gov>.

Follow all the safety restraint and airbag precautions that apply to adult passengers in your vehicle.

If the child is the proper height, age, and weight (as specified by your child safety seat or booster manufacturer), fits the restraint and can be restrained properly, then restrain the child in the child safety seat or with the belt-positioning booster. Remember that child seats and belt-positioning boosters vary and may be designed to fit children of different heights, ages and weights. Children who are too large for child safety seats or belt-positioning boosters (as specified by your child safety seat manufacturer) should always properly wear safety belts.

Seating and Safety Restraints

SAFETY SEATS FOR CHILDREN

Infant and/or toddler seats

Use a safety seat that is recommended for the size and weight of the child.

When installing a child safety seat:

- Review and follow the information presented in the *Airbag supplemental restraint system (SRS)* section in this chapter.
- Carefully follow all of the manufacturer's instructions included with the safety seat you put in your vehicle. If you do not install and use the safety seat properly, the child may be injured in a sudden stop or collision.

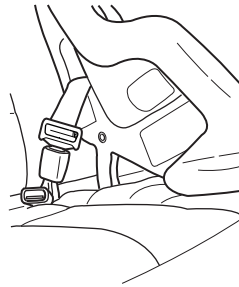

Airbags can kill or injure a child in a child seat. NEVER place a rear-facing child seat in front of an active airbag. If you must use a forward-facing child seat in the front seat, move the vehicle seat all the way back.

Children 12 and under should be properly restrained in a rear seating position whenever possible. If all children cannot be seated and restrained properly in a rear seating position, properly restrain the largest child in the front seat.

Installing child safety seats with automatic locking mode combination lap and shoulder belts (front passenger and rear outboard seating positions)

Check to make sure the child seat is properly secured before each use. Children 12 and under should be properly restrained in a rear seating position whenever possible. If all children cannot be seated and restrained properly in a rear seating position, properly restrain the largest child in the front seat.

When installing a child safety seat with combination lap/shoulder belts:

- Use the correct safety belt buckle for that seating position.
- Insert the belt tongue into the proper buckle until you hear a snap and feel it latch. Make sure the tongue is securely fastened in the buckle.

Seating and Safety Restraints

- Keep the buckle release button pointing up and away from the safety seat, with the tongue between the child seat and the release button, to prevent accidental unbuckling.
- Place vehicle seat back in upright position.
- This vehicle does not require the use of a locking clip.

 **WARNING:** Depending on where you secure a child restraint, and depending on the child restraint design, you may block access to certain safety belt buckle assemblies and/or LATCH lower anchors, rendering those features potentially unusable. To avoid risk of injury, occupants should only use seating positions where they are able to be properly restrained.

Installing the child safety seat

Perform the following steps when installing the child seat in the outboard combination lap/shoulder belts:

Note: Although the child seat illustrated is a forward facing child seat, the steps are the same for installing a rear facing child seat.

1. Position the child safety seat in a seat with a combination lap and shoulder belt.

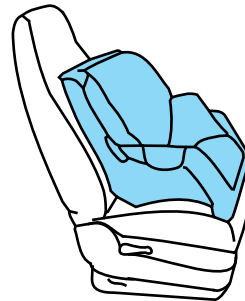

 **WARNING:** An airbag can kill or injure a child in a child seat. Child seats should NEVER be placed in the front seats, unless the passenger airbag switch is turned off, See *Passenger airbag on/off switch*.

 **WARNING:** Rear facing child seats should NEVER be placed in the front seats unless the passenger airbag switch is turned off.

Seating and Safety Restraints

2. Pull down on the shoulder belt and then grasp the shoulder belt and lap belt together.

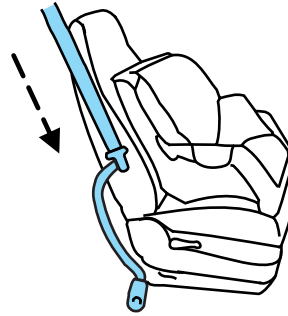

3. While holding the shoulder and lap belt portions together, route the tongue through the child seat according to the child seat manufacturer's instructions. Be sure the belt webbing is not twisted.

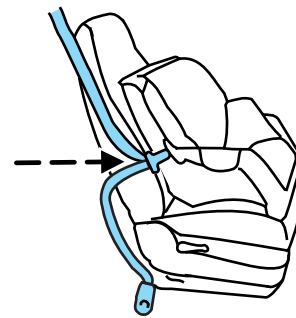

4. Insert the belt tongue into the proper buckle (the buckle closest to the direction the tongue is coming from) for that seating position until you hear and feel the latch engage. Make sure the tongue is latched securely by pulling on it.

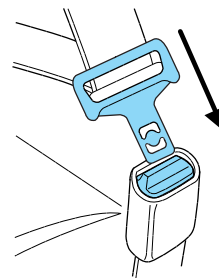

Seating and Safety Restraints

5. Put the safety belt in the automatic locking mode. To do so, grasp the shoulder portion of the belt and pull downward until all of the belt is pulled out.

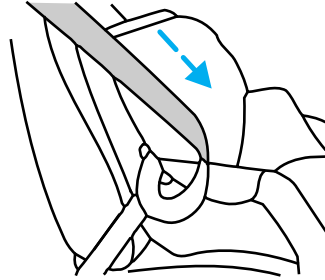

6. Allow the belt to retract to remove slack. The belt will click as it retracts to indicate it is in the automatic locking mode.

7. Try to pull the belt out of the retractor to make sure the retractor is in the automatic locking mode (you should not be able to pull more belt out). If the retractor is not locked, repeat Steps 5 and 6.

8. Remove remaining slack from the belt. Force the seat down with extra weight, e.g., by pressing down or kneeling on the child restraint while pulling up on the shoulder belt in order to force slack from the belt. This is necessary to remove the remaining slack that will exist once the additional weight of the child is added to the child restraint. It also helps to achieve the proper snugness of the child seat to the vehicle. Sometimes, a slight lean towards the buckle will additionally help to remove remaining slack from the belt.

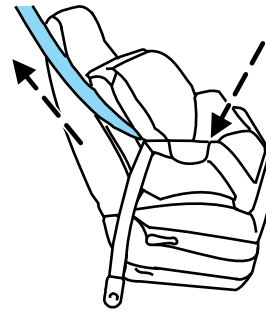

Seating and Safety Restraints

9. Attach the tether strap (if the child seat is equipped). Refer to *Attaching child safety seats with tether straps* later in this chapter.

10. Before placing the child in the seat, forcibly move the seat forward and back to make sure the seat is securely held in place. To check this, grab the seat at the belt path and attempt to move it side to side and forward. There should be no more than one inch (2.5 cm) of movement for proper installation.

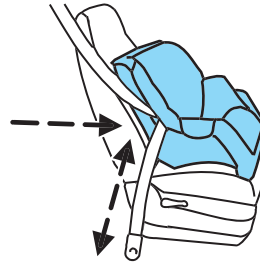

11. Ford recommends checking with a NHTSA Certified Child Passenger Safety Technician (CPST) to make certain the child restraint is properly installed. In Canada, check with your local St. John Ambulance office for referral to a CPST.

Installing child safety seats in cinch tongue combination lap and shoulder belt seating positions (All front center and Super/Crew cab rear center positions)

The belt webbing below the tongue is the lap portion of the combination lap/shoulder belt, and the belt webbing above the tongue is the shoulder belt portion of the combination lap/shoulder belt.



WARNING: Always use both lap and shoulder safety belt in the Regular Cab center seating position if applicable.

Note: Although the child seat illustrated is a forward facing child seat, the steps are the same for installing a rear facing child seat.

1. Position the child safety seat in the center seat.

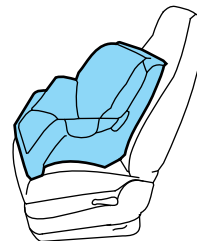

Seating and Safety Restraints

 **WARNING:** Airbags can kill or injure a child in a child seat. If you must use a forward-facing child seat in the front seat, move seat all the way back.

 **WARNING:** Rear facing child seats should NEVER be placed in front of an active airbag.

2. Slide the tongue up the webbing.

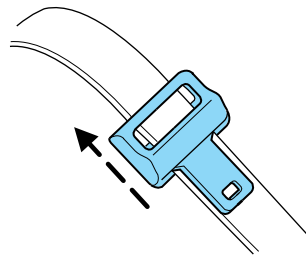

3. While holding both shoulder and lap portions next to the tongue, route the tongue and webbing through the child seat according to the child seat manufacturer's instructions. Be sure that the belt webbing is not twisted.

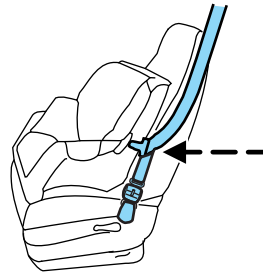

Seating and Safety Restraints

4. Insert the belt tongue into the proper buckle for that seating positions until you hear a snap and feel it latch. Make sure the tongue is securely latched to the buckle by pulling on the tongue.

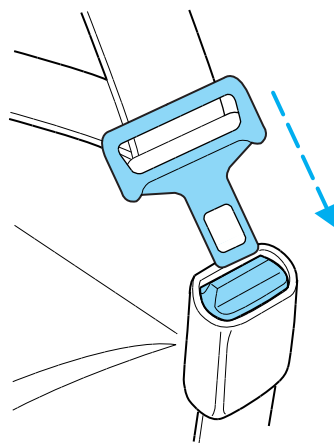

5. Remove remaining slack from the belt. Force the seat down with extra weight, e.g., by pressing down or kneeling on the child restraint while pulling up on the shoulder belt in order to force slack from the belt. This is necessary to remove the remaining slack that will exist once the additional weight of the child is added to the child restraint. It also helps to achieve the proper snugness of the child seat to the vehicle. Sometimes, a slight lean towards the buckle will additionally help to remove remaining slack from the belt.

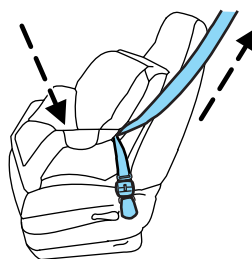

6. Attach the tether strap (if the child seat is equipped). Refer to *Attaching child safety seats with tether straps* later in this chapter.

Seating and Safety Restraints

7. Before placing the child in the seat, forcibly move the seat forward and back to make sure the seat is securely held in place. To check this, grab the seat at the belt path and attempt to move it side to side and forward. There should be no more than one inch (2.5 cm) of movement for proper installation.

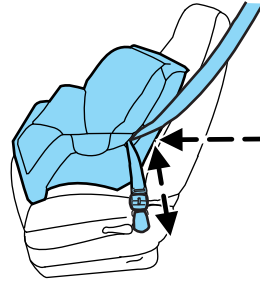

8. Ford recommends checking with a NHTSA Certified Child Passenger Safety Technician (CPST) to make certain the child restraint is properly installed. In Canada, check with your local St. John Ambulance office for referral to a CPST.

Attaching child safety seats with LATCH (Lower Anchors and Tethers for Children) attachments

The LATCH system is composed of three vehicle anchor points: two (2) lower anchors located where the vehicle seat back and seat cushion meet (called the “seat bight”) and one (1) top tether anchor located behind that seating position. Your vehicle is **not** equipped with the lower anchor points in the seat bight. For this vehicle use the vehicle safety belt and upper tether to secure a child seat. See *Attaching child safety seats with tether straps* and *Recommendations for attaching safety restraints for children* in this chapter for more information.

Attaching child safety seats with tether straps

Many forward-facing child safety seats include a tether strap which extends from the back of the child safety seat and hooks to an anchoring point called the top tether anchor. Tether straps are available as an accessory for many older safety seats. Contact the manufacturer of your child seat for information about ordering a tether strap, or to obtain a longer tether strap if the tether strap on your safety seat does not reach the appropriate top tether anchor in the vehicle.

The passenger seats of your vehicle may be equipped with built-in tether strap anchors located behind the seats as described below.

The tether anchors in your vehicle may be straps on the seatback or an anchor bracket mounted to the body shell on the back panel.

The SuperCab rear seat has three straps behind the top of the seat back that function as both routing loops for the tether straps and anchor loops.

202

Seating and Safety Restraints

The tether strap anchors in your vehicle are in the following positions (shown from top view):

- **F-Series Regular Cab**

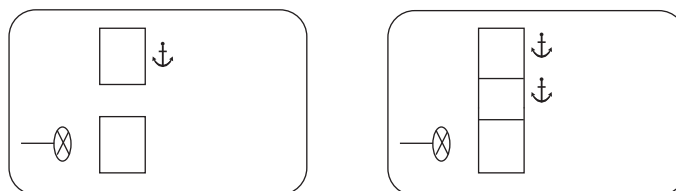

- **F-Series SuperCab**

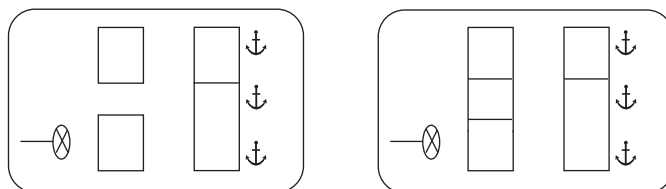

- **F-Series Crew Cab**

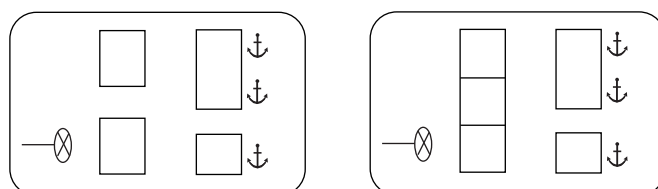

Attach the tether strap only to the appropriate tether anchor as shown. The tether strap may not work properly if attached somewhere other than the correct tether anchor.

Once the child safety seat has been installed using the safety belt, you can attach the top tether strap.

Seating and Safety Restraints

Tether strap attachment

1. Route the child safety seat tether strap over the back of the seat.

For vehicles with adjustable head restraints, route the tether strap under the head restraint and between the head restraint posts, other wise route the tether strap over the top of the seatback. If the top of the safety seat hits the head restraint, raise the head restraint to let the child seat fit further rearward.

2. Locate the correct anchor for the selected seating position.
3. You may need to pull the seatback forward to access the tether anchors. Make sure the seat is locked in the upright position before installing the child seat. Refer to the *Rear folding seat system with load floor* section in this chapter for information on how to operate the rear seats.
4. Remove tether cover.

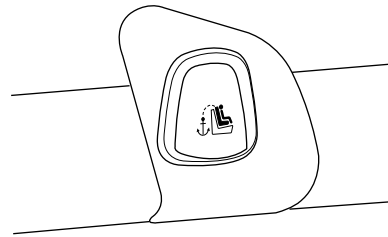

5. Clip the tether strap to the anchor as shown.

- Front seats (Regular Cab)

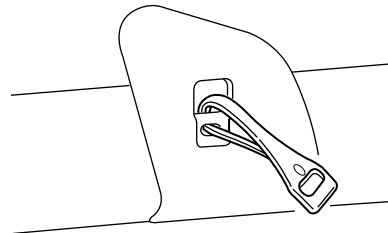

Seating and Safety Restraints

- Rear seats (Crew Cab)

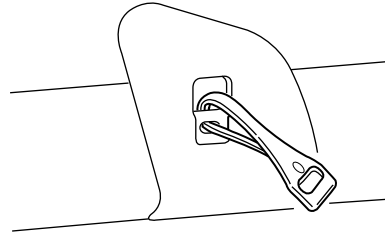

If the tether strap is clipped incorrectly, the child safety seat may not be retained properly in the event of a collision.

6. Refer to the *Installing child safety seats with automatic locking mode combination lap and shoulder belts* and *Installing child safety seats in cinch tongue combination lap and shoulder belt seating positions* sections of this chapter for further instructions to secure the child safety seat.

7. Tighten the child safety seat tether strap according to the manufacturer's instructions.

If the safety seat is not anchored properly, the risk of a child being injured in a collision greatly increases.

If your child restraint system is equipped with a tether strap, and the child restraint manufacturer recommends its use, Ford also recommends its use.

Tether strap attachment (rear SuperCab only)

There are three loops of webbing just above the back of the rear seat (along the bottom edge of the rear window) in the SuperCab. These loops are to be used as both routing loops and anchor loops for up to three child safety seat tether straps.

These straps may be secured below the back of the seat with rubber bands. To access, reach below the back of the seat and pull tether loop out of the rubber band securing it.

Seating and Safety Restraints

Many tether straps cannot be tightened if the tether strap is hooked to the loop directly behind the child seat. To provide a tight tether strap:

1. Route the tether strap through the loop directly behind the child seat.



2. Attach the strap hook onto the loop behind an adjacent seating position.

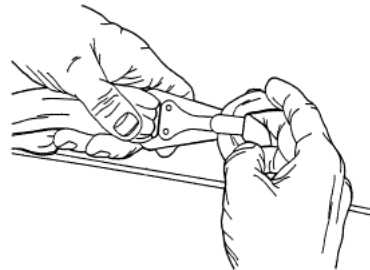

3. Install the child safety seat tightly using the vehicle belts. Follow the instructions in this chapter.

4. Tighten the tether strap according to the child seat manufacturer's instructions.

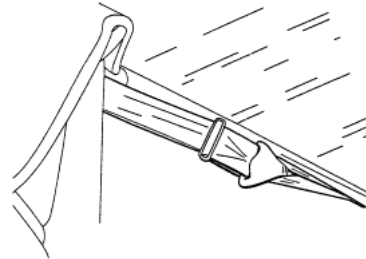

A single loop can be used to route and anchor more than one child seat. For example, the center loop can be used as a routing loop for a child safety seat in the center rear seat and as an anchoring loop for child seats installed in the outboard rear seats.

Seating and Safety Restraints

Child booster seats

The belt-positioning booster (booster seat) is used to improve the fit of the vehicle safety belt. Children outgrow a typical child seat (e.g., convertible or toddler seat) when they weigh about 40 lb (18 kg) and are around four (4) years of age. Consult your child safety seat owner guide for the weight, height, and age limits specific to your child safety seat. Keep your child in the child safety seat if it properly fits the child, remains appropriate for their weight, height and age AND if properly secured to the vehicle.

Although the lap/shoulder belt will provide some protection, children who have outgrown a typical child seat are still too small for lap/shoulder belts to fit properly, and wearing an improperly fitted vehicle safety belt could increase the risk of serious injury in a crash. To improve the fit of both the lap and shoulder belt on children who have outgrown child safety seats, Ford Motor Company recommends use of a belt-positioning booster.

Booster seats position a child so that vehicle lap/shoulder safety belts fit better. They lift the child up so that the lap belt rests low across the hips and the knees bend comfortably at the edge of the cushion, while minimizing slouching. Booster seats may also make the shoulder belt fit better and more comfortably. Try to keep the belt near the middle of the shoulder and across the center of the chest. Moving the child closer (a few centimeters or inches) to the center of the vehicle, but remaining in the same seating position, may help provide a good shoulder belt fit.

When children should use booster seats

Children need to use booster seats from the time they outgrow the toddler seat until they are big enough for the vehicle seat and lap/shoulder belt to fit properly. Generally this is when they reach a height of at least 4 feet 9 inches (1.45 meters) tall (around age eight to age twelve and between 40 lb (18 kg) and 80 lb (36 kg) or upward to 100 lb (45 kg) if recommended by your child restraint manufacturer). Many state and provincial laws require that children use approved booster seats until they reach age eight, a height of 4 feet 9 inches (1.45 meters) tall, or 80 lb (36 kg).

Seating and Safety Restraints

Booster seats should be used until you can answer YES to ALL of these questions when seated without a booster seat:

- Can the child sit all the way back against the vehicle seat back with knees bent comfortably at the edge of the seat cushion?
- Can the child sit without slouching?
- Does the lap belt rest low across the hips?
- Is the shoulder belt centered on the shoulder and chest?
- Can the child stay seated like this for the whole trip?

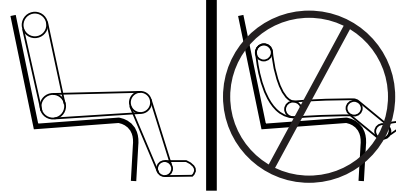

Types of booster seats

There are generally two types of belt-positioning booster seats: backless and high back. Always use booster seats in conjunction with the vehicle lap/shoulder belt.

- Backless booster seats

If your backless booster seat has a removable shield, remove the shield. If a vehicle seating position has a low seat back or no head restraint, a backless booster seat may place your child's head (as measured at the tops of the ears) above the top of the seat. In this case, move the backless booster to another seating position with a higher seat back or head restraint and lap/shoulder belts, or consider using a high back booster seat.



Seating and Safety Restraints

- High back booster seats

If, with a backless booster seat, you cannot find a seating position that adequately supports your child's head, a high back booster seat would be a better choice.



Children and booster seats vary in size and shape. Choose a booster that keeps the lap belt low and snug across the hips, never up across the stomach, and lets you adjust the shoulder belt to cross the chest and rest snugly near the center of the shoulder. The drawings below compare the ideal fit (center) to a shoulder belt uncomfortably close to the neck and a shoulder belt that could slip off the shoulder. The drawings below also show how the lap belt should be low and snug across the child's hips.

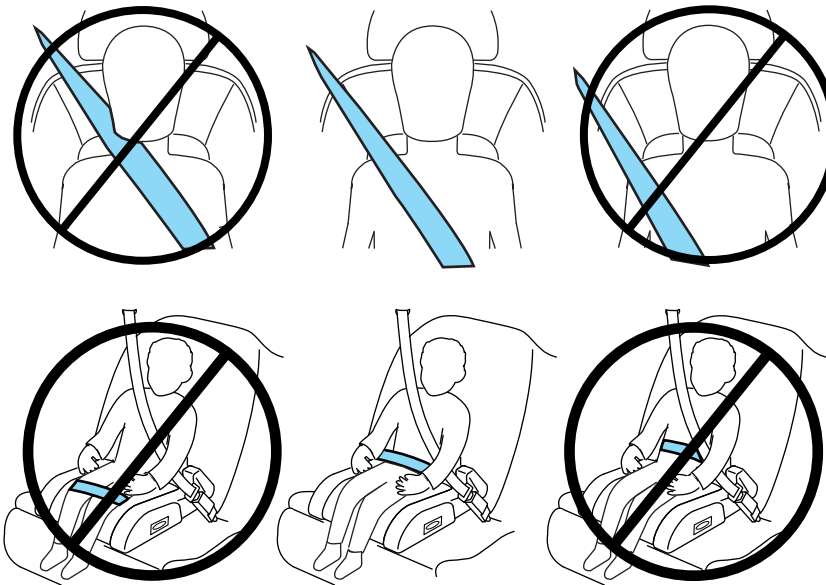

Seating and Safety Restraints

If the booster seat slides on the vehicle seat, placing a rubberized mesh sold as shelf or carpet liner under the booster seat may improve this condition. Do not introduce any item thicker than this under the booster seat. Check with the booster seat manufacturer's instructions.

The importance of shoulder belts

Using a booster without a shoulder belt increases the risk of a child's head hitting a hard surface in a collision. For this reason, you should never use a booster seat with a lap belt only. It is generally best to use a booster seat with lap/shoulder belts in the back seat.

Move a child to a different seating location if the shoulder belt does not stay positioned on the shoulder during use.

Follow all instructions provided by the manufacturer of the booster seat.



WARNING: Never place, or allow a child to place, the shoulder belt under a child's arm or behind the back because it reduces the protection for the upper part of the body and may increase the risk of injury or death in a collision.

Child restraint and safety belt maintenance

Inspect the vehicle safety belts and child safety seat systems periodically to make sure they work properly and are not damaged. Inspect the vehicle and child seat safety belts to make sure there are no nicks, tears or cuts. Replace if necessary. All vehicle safety belt assemblies, including retractors, buckles, front safety belt buckle assemblies, buckle support assemblies (slide bar-if equipped), shoulder belt height adjusters (if equipped), shoulder belt guide on seatback (if equipped), child safety seat LATCH and tether anchors, and attaching hardware, should be inspected after a collision. Refer to the child restraint manufacturer's instructions for additional inspection and maintenance information specific to the child restraint. Ford Motor Company recommends that all safety belt assemblies in use in vehicles involved in a collision be replaced. However, if the collision was minor and an authorized dealer finds that the belts do not show damage and continue to operate properly, they do not need to be replaced. Safety belt assemblies not in use during a collision should also be inspected and replaced if either damage or improper operation is noted.

Seating and Safety Restraints

For proper care of soiled safety belts, refer to *Interior* in the *Cleaning* chapter.



WARNING: Failure to inspect and if necessary replace the safety belt assembly or child restraint system under the above conditions could result in severe personal injuries in the event of a collision.

Tires, Wheels and Loading

NOTICE TO UTILITY VEHICLE AND TRUCK OWNERS

Utility vehicles and trucks handle differently than passenger cars in the various driving conditions that are encountered on streets, highways and off-road. Utility vehicles and trucks are not designed for cornering at speeds as high as passenger cars any more than low-slung sports cars are designed to perform satisfactorily under off-road conditions.

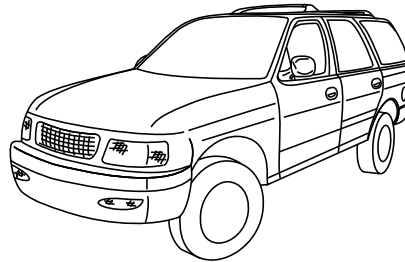

! **WARNING:** Utility vehicles have a significantly higher rollover rate than other types of vehicles. To reduce the risk of serious injury or death from a rollover or other crash you must:

- Avoid sharp turns and abrupt maneuvers;
- Drive at safe speeds for the conditions;
- Keep tires properly inflated;
- Never overload or improperly load your vehicle; and
- Make sure every passenger is properly restrained.

! **WARNING:** In a rollover crash, an unbelted person is significantly more likely to die than a person wearing a seat belt. All occupants must wear seat belts and children/infants must use appropriate restraints to minimize the risk of injury or ejection.

Study your owner's guide and any supplements for specific information about equipment features, instructions for safe driving and additional precautions to reduce the risk of an accident or serious injury.

VEHICLE CHARACTERISTICS

4WD and AWD systems (if equipped)

A vehicle equipped with AWD or 4WD (when selected) has the ability to use all four wheels to power itself. This increases traction which may enable you to safely drive over terrain and road conditions that a conventional two-wheel drive vehicle cannot.

Tires, Wheels and Loading

Power is supplied to all four wheels through a transfer case or power transfer unit. 4WD vehicles allow you to select different drive modes as necessary. Information on transfer case operation and shifting procedures can be found in the *Driving* chapter. Information on transfer case maintenance can be found in the *Maintenance and Specifications* chapter. You should become thoroughly familiar with this information before you operate your vehicle.

On some 4WD models, the initial shift from two-wheel drive to 4WD while the vehicle is moving can cause a momentary clunk and ratcheting sound. These sounds are normal as the front drivetrain comes up to speed and is not cause for concern.



WARNING: Do not become overconfident in the ability of 4WD and AWD vehicles. Although a 4WD or AWD vehicle may accelerate better than two-wheel drive vehicle in low traction situations, it won't stop any faster than two-wheel drive vehicles. Always drive at a safe speed.

How your vehicle differs from other vehicles

SUV and trucks can differ from some other vehicles in a few noticeable ways. Your vehicle may be:

- Higher – to allow higher load carrying capacity and to allow it to travel over rough terrain without getting hung up or damaging underbody components.
- Shorter – to give it the capability to approach inclines and drive over the crest of a hill without getting hung up or damaging underbody components. All other things held equal, a shorter wheelbase may make your vehicle quicker to respond to steering inputs than a vehicle with a longer wheelbase.

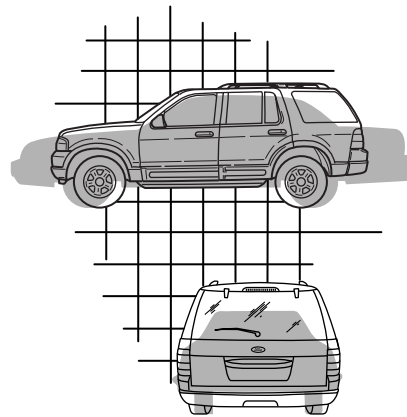

Tires, Wheels and Loading

- Narrower — to provide greater maneuverability in tight spaces, particularly in off-road use.

As a result of the above dimensional differences, SUV's and trucks often will have a higher center of gravity and a greater difference in center of gravity between the loaded and unloaded condition.

These differences that make your vehicle so versatile also make it handle differently than an ordinary passenger car.

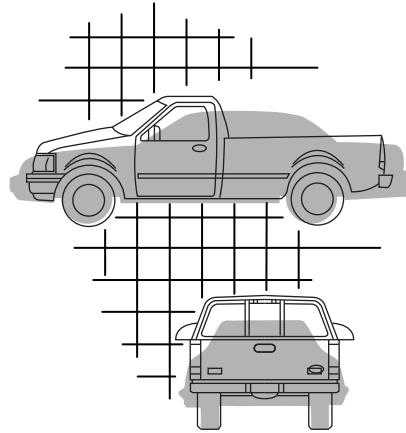

INFORMATION ABOUT UNIFORM TIRE QUALITY GRADING

Tire Quality Grades apply to new pneumatic passenger car tires. The Quality grades can be found where applicable on the tire sidewall between tread shoulder and maximum section width. For example:

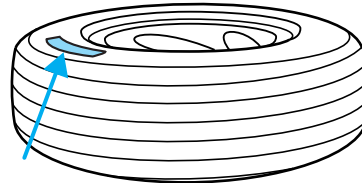

- **Treadwear 200 Traction AA Temperature A**

These Tire Quality Grades are determined by standards that the United States Department of Transportation has set.

Tire Quality Grades apply to new pneumatic passenger car tires. They do not apply to deep tread, winter-type snow tires, space-saver or temporary use spare tires, light truck or "LT" type tires, tires with nominal rim diameters of 10 to 12 inches or limited production tires as defined in Title 49 Code of Federal Regulations Part 575.104(c)(2).

U.S. Department of Transportation-Tire quality grades: The U.S. Department of Transportation requires Ford Motor Company to give you the following information about tire grades exactly as the government has written it.

Tires, Wheels and Loading

Treadwear

The treadwear grade is a comparative rating based on the wear rate of the tire when tested under controlled conditions on a specified government test course. For example, a tire graded 150 would wear one and one-half (1½) times as well on the government course as a tire graded 100. The relative performance of tires depends upon the actual conditions of their use, however, and may depart significantly from the norm due to variations in driving habits, service practices, and differences in road characteristics and climate.

Traction AA A B C

The traction grades, from highest to lowest are AA, A, B, and C. The grades represent the tire's ability to stop on wet pavement as measured under controlled conditions on specified government test surfaces of asphalt and concrete. A tire marked C may have poor traction performance.



WARNING: The traction grade assigned to this tire is based on straight-ahead braking traction tests, and does not include acceleration, cornering, hydroplaning or peak traction characteristics.

Temperature A B C

The temperature grades are A (the highest), B and C, representing the tire's resistance to the generation of heat and its ability to dissipate heat when tested under controlled conditions on a specified indoor laboratory test wheel. Sustained high temperature can cause the material of the tire to degenerate and reduce tire life, and excessive temperature can lead to sudden tire failure. The grade C corresponds to a level of performance which all passenger car tires must meet under the Federal Motor Vehicle Safety Standard No. 139. Grades B and A represent higher levels of performance on the laboratory test wheel than the minimum required by law.



WARNING: The temperature grade for this tire is established for a tire that is properly inflated and not overloaded. Excessive speed, underinflation, or excessive loading, either separately or in combination, can cause heat buildup and possible tire failure.

Tires, Wheels and Loading

TIRES

Tires are designed to give many thousands of miles of service, but they must be maintained in order to get the maximum benefit from them.

Glossary of tire terminology

- **Tire label:** A label showing the OE (Original Equipment) tire sizes, recommended inflation pressure and the maximum weight the vehicle can carry.
- **Tire Identification Number (TIN):** A number on the sidewall of each tire providing information about the tire brand and manufacturing plant, tire size and date of manufacture. Also referred to as DOT code.
- **Inflation pressure:** A measure of the amount of air in a tire.
- **Standard load:** A class of P-metric or Metric tires designed to carry a maximum load at 35 psi [37 psi (2.5 bar) for Metric tires]. Increasing the inflation pressure beyond this pressure will not increase the tire's load carrying capability.
- **Extra load:** A class of P-metric or Metric tires designed to carry a heavier maximum load at 41 psi [43 psi (2.9 bar) for Metric tires]. Increasing the inflation pressure beyond this pressure will not increase the tire's load carrying capability.
- **kPa:** Kilopascal, a metric unit of air pressure.
- **PSI:** Pounds per square inch, a standard unit of air pressure.
- **Cold inflation pressure:** The tire pressure when the vehicle has been stationary and out of direct sunlight for an hour or more and prior to the vehicle being driven for 1 mile (1.6 km).
- **Recommended inflation pressure:** The cold inflation pressure found on the Safety Compliance Certification Label or Tire Label located on the B-Pillar or the edge of the driver's door.
- **B-pillar:** The structural member at the side of the vehicle behind the front door.
- **Bead area of the tire:** Area of the tire next to the rim.
- **Sidewall of the tire:** Area between the bead area and the tread.
- **Tread area of the tire:** Area of the perimeter of the tire that contacts the road when mounted on the vehicle.
- **Rim:** The metal support (wheel) for a tire or a tire and tube assembly upon which the tire beads are seated.

216

Tires, Wheels and Loading

INFLATING YOUR TIRES

Safe operation of your vehicle requires that your tires are properly inflated. Remember that a tire can lose up to half of its air pressure without appearing flat.

Every day before you drive, check your tires. If one looks lower than the others, use a tire gauge to check pressure of all tires and adjust if required.

At least once a month and before long trips, inspect each tire and check the tire pressure with a tire gauge (including spare, if equipped). Inflate all tires to the inflation pressure recommended by Ford Motor Company.

You are strongly urged to buy a reliable tire pressure gauge, as automatic service station gauges may be inaccurate. Ford recommends the use of a digital or dial-type tire pressure gauge rather than a stick-type tire pressure gauge.

Use the recommended cold inflation pressure for optimum tire performance and wear. Under-inflation or over-inflation may cause uneven treadwear patterns.



WARNING: Under-inflation is the most common cause of tire failures and may result in severe tire cracking, tread separation or “blowout”, with unexpected loss of vehicle control and increased risk of injury. Under-inflation increases sidewall flexing and rolling resistance, resulting in heat buildup and internal damage to the tire. It also may result in unnecessary tire stress, irregular wear, loss of vehicle control and accidents. A tire can lose up to half of its air pressure and not appear to be flat!

Always inflate your tires to the Ford recommended inflation pressure even if it is less than the maximum inflation pressure information found on the tire. The Ford recommended tire inflation pressure is found on the Safety Compliance Certification Label or Tire Label which is located on the B-Pillar or the edge of the driver's door. Failure to follow the tire pressure recommendations can cause uneven treadwear patterns and adversely affect the way your vehicle handles.

Note: Do not reduce tire pressure to change the ride characteristics of the vehicle. If you do not maintain the inflation pressure at the levels specified by Ford, your vehicle may experience a condition known as “shimmy”. Shimmy is a severe vibration and oscillation in the steering wheel after the vehicle travels over a bump or dip in the road that does not dampen out by itself. Shimmy may result from significant

Tires, Wheels and Loading

under-inflation of the tires, improper tires (load range, size, or type), or vehicle modifications such as lift-kits. In the event that your vehicle experiences shimmy, you should slowly reduce speed by either lifting off the accelerator pedal or lightly applying the brakes. The shimmy will cease as the vehicle speed decreases.

Maximum Permissible Inflation Pressure is the tire manufacturer's maximum permissible pressure and/or the pressure at which the maximum load can be carried by the tire. This pressure is normally higher than the manufacturer's recommended cold inflation pressure which can be found on the Safety Compliance Certification Label or Tire Label which is located on the B-Pillar or the edge of the driver's door. The cold inflation pressure should never be set lower than the recommended pressure on the Safety Compliance Certification Label or Tire Label.

When weather temperature changes occur, tire inflation pressures also change. A 10°F (6°C) temperature drop can cause a corresponding drop of 1 psi (7 kPa) in inflation pressure. Check your tire pressures frequently and adjust them to the proper pressure which can be found on the Safety Compliance Certification Label or Tire Label.

To check the pressure in your tire(s):

1. Make sure the tires are cool, meaning they are not hot from driving even a mile.

If you are checking tire pressure when the tire is hot, (i.e. driven more than 1 mile [1.6 km]), never "bleed" or reduce air pressure. The tires are hot from driving and it is normal for pressures to increase above recommended cold pressures. A hot tire at or below recommended cold inflation pressure could be significantly under-inflated.

Note: If you have to drive a distance to get air for your tire(s), check and record the tire pressure first and add the appropriate air pressure when you get to the pump. It is normal for tires to heat up and the air pressure inside to go up as you drive.

2. Remove the cap from the valve on one tire, then firmly press the tire gauge onto the valve and measure the pressure.
3. Add enough air to reach the recommended air pressure.

Note: If you overfill the tire, release air by pushing on the metal stem in the center of the valve. Then recheck the pressure with your tire gauge.

4. Replace the valve cap.
5. Repeat this procedure for each tire, including the spare.

218

Tires, Wheels and Loading

Note: Some spare tires operate at a higher inflation pressure than the other tires. For T-type/mini-spare tires (see the *Dissimilar spare tire/wheel information* section for description): Store and maintain at 60 psi (4.15 bar). For full-size and dissimilar spare tires (see the *Dissimilar spare tire/wheel information* section for description): Store and maintain at the higher of the front and rear inflation pressure as shown on the Tire Label.

6. Visually inspect the tires to make sure there are no nails or other objects embedded that could poke a hole in the tire and cause an air leak.
7. Check the sidewalls to make sure there are no gouges, cuts or bulges.

Tire inflation information

All tires with Steel Carcass Plies (if equipped):

This type of tire utilizes steel cords in the sidewalls. As such, they cannot be treated like normal light truck tires. Tire service, including adjusting tire pressure, must be performed by personnel trained, supervised and equipped according to Federal Occupational Safety and Health Administration (OSHA) regulations. For example, during any procedure involving tire inflation, the technician or individual must utilize a remote inflation device, and ensure that all persons are clear of the trajectory area.

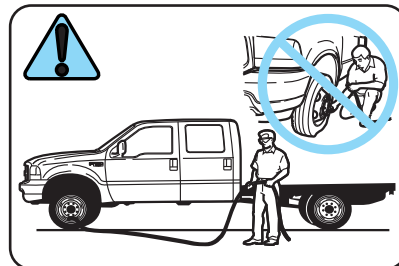

! **WARNING:** An inflated tire and rim can be very dangerous if improperly used, serviced or maintained. To reduce the risk of serious injury, never attempt to re-inflate a tire which has been run flat or seriously under-inflated without first removing the tire from the wheel assembly for inspection. Do not attempt to add air to tires or replace tires or wheels without first taking precautions to protect persons and property.

Tires, Wheels and Loading

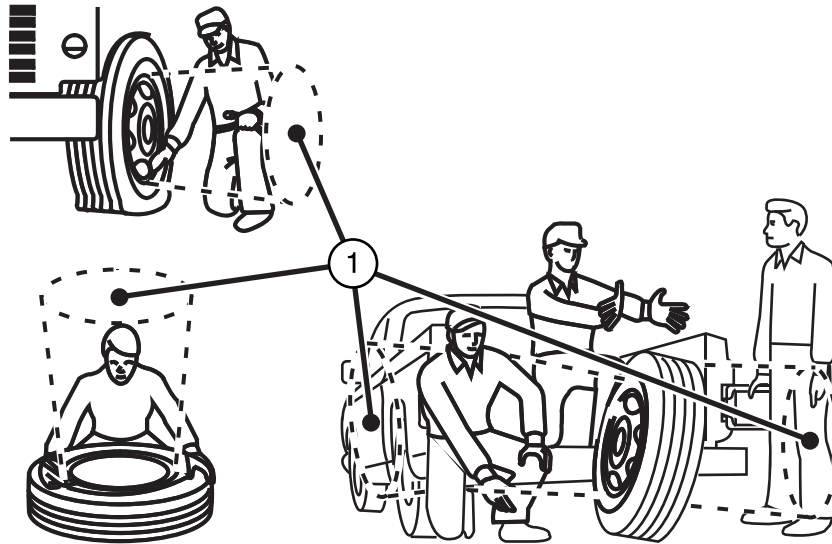

WARNING: Stay out of the trajectory (1) as indicated in the illustration.

TIRE CARE

Inspecting your tires and wheel valve stems

Periodically inspect the tire treads for uneven or excessive wear and remove objects such as stones, nails or glass that may be wedged in the tread grooves. Check the tire and valve stems for holes, cracks, or cuts that may permit air leakage and repair or replace the tire and replace the valve stem. Inspect the tire sidewalls for cracking, cuts, bruises and other signs of damage or excessive wear. If internal damage to the tire is suspected, have the tire demounted and inspected in case it needs to be repaired or replaced. For your safety, tires that are damaged or show signs of excessive wear should not be used because they are more likely to blow out or fail.

Tires, Wheels and Loading

Improper or inadequate vehicle maintenance can cause tires to wear abnormally. Inspect all your tires, including the spare, frequently, and replace them if one or more of the following conditions exist:

Tire wear

When the tread is worn down to 1/16th of an inch (2 mm), tires must be replaced to help prevent your vehicle from skidding and hydroplaning. Built-in treadwear indicators, or “wear bars”, which look like narrow strips of smooth rubber across the tread will appear on the tire when the tread is worn down to 1/16th of an inch (2 mm).

When the tire tread wears down to the same height as these “wear bars”, the tire is worn out and must be replaced.

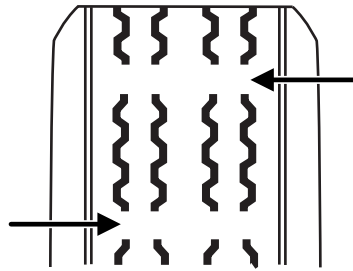

Damage

Periodically inspect the tire treads and sidewalls for damage (such as bulges in the tread or sidewalls, cracks in the tread groove and separation in the tread or sidewall). If damage is observed or suspected have the tire inspected by a tire professional. Tires can be damaged during off-road use, so inspection after off-road use is also recommended.



WARNING: Age

Tires degrade over time depending on many factors such as weather, storage conditions, and conditions of use (load, speed, inflation pressure, etc.) the tires experience throughout their lives. In general, tires should be replaced after six years regardless of tread wear. However, heat caused by hot climates or frequent high loading conditions can accelerate the aging process and may require tires to be replaced more frequently.

You should replace your spare tire when you replace the road tires or after six years due to aging even if it has not been used.

Tires, Wheels and Loading

U.S. DOT Tire Identification Number (TIN)

Both U.S. and Canada Federal regulations require tire manufacturers to place standardized information on the sidewall of all tires. This information identifies and describes the fundamental characteristics of the tire and also provides a U.S. DOT Tire Identification Number for safety standard certification and in case of a recall.

This begins with the letters "DOT" and indicates that the tire meets all federal standards. The next two numbers or letters are the plant code designating where it was manufactured, the next two are the tire size code and the last four numbers represent the week and year the tire was built. For example, the numbers 317 mean the 31st week of 1997. After 2000 the numbers go to four digits. For example, 2501 means the 25th week of 2001. The numbers in between are identification codes used for traceability. This information is used to contact customers if a tire defect requires a recall.

Tire replacement requirements

Your vehicle is equipped with tires designed to provide a safe ride and handling capability.



WARNING: Only use replacement tires and wheels that are the same size, load index, speed rating and type (such as P-metric versus LT-metric or all-season versus all-terrain) as those originally provided by Ford. The recommended tire and wheel size may be found on either the Safety Compliance Certification Label or the Tire Label which is located on the B-Pillar or edge of the driver's door. If this information is not found on these labels then you should contact your authorized dealer as soon as possible. Use of any tire or wheel not recommended by Ford can affect the safety and performance of your vehicle, which could result in an increased risk of loss of vehicle control, vehicle rollover, personal injury and death. Additionally the use of non-recommended tires and wheels could cause steering, suspension, axle or transfer case/power transfer unit failure. If you have questions regarding tire replacement, contact your authorized dealer as soon as possible.

Tires, Wheels and Loading



WARNING: When mounting replacement tires and wheels, you should not exceed the maximum pressure indicated on the sidewall of the tire to set the beads without additional precautions listed below. If the beads do not seat at the maximum pressure indicated, re-lubricate and try again.

When inflating the tire for mounting pressures up to 20 psi (138 kPa) greater than the maximum pressure on the tire sidewall, the following precautions must be taken to protect the person mounting the tire:

1. Make sure that you have the correct tire and wheel size.
2. Lubricate the tire bead and wheel bead seat area again.
3. Stand at a minimum of 12 ft (3.66 m) away from the tire wheel assembly.
4. Use both eye and ear protection.

For a mounting pressure more than 20 psi (138 kPa) greater than the maximum pressure, an authorized dealer or other tire service professional should do the mounting.

Always inflate steel carcass tires with a remote air fill with the person inflating standing at a minimum of 12 ft (3.66 m) away from the tire wheel assembly.

Important: Remember to replace the wheel valve stems when the road tires are replaced on your vehicle.

It is recommended that the two front tires or two rear tires generally be replaced as a pair.

The tire pressure sensors mounted in the wheels are not designed to be used in aftermarket wheels.

The use of wheels or tires not recommended by Ford Motor Company may affect the operation of your tire pressure monitoring system (if equipped).

If the TPMS indicator is flashing, your TPMS is malfunctioning. Your replacement tire might be incompatible with your TPMS, or some component of the TPMS may be damaged (if equipped).

Safety practices

Driving habits have a great deal to do with your tire mileage and safety.

- Observe posted speed limits
- Avoid fast starts, stops and turns
- Avoid potholes and objects on the road

Tires, Wheels and Loading

- Do not run over curbs or hit the tire against a curb when parking



WARNING: If your vehicle is stuck in snow, mud, sand, etc., **do not** rapidly spin the tires; spinning the tires can tear the tire and cause an explosion. A tire can explode in as little as three to five seconds.



WARNING: Do not spin the wheels at over 35 mph (56 km/h). The tires may fail and injure a passenger or bystander.

Highway hazards

No matter how carefully you drive there's always the possibility that you may eventually have a flat tire on the highway. Drive slowly to the closest safe area out of traffic. This may further damage the flat tire, but your safety is more important.

If you feel a sudden vibration or ride disturbance while driving, or you suspect your tire or vehicle has been damaged, immediately reduce your speed. Drive with caution until you can safely pull off the road. Stop and inspect the tires for damage. If a tire is under-inflated or damaged, deflate it, remove wheel and replace it with your spare tire and wheel. If you cannot detect a cause, have the vehicle towed to the nearest repair facility or tire dealer to have the vehicle inspected.

Tire and wheel alignment

A bad jolt from hitting a curb or pothole can cause the front end of your vehicle to become misaligned or cause damage to your tires. If your vehicle seems to pull to one side when you're driving, the wheels may be out of alignment. Have an authorized dealer check the wheel alignment periodically.

Wheel misalignment in the front or the rear can cause uneven and rapid treadwear of your tires and should be corrected by an authorized dealer. Front-wheel drive (FWD) vehicles and those with an independent rear suspension (if equipped) may require alignment of all four wheels.

The tires should also be balanced periodically. An unbalanced tire and wheel assembly may result in irregular tire wear.

Tires, Wheels and Loading

Tire rotation

Rotating your tires at the recommended interval (as indicated in the *Scheduled Maintenance Guide* chapter) will help your tires wear more evenly, providing better tire performance and longer tire life.

- Rear-wheel drive (RWD) vehicles/Four-wheel drive (4WD)/All-wheel drive (AWD) vehicles (front tires at top of diagram)

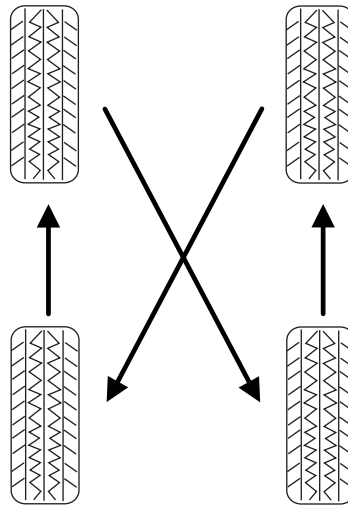

Sometimes irregular tire wear can be corrected by rotating the tires.

Note: If your tires show uneven wear ask an authorized dealer to check for and correct any wheel misalignment, tire imbalance or mechanical problem involved before tire rotation.

Note: Your vehicle may be equipped with a dissimilar spare tire/wheel. A dissimilar spare tire/wheel is defined as a spare tire and/or wheel that is different in brand, size or appearance from the road tires and wheels. If you have a dissimilar spare tire/wheel it is intended for temporary use only and should not be used in a tire rotation.

Note: After having your tires rotated, inflation pressure must be checked and adjusted to the vehicle requirements.

Tires, Wheels and Loading

⚠ WARNING: If the tire label shows different tire pressures for the front and rear tires and the vehicle is equipped with TPMS (tire pressure monitoring system), then the settings for the TPMS sensors need to be updated. Always perform the TPMS reset procedure after tire rotation. If the system is not reset, it may not provide a low tire pressure warning when necessary. See the TPMS reset procedure in this chapter.

- DRW – Six tire rotation

If your vehicle is equipped with dual rear wheels it is recommended that the front and rear tires (in pairs) be rotated only side to side. We do not recommend splitting up the dual rear wheels. Rotate them side to side as a set/pair. After tire rotation, inflation pressures must be adjusted for the tires new positions in accordance with vehicle requirements.

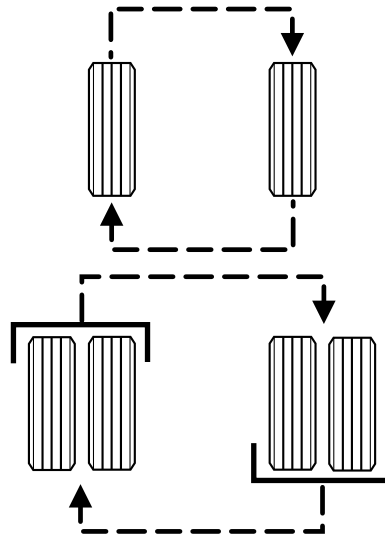

Sometimes irregular tire wear can be corrected by rotating the tires.

Note: If your tires show uneven wear ask your authorized dealer to check for and correct any wheel misalignment, tire imbalance or mechanical problem involved before tire rotation.

Note: Your vehicle may be equipped with a dissimilar spare tire/wheel. A dissimilar spare tire/wheel is defined as a spare tire and/or wheel that is different in brand, size or appearance from the road tires and wheels. If you have a dissimilar spare tire/wheel it is intended for temporary use only and should not be used in a tire rotation.

Note: After having your tires rotated, inflation pressure must be checked and adjusted to the vehicle requirements.

226

Tires, Wheels and Loading

INFORMATION CONTAINED ON THE TIRE SIDEWALL

Both U.S. and Canada Federal regulations require tire manufacturers to place standardized information on the sidewall of all tires. This information identifies and describes the fundamental characteristics of the tire and also provides a U.S. DOT Tire Identification Number for safety standard certification and in case of a recall.

Information on “P” type tires

P215/65R15 95H is an example of a tire size, load index and speed rating. The definitions of these items are listed below. (Note that the tire size, load index and speed rating for your vehicle may be different from this example.)

1. **P:** Indicates a tire, designated by the Tire and Rim Association (T&RA), that may be used for service on cars, SUVs, minivans and light trucks.

Note: If your tire size does not begin with a letter this may mean it is designated by either ETRTO (European Tire and Rim Technical Organization) or JATMA (Japan Tire Manufacturing Association).

2. **215:** Indicates the nominal width of the tire in millimeters from sidewall edge to sidewall edge. In general, the larger the number, the wider the tire.

3. **65:** Indicates the aspect ratio which gives the tire’s ratio of height to width.

4. **R:** Indicates a “radial” type tire.

5. **15:** Indicates the wheel or rim diameter in inches. If you change your wheel size, you will have to purchase new tires to match the new wheel diameter.

6. **95:** Indicates the tire’s load index. It is an index that relates to how much weight a tire can carry. You may find this information in your Owner’s Guide. If not, contact a local tire dealer.

Note: You may not find this information on all tires because it is not required by federal law.

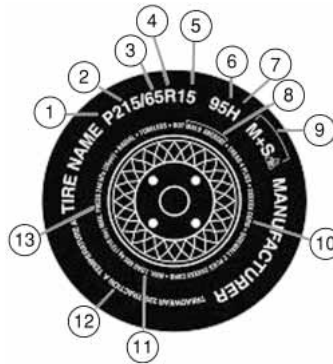

Tires, Wheels and Loading

7. **H:** Indicates the tire's speed rating. The speed rating denotes the speed at which a tire is designed to be driven for extended periods of time under a standard condition of load and inflation pressure. The tires on your vehicle may operate at different conditions for load and inflation pressure. These speed ratings may need to be adjusted for the difference in conditions. The ratings range from 81 mph (130 km/h) to 186 mph (299 km/h). These ratings are listed in the following chart.

Note: You may not find this information on all tires because it is not required by federal law.

Letter rating	Speed rating - mph (km/h)
M	81 mph (130 km/h)
N	87 mph (140 km/h)
Q	99 mph (159 km/h)
R	106 mph (171 km/h)
S	112 mph (180 km/h)
T	118 mph (190 km/h)
U	124 mph (200 km/h)
H	130 mph (210 km/h)
V	149 mph (240 km/h)
W	168 mph (270 km/h)
Y	186 mph (299 km/h)

Note: For tires with a maximum speed capability over 149 mph (240 km/h), tire manufacturers sometimes use the letters ZR. For those with a maximum speed capability over 186 mph (299 km/h), tire manufacturers always use the letters ZR.

8. **U.S. DOT Tire Identification Number (TIN):** This begins with the letters "DOT" and indicates that the tire meets all federal standards. The next two numbers or letters are the plant code designating where it was manufactured, the next two are the tire size code and the last four numbers represent the week and year the tire was built. For example, the numbers 317 mean the 31st week of 1997. After 2000 the numbers go to four digits. For example, 2501 means the 25th week of 2001. The numbers in between are identification codes used for traceability. This information is used to contact customers if a tire defect requires a recall.

9. **M+S or M/S:** Mud and Snow, or

AT: All Terrain, or

AS: All Season.

228

Tires, Wheels and Loading

10. **Tire Ply Composition and Material Used:** Indicates the number of plies or the number of layers of rubber-coated fabric in the tire tread and sidewall. Tire manufacturers also must indicate the ply materials in the tire and the sidewall, which include steel, nylon, polyester, and others.

11. **Maximum Load:** Indicates the maximum load in kilograms and pounds that can be carried by the tire. Refer to the Safety Compliance Certification Label, which is located on the B-Pillar or the edge of the driver's door, for the correct tire pressure for your vehicle.

12. Treadwear, Traction and Temperature Grades

- **Treadwear:** The treadwear grade is a comparative rating based on the wear rate of the tire when tested under controlled conditions on a specified government test course. For example, a tire graded 150 would wear one and one-half (1½) times as well on the government course as a tire graded 100.
- **Traction:** The traction grades, from highest to lowest are AA, A, B, and C. The grades represent the tire's ability to stop on wet pavement as measured under controlled conditions on specified government test surfaces of asphalt and concrete. A tire marked C may have poor traction performance.
- **Temperature:** The temperature grades are A (the highest), B and C, representing the tire's resistance to the generation of heat and its ability to dissipate heat when tested under controlled conditions on a specified indoor laboratory test wheel.

13. **Maximum Permissible Inflation Pressure:** Indicates the tire manufacturers' maximum permissible pressure and/or the pressure at which the maximum load can be carried by the tire. This pressure is normally higher than the manufacturer's recommended cold inflation pressure which can be found on the Safety Compliance Certification Label or Tire Label which is located on the B-Pillar or the edge of the driver's door. The cold inflation pressure should never be set lower than the recommended pressure on the vehicle label.

The tire suppliers may have additional markings, notes or warnings such as standard load, radial tubeless, etc.

Tires, Wheels and Loading

Additional information contained on the tire sidewall for “LT” type tires

“LT” type tires have some additional information beyond those of “P” type tires; these differences are described below.

Note: Tire Quality Grades do not apply to this type of tire.

1. **LT:** Indicates a tire, designated by the Tire and Rim Association (T&RA), that is intended for service on light trucks.

2. Load Range/Load Inflation

Limits: Indicates the tire’s load-carrying capabilities and its inflation limits.

3. **Maximum Load Dual lb (kg) at psi (kPa) cold:** Indicates the maximum load and tire pressure when the tire is used as a dual; defined as four tires on the rear axle (a total of six or more tires on the vehicle).

4. **Maximum Load Single lb (kg) at psi (kPa) cold:** Indicates the maximum load and tire pressure when the tire is used as a single; defined as two tires (total) on the rear axle.

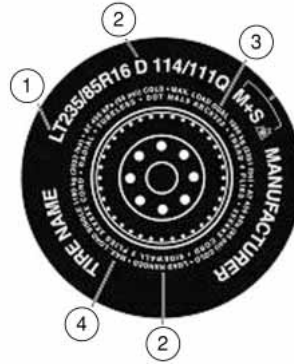

Tires, Wheels and Loading

Information on “T” type tires

“T” type tires have some additional information beyond those of “P” type tires; these differences are described below:

T145/80D16 is an example of a tire size.

Note: The temporary tire size for your vehicle may be different from this example. Tire Quality Grades do not apply to this type of tire.

1. **T:** Indicates a type of tire, designated by the Tire and Rim Association (T&RA), that is intended for temporary service on cars, SUVs, minivans and light trucks.

2. **145:** Indicates the nominal width of the tire in millimeters from sidewall edge to sidewall edge. In general, the larger the number, the wider the tire.

3. **80:** Indicates the aspect ratio which gives the tire’s ratio of height to width. Numbers of 70 or lower indicate a short sidewall.

4. **D:** Indicates a “diagonal” type tire.

R: Indicates a “radial” type tire.

5. **16:** Indicates the wheel or rim diameter in inches. If you change your wheel size, you will have to purchase new tires to match the new wheel diameter.

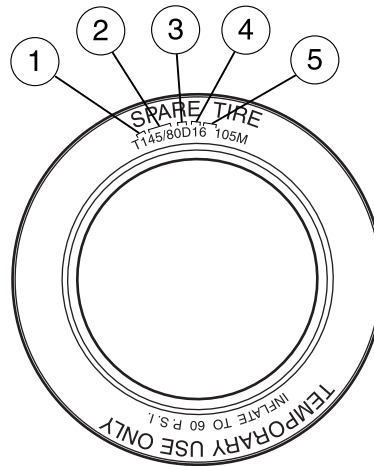

Location of the tire label

You will find a Tire Label containing tire inflation pressure by tire size and other important information located on the B-Pillar or the edge of the driver’s door. Refer to the payload description and graphic in the *Vehicle loading — with and without a trailer* section.

Tires, Wheels and Loading

TIRE PRESSURE MONITORING SYSTEM (TPMS) (IF EQUIPPED)

Each tire, including the spare (if provided), should be checked monthly when cold and inflated to the inflation pressure recommended by the vehicle manufacturer on the vehicle placard or tire inflation pressure label. (If your vehicle has tires of a different size than the size indicated on the vehicle placard or tire inflation pressure label, you should determine the proper tire inflation pressure for those tires.)

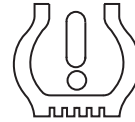

As an added safety feature, your vehicle has been equipped with a tire pressure monitoring system (TPMS) that illuminates a low tire pressure telltale when one or more of your tires is significantly under-inflated. Accordingly, when the low tire pressure telltale illuminates, you should stop and check your tires as soon as possible, and inflate them to the proper pressure. Driving on a significantly under-inflated tire causes the tire to overheat and can lead to tire failure. Under-inflation also reduces fuel efficiency and tire tread life, and may affect the vehicle's handling and stopping ability.

Please note that the TPMS is not a substitute for proper tire maintenance, and it is the driver's responsibility to maintain correct tire pressure, even if under-inflation has not reached the level to trigger illumination of the TPMS low tire pressure telltale.

Your vehicle has also been equipped with a TPMS malfunction indicator to indicate when the system is not operating properly. The TPMS malfunction indicator is combined with the low tire pressure telltale. When the system detects a malfunction, the telltale will flash for approximately one minute and then remain continuously illuminated. This sequence will continue upon subsequent vehicle start-ups as long as the malfunction exists.

When the malfunction indicator is illuminated, the system may not be able to detect or signal low tire pressure as intended. TPMS malfunctions may occur for a variety of reasons, including the installation of replacement or alternate tires or wheels on the vehicle that prevent the TPMS from functioning properly. Always check the TPMS malfunction telltale after replacing one or more tires or wheels on your vehicle to ensure that the replacement or alternate tires and wheels allow the TPMS to continue to function properly.

The tire pressure monitoring system complies with part 15 of the FCC rules and with RSS-210 of Industry Canada. Operation is subject to the

232

Tires, Wheels and Loading

following two conditions: (1) This device may not cause harmful interference, and (2) This device must accept any interference received, including interference that may cause undesired operation.



WARNING: The tire pressure monitoring system is NOT a substitute for manually checking tire pressure. The tire pressure should be checked periodically (at least monthly) using a tire gauge, see *Inflating your tires* in this chapter. Failure to properly maintain your tire pressure could increase the risk of tire failure, loss of control, vehicle rollover and personal injury.

Changing tires with TPMS

Each road tire is equipped with a tire pressure sensor located inside the tire/wheel cavity. The pressure sensor is attached to the valve stem. The pressure sensor is covered by the tire and is not visible unless the tire is removed.

Care must be taken when changing the tire to avoid damaging the sensor.

It is recommended that you always have your tires serviced by an authorized dealer.

The tire pressure should be checked periodically (at least monthly) using an accurate tire gauge, refer to *Inflating your tires* in this chapter.

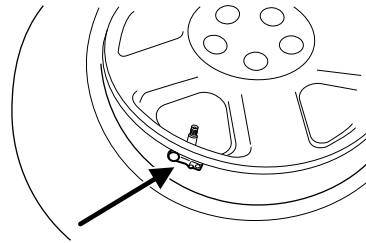

Understanding your tire pressure monitoring system (TPMS)

The tire pressure monitoring system measures pressure in your four road tires and sends the tire pressure readings to your vehicle. The low tire warning lamp will turn on if the tire pressure is significantly low. Once the light is illuminated, your tires are under inflated and need to be inflated to the manufacturer's recommended tire pressure. Even if the light turns on and a short time later turns off, your tire pressure still needs to be checked. Visit www.checkmytires.org for additional information.

When your temporary spare tire is installed

When one of your road tires needs to be replaced with the temporary spare, the TPMS system will continue to identify an issue to remind you that the damaged road wheel/tire needs to be repaired and put back on your vehicle.

To restore the full functionality of the tire pressure monitoring system, have the damaged road wheel/tire repaired and remounted on your vehicle. For additional information, refer to *Changing tires with TPMS* in this section.

Tires, Wheels and Loading

When you believe your system is not operating properly

The main function of the tire pressure monitoring system is to warn you when your tires need air. It can also warn you in the event the system is no longer capable of functioning as intended. Please refer to the following chart for information concerning your tire pressure monitoring system:

Low tire pressure warning light	Possible cause	Customer action required
Solid warning light	Tire(s) under-inflated	1. Check your tire pressure to ensure tires are properly inflated; refer to <i>Inflating your tires</i> in this chapter. 2. After inflating your tires to the manufacturer's recommended inflation pressure as shown on the Tire Label (located on the edge of driver's door or the B-Pillar), the vehicle must be driven for at least two minutes over 20 mph (32 km/h) before the light will turn off.
	Spare tire in use	Your temporary spare tire is in use. Repair the damaged road wheel/tire and reinstall it on the vehicle to restore system functionality. For a description on how the system functions, refer to <i>When your temporary spare tire is installed</i> in this section.
	TPMS malfunction	If your tires are properly inflated and your spare tire is not in use and the light remains on, have the system inspected by your authorized dealer.
	Tire rotation without sensor training	On vehicles with different front and rear tire pressures, the TPMS system must be retrained following every tire rotation. Refer to <i>Tire rotation</i> in this chapter.

Tires, Wheels and Loading

Low tire pressure warning light	Possible cause	Customer action required
Flashing warning light	Spare tire in use	Your temporary spare tire is in use. Repair the damaged road wheel and re-mount it on the vehicle to restore system functionality. For a description of how the system functions under these conditions, refer to <i>When your temporary spare tire is installed</i> in this section.
	TPMS malfunction	If your tires are properly inflated and your spare tire is not in use and the TPMS warning light still flashes, have the system inspected by your authorized dealer.

When inflating your tires

When putting air into your tires (such as at a gas station or in your garage), the tire pressure monitoring system may not respond immediately to the air added to your tires.

It may take up to two minutes of driving over 20 mph (32 km/h) for the light to turn off after you have filled your tires to the recommended inflation pressure.

How temperature affects your tire pressure

The tire pressure monitoring system (TPMS) monitors tire pressure in each pneumatic tire. While driving in a normal manner, a typical passenger tire inflation pressure may increase approximately 2 to 4 psi (14 to 28 kPa) from a cold start situation. If the vehicle is stationary over night with the outside temperature significantly lower than the daytime temperature, the tire pressure may decrease approximately 3 psi (21 kPa) for a drop of 30°F (17°C) in ambient temperature. This lower pressure value may be detected by the TPMS as being significantly lower than the recommended inflation pressure and activate the TPMS warning for low tire pressure. If the low tire pressure warning light is on, visually check each tire to verify that no tire is flat. (If one or more tires are flat, repair as necessary.) Check air pressure in the road tires. If any tire is under-inflated, carefully drive the vehicle to the nearest location where air can be added to the tires. Inflate all the tires to the recommended inflation pressure.

Tires, Wheels and Loading

TPMS reset procedure

The TPMS reset procedure needs to be performed after each tire rotation on vehicles that require different recommended tire pressures in the front tires as compared to the rear tires.



WARNING: To determine the required pressure(s) for your vehicle – refer to the Safety Compliance Certification Label or Tire Label located on the B-Pillar or the edge of the driver's door. See *Vehicle loading - with and without a trailer* in this chapter for more information.

Overview

To provide the vehicle's load carrying capability, some vehicles require different recommended tire pressures in the front tires as compared to the rear tires. The tire pressure monitoring system (TPMS) equipped on these vehicles is designed to illuminate the Low Tire Pressure Warning indicator at two different pressures; one for the front tires and one for the rear tires.

Since tires need to be rotated to provide consistent performance and maximum tire life, the tire pressure monitoring system needs to know when the tires are rotated to determine which set of tires are on the front and which are on the rear. With this information, the system can detect and properly warn of low tire pressures.

TPMS reset tips:

- To reduce the chances of interference from another vehicle, the TPMS reset procedure should be performed at least 3 feet (1 meter) away from another Ford Motor Company vehicle undergoing the TPMS reset procedure at the same time.
- Do not wait more than two minutes between resetting each tire sensor or the system will timeout and the entire procedure will have to be repeated on all four wheels.
- A double horn chirp indicates the need to repeat the procedure.

Performing the TPMS reset procedure

It is recommended that you read the entire procedure before attempting.

1. Drive the vehicle above 20 mph (32 km/h) for at least two minutes and then park in a safe location where you can easily get to all four tires and have access to an air pump.
2. Place the ignition in the off position and keep the key in the ignition.

236

Tires, Wheels and Loading

3. Cycle the ignition to the on position with the engine off.

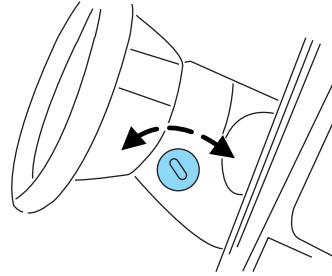

4. Turn the hazard flashers on then off three times. This must be accomplished within 10 seconds.



If the reset mode has been entered successfully, the horn will sound once, the TPMS indicator (⚠) will flash and the message center (if equipped) will display **TRAIN LEFT FRONT TIRE**. If this does not occur, please try again starting at Step 2.

If after repeated attempts to enter the reset mode, the horn does not sound, the TPMS indicator (⚠) does not flash and the message center (if equipped) does not display **TRAIN LEFT FRONT TIRE**, seek service from your authorized dealer.

5. Train the TPMS sensors in the tires using the following TPMS reset sequence starting with the **left front tire** in the following clockwise order:

- Left front (Driver's side front tire)
- Right front (Passenger's side front tire)
- Right rear (Passenger's side rear tire)
- Left rear (Driver's side rear tire)

6. Remove the valve cap from the valve stem on the left front tire. Decrease the air pressure until the horn sounds.

Note: The single horn chirp confirms that the sensor identification code has been learned by the module for this position. If a double horn is heard, the reset procedure was unsuccessful, and must be repeated.

7. Remove the valve cap from the valve stem on the right front tire. Decrease the air pressure until the horn sounds.

Tires, Wheels and Loading

8. Remove the valve cap from the valve stem on the right rear tire. Decrease the air pressure until the horn sounds.

9. Remove the valve cap from the valve stem on the left rear tire. Decrease the air pressure until the horn sounds.

Training is complete after the horn sounds for the last tire trained (driver's side rear tire), the TPMS tell tale stops flashing, and the message center displays:

TRAINING COMPLETE.

10. Turn the ignition off. If two short horn beeps are heard, the reset procedure was unsuccessful and must be repeated.

If after repeating the procedure and two short beeps are heard when the ignition is turned to off, seek assistance from your authorized dealer.

11. Set all four tires to the recommended air pressure as indicated on the Safety Compliance Certification Label or Tire Label located on the B-Pillar or the edge of the driver's door. See *Vehicle loading - with and without a trailer* in this chapter for more information.

SNOW TIRES AND CHAINS



WARNING: Snow tires must be the same size, load index, speed rating as those originally provided by Ford. Use of any tire or wheel not recommended by Ford can affect the safety and performance of your vehicle, which could result in an increased risk of loss of vehicle control, vehicle rollover, personal injury and death. Additionally, the use of non-recommended tires and wheels could cause steering, suspension, axle or transfer case/power transfer unit failure.

Note: Do not use snow chains on vehicles with 20 inch wheels and tires.

The tires on your vehicle have all weather treads to provide traction in rain and snow. However, in some climates, you may need to use snow tires and chains. If you need to use chains, it is recommended that steel wheels (of the same size and specifications) be used, as chains may chip aluminum wheels.

Tires, Wheels and Loading

Follow these guidelines when using snow tires and chains:

- Use only SAE Class S chains.
- Install chains securely, verifying that the chains do not touch any wiring, brake lines or fuel lines.
- Drive cautiously. If you hear the chains rub or bang against your vehicle, stop and re-tighten the chains. If this does not work, remove the chains to prevent damage to your vehicle.
- If possible, avoid fully loading your vehicle.
- Remove the tire chains when they are no longer needed. Do not use tire chains on dry roads.
- The suspension insulation and bumpers will help prevent vehicle damage. Do not remove these components from your vehicle when using snow tires and chains.

VEHICLE LOADING – WITH AND WITHOUT A TRAILER

This section will guide you in the proper loading of your vehicle and/or trailer, to keep your loaded vehicle weight within its design rating capability, with or without a trailer. Properly loading your vehicle will provide maximum return of vehicle design performance. Before loading your vehicle, familiarize yourself with the following terms for determining your vehicle's weight ratings, with or without a trailer, from the vehicle's Tire Label or Safety Compliance Certification Label:

Base Curb Weight – is the weight of the vehicle including a full tank of fuel and all standard equipment. It does not include passengers, cargo, or optional equipment.

Vehicle Curb Weight – is the weight of your new vehicle when you picked it up from your authorized dealer plus any aftermarket equipment.

Tires, Wheels and Loading

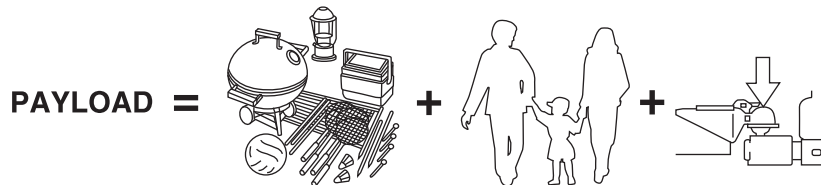

Payload – is the combined weight of cargo and passengers that the vehicle is carrying. The maximum payload for your vehicle can be found on the Tire Label on the B-Pillar or the edge of the driver's door (vehicles exported outside the US and Canada may not have a Tire Label). Look for **“THE COMBINED WEIGHT OF OCCUPANTS AND CARGO SHOULD NEVER EXCEED XXX kg OR XXX lb.”** for maximum payload. The payload listed on the Tire Label is the maximum payload for the vehicle as built by the assembly plant. If any aftermarket or authorized-dealer installed equipment has been installed on the vehicle, the weight of the equipment must be subtracted from the payload listed on the Tire Label in order to determine the new payload.

 **WARNING:** The appropriate loading capacity of your vehicle can be limited either by volume capacity (how much space is available) or by payload capacity (how much weight the vehicle should carry). Once you have reached the maximum payload of your vehicle, do not add more cargo, even if there is space available. Overloading or improperly loading your vehicle can contribute to loss of vehicle control and vehicle rollover.

Tires, Wheels and Loading

Example only:

TIRE AND LOADING INFORMATION			
SEATING CAPACITY		TOTAL 5	FRONT 2 REAR 3
The combined weight of occupants and cargo should never exceed : XXX kg or XXX lbs.			
TIRE	SIZE	COLD TIRE PRESSURE	SEE OWNERS MANUAL FOR ADDITIONAL INFORMATION
FRONT	LT225/75R 16.5E	200 KPA, 29 PSI	
REAR	LT225/75R 16.5E	200 KPA, 29 PSI	
SPARE	T145/80D16 P225/60R17	420 KPA, 60 PSI 200 KPA, 29 PSI	

TIRE AND LOADING INFORMATION			
RENSEIGNEMENTS SUR LES PNEUS ET LE CHARGEMENT			
SEATING CAPACITY		TOTAL 5	FRONT 2 REAR 3
NOMBRE DE PLACES		AVANT 2	ARRIÈRE 3
The combined weight of occupants and cargo should never exceed 492 kg or 1085 lbs.			
Le poids total des occupants et du chargement ne doit jamais dépasser 492 kg ou 1085 lb.			
TIRE PNEU	SIZE DIMENSIONS	COLD TIRE PRESSURE PRESSION DES PNEUS A FROID	SEE OWNER'S MANUAL FOR ADDITIONAL INFORMATION VOIR LE MANUEL DE L'USAGER POUR PLUS DE RENSEIGNEMENTS
FRONT AVANT	P235/70R16	240 KPA, 35 PSI	
REAR ARRIÈRE	P235/70R16	240 KPA, 35 PSI	
SPARE DE SECOURS	T145/90R17	415 KPA, 60 PSI	

CARGO =



+

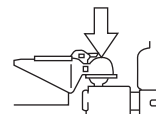

Cargo Weight – includes all weight added to the Base Curb Weight, including cargo and optional equipment. When towing, trailer tongue load or king pin weight is also part of cargo weight.

GAW (Gross Axle Weight) – is the total weight placed on each axle (front and rear) – including vehicle curb weight and all payload.

Tires, Wheels and Loading

GAWR (Gross Axle Weight Rating) – is the maximum allowable weight that can be carried by a single axle (front or rear). **These numbers are shown on the Safety Compliance Certification Label located on the B-Pillar or the edge of the driver's door. The total load on each axle must never exceed its GAWR.**

Note: For trailer towing information refer to *Trailer towing* found in this chapter or the *RV and Trailer Towing Guide* provided by your authorized dealer.

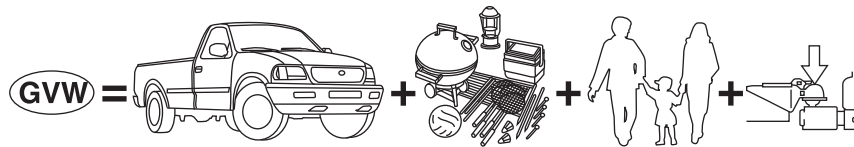

GVW (Gross Vehicle Weight) – is the Vehicle Curb Weight + cargo + passengers.

GVWR (Gross Vehicle Weight Rating) – is the maximum allowable weight of the fully loaded vehicle (including all options, equipment, passengers and cargo). **The GVWR is shown on the Safety Compliance Certification Label located on the B-Pillar or the edge of the driver's door. The GVW must never exceed the GVWR.**

Tires, Wheels and Loading

- Example only:

MFD. BY FORD MOTOR CO.

DATE: XX/XX GVWR: XXXXXLB/ XXXXXKG
 FRONT GAWR: XXXXL WITH REAR GAWR: XXXXLB
 XXXXKG WITH XXXXKG WITH
 XXXX/XXXXXXX TIRES: XXXX/XXXXXXX TIRES
 XXXX,XX RIMS: XXXX,XX RIMS
 AT XXX kPa/XX PSI COLD AT XXX kPa/XX PSI COLD

THIS VEHICLE CONFORMS TO ALL APPLICABLE FEDERAL MOTOR
 VEHICLE SAFETY AND THEFT PREVENTION STANDARDS IN
 EFFECT ON THE DATE OF MANUFACTURE SHOWN ABOVE.

VIN: XXXXXXXXXXXXXXXXXX XXXXX
 TYPE: XXX XXXXX



EXT PNT: XX RC: XX DSO:
 WB BRK INT TR TP/PS R AXLE TR SPR XXXX
 XXX X XX X XX X XX XXX
 XXXXXXXXXXXXX XXX XXXX-XXXXXX-XX

MFD. BY FORD MOTOR CO.

DATE: xx/xx GVWR/PNBV: xxxxx LB/xxxxx KG
 FRONT GAWR/PNBE AV / REAR GAWR/ PNBE AR
 xxxxx /xxxxxB / xxxxx KG/xxxxxB
 WITH/AVEC TIRES/PNEUS
 xxxxx /xxxxx
 xxxxx /xxxxx
 xxx,xxx RIMS/JANTES xxx,xxx

AT/A kPa/PSI/LPC xxx/xx COLD/A FROID xxx/xx
 /JUMEELES

VIN: xxxxxxxxxxxxxxxxxxxx xxxxxx
 TYPE: xxx/xxxxx COMPLIES: xxxxx/xxxx - xxx xxxxxx
 xxxxxx



EXT PNT: JJ RC: xx DSO:
 WB INT TR TP/PS R AXLE TR SPR xxxxx
 xxx xx x xx x xxxxx xxx
 XXXXXXXXXXXXXXX XXX XXXX-XXXXXX-XX

 **WARNING:** Exceeding the Safety Compliance Certification Label vehicle weight rating limits could result in substandard vehicle handling or performance, engine, transmission and/or structural damage, serious damage to the vehicle, loss of control and personal injury.

Tires, Wheels and Loading



GCW (Gross Combined Weight) – is the weight of the loaded vehicle (GVW) plus the weight of the fully loaded trailer.

GCWR (Gross Combined Weight Rating) – is the maximum allowable weight of the vehicle and the loaded trailer – including all cargo and passengers – that the vehicle can handle without risking damage. (Important: The towing vehicle's braking system is rated for operation at GVWR, not at GCWR.) Separate functional brakes should be used for safe control of towed vehicles and for trailers where the GCW of the towing vehicle plus the trailer exceed the GVWR of the towing vehicle. **The GCW must never exceed the GCWR.**

Maximum Loaded Trailer Weight – is the highest possible weight of a fully loaded trailer the vehicle can tow. It assumes a vehicle with only mandatory options, no cargo (internal or external), a tongue load of 10–15% (conventional trailer) or king pin weight of 15–25% (fifth wheel trailer), and driver only (150 lb. [68 kg]). **Consult your authorized dealer (or the *RV and Trailer Towing Guide* provided by your authorized dealer) for more detailed information.**

Tongue Load or Fifth Wheel King Pin Weight – refers to the amount of the weight that a trailer pushes down on a trailer hitch.

Examples: For a 5,000 lb. (2,268 kg) conventional trailer, multiply 5,000 by 0.10 and 0.15 to obtain a proper tongue load range of 500 to 750 lb. (227 to 340 kg). For an 11,500 lb. (5,216 kg) fifth wheel trailer, multiply by 0.15 and 0.25 to obtain a proper king pin load range of 1,725 to 2,875 lb. (782 to 1,304 kg)



WARNING: Do not exceed the GVWR or the GAWR specified on the Safety Compliance Certification Label.

Tires, Wheels and Loading



WARNING: Do not use replacement tires with lower load carrying capacities than the original tires because they may lower the vehicle's GVWR and GAWR limitations. Replacement tires with a higher limit than the original tires do not increase the GVWR and GAWR limitations.



WARNING: Exceeding any vehicle weight rating limitation could result in serious damage to the vehicle and/or personal injury.

Steps for determining the correct load limit:

1. Locate the statement "The combined weight of occupants and cargo should never exceed XXX kg or XXX lb." on your vehicle's placard.
2. Determine the combined weight of the driver and passengers that will be riding in your vehicle.
3. Subtract the combined weight of the driver and passengers from XXX kg or XXX lb.
4. The resulting figure equals the available amount of cargo and luggage load capacity. For example, if the "XXX" amount equals 1,400 lb. and there will be five 150 lb. passengers in your vehicle, the amount of available cargo and luggage load capacity is 650 lb. ($1400 - 750 (5 \times 150) = 650$ lb.). In metric units ($635 - 340 (5 \times 68) = 295$ kg.)
5. Determine the combined weight of luggage and cargo being loaded on the vehicle. That weight may not safely exceed the available cargo and luggage load capacity calculated in Step 4.
6. If your vehicle will be towing a trailer, load from your trailer will be transferred to your vehicle. Consult this manual to determine how this reduces the available cargo and luggage load capacity of your vehicle.

The following gives you a few examples on how to calculate the available amount of cargo and luggage load capacity:

- Another example for your vehicle with 1,400 lb. (635 kg) of cargo and luggage capacity. You decide to go golfing. Is there enough load capacity to carry you, 4 of your friends and all the golf bags? You and four friends average 220 lb. (99 kg) each and the golf bags weigh approximately 30 lb. (13.5 kg) each. The calculation would be: $1400 - (5 \times 220) - (5 \times 30) = 1400 - 1100 - 150 = 150$ lb. Yes, you have enough load capacity in your vehicle to transport four friends and your golf bags. In metric units, the calculation would be: $635 \text{ kg} - (5 \times 99 \text{ kg}) - (5 \times 13.5 \text{ kg}) = 635 - 495 - 67.5 = 72.5$ kg.

Tires, Wheels and Loading

- A final example for your vehicle with 1,400 lb. (635 kg) of cargo and luggage capacity. You and one of your friends decide to pick up cement from the local home improvement store to finish that patio you have been planning for the past 2 years. Measuring the inside of the vehicle with the rear seat folded down, you have room for 12-100 lb. (45 kg) bags of cement. Do you have enough load capacity to transport the cement to your home? If you and your friend each weigh 220 lb. (99 kg), the calculation would be: $1400 - (2 \times 220) - (12 \times 100) = 1400 - 440 - 1200 = -240$ lb. No, you do not have enough cargo capacity to carry that much weight. In metric units, the calculation would be: $635 \text{ kg} - (2 \times 99 \text{ kg}) - (12 \times 45 \text{ kg}) = 635 - 198 - 540 = -103$ kg. You will need to reduce the load weight by at least 240 lb. (104 kg). If you remove 3-100 lb. (45 kg) cement bags, then the load calculation would be:

$1400 - (2 \times 220) - (9 \times 100) = 1400 - 440 - 900 = 60$ lb. Now you have the load capacity to transport the cement and your friend home. In metric units, the calculation would be: $635 \text{ kg} - (2 \times 99 \text{ kg}) - (9 \times 45 \text{ kg}) = 635 - 198 - 405 = 32$ kg.

The above calculations also assume that the loads are positioned in your vehicle in a manner that does not overload the Front or the Rear Gross Axle Weight Rating specified for your vehicle on the Safety Compliance Certification Label found on the edge of the driver's door.

Special loading instructions for owners of pick-up trucks and utility-type vehicles



WARNING: For important information regarding safe operation of this type of vehicle, see the *Preparing to drive your vehicle* section in the *Driving* chapter of this Owner's Guide.



WARNING: Loaded vehicles may handle differently than unloaded vehicles. Extra precautions, such as slower speeds and increased stopping distance, should be taken when driving a heavily loaded vehicle.

Your vehicle can haul more cargo and people than most passenger cars. Depending upon the type and placement of the load, hauling cargo and people may raise the center of gravity of the vehicle.

Tires, Wheels and Loading

TRAILER TOWING

Note: The trailer towing chart in this section applies to vehicles equipped with a gasoline engine; for vehicles equipped with a diesel engine, refer to your diesel supplement.

Your vehicle may tow a Conventional/Class IV trailer or fifth-wheel trailer provided the maximum trailer weight is less than or equal to the maximum trailer weight for your engine and rear axle ratio.

To find the maximum trailer weight allowed for your vehicle, consult your authorized dealer (or the *RV and Trailer Towing Guide* provided by your authorized dealer). To calculate your maximum trailer weight on your own:

For pick-up trucks: Take curb weight, hitch hardware and the driver's weight, then subtract them from the GCWR listed for your vehicle series, engine, transmission and drive axle ratio (*refer to the chart/table in the following text*). This calculation will give you the maximum trailer weight possible for your vehicle.

For chassis cabs and pick-up trucks with aftermarket equipment:

Weigh your vehicle at a certified scale and subtract this actual curb weight, hitch hardware, and the driver's weight from the GCWR listed for your vehicle series, engine, transmission and drive axle ratio (*refer to the chart/table in the following text*). This calculation will give you the maximum trailer weight possible for your vehicle.

The weight of all additional cargo and passengers must be subtracted from the maximum trailer weight calculated above.

Further trailer/hitch restrictions and limitations exist depending on the type of trailer and hitch used. These additional maximum trailer weight and tongue load limitations are listed in the chart/table that follows the listing of GCWRs.

Towing a trailer places an additional load on your vehicle's engine, transmission, axle, brakes, tires and suspension. Inspect these components carefully prior to and after any towing operation. Refer to *Transmission fluid temperature gauge* in the *Instrument Cluster* chapter for the transmission fluid temperature information.

Note: Do not exceed the GCWR listed for your vehicle on the following chart/table, or the GVWR, GAWR or tire ratings specified on the Tire Label or Safety Compliance Certification Label.

Tires, Wheels and Loading

 **WARNING:** Towing trailers beyond the maximum recommended trailer weight which exceeds the limit of the vehicle's GCWR, GVWR, GAWR or tire ratings could result in engine damage, transmission damage, structural damage, loss of vehicle control, vehicle rollover and personal injury.

Vehicle type	Rear axle ratio	Maximum GCWR - lb (kg)
F-250/F-350 Single Rear Wheel (SRW)	3.73	19000 (8617)
	4.30	22000 (9977)
F-350 Dual Rear Wheel (DRW)	3.73	19500 (8844)
	4.30	22500 (10204)
F-450/550	4.88	26000 (11791)

Preparing to tow

Use the proper equipment for towing a trailer and make sure it is properly attached to your vehicle. Contact your authorized dealer or a reliable trailer dealer as soon as possible if you require assistance.

Hitches

 **WARNING:** ON PICK-UP TRUCKS, the trailer hitch provided on this vehicle enhances collision protection for the fuel system. DO NOT REMOVE!

Do not mount a ball hitch (sometimes referred to as a trailer ball hitch or trailer ball) to the bumper or use hitches that clamp onto the vehicle's bumper or attach to the axle. You must distribute the load in your trailer so that 10–15% for conventional towing or 15–25% fifth-wheel towing of the total weight of the trailer is on the tongue.

Hitch rating

The standard hitch has two ratings depending on mode of operation:

- **Weight-carrying** - requires a draw bar and hitch ball. The draw bar supports all the vertical tongue load of the trailer.
- **Weight-distributing** - requires an aftermarket weight-distributing system which includes draw bar, hitch ball, spring bars and snap-up brackets. The vertical tongue load of the trailer is distributed between the truck and the trailer by this system.

248

Tires, Wheels and Loading

- To determine which trailer hitch your vehicle is equipped with, refer to the trailer hitch label located on trailer hitch cross tube. Once you determine which trailer hitch you have consult your authorized dealer (or the *RV and Trailer Towing Guide* provided by your dealer) or online at https://www.fleet.ford.com/showroom/rv_trailer_towing/default.asp.



WARNING: The hitch rating listed on the trailer hitch label are maximum possible trailer ratings for that hitch but may not be what your vehicle is capable of towing. To find the maximum trailer weight allowed for your specific vehicle, consult your authorized dealer (or the *RV and Trailer Towing Guide* provided by your authorized dealer).



WARNING: Towing trailers beyond the maximum tongue weight exceeds the limit of the towing system and could result in vehicle structural damage, loss of vehicle control and personal injury.

Weight-distributing hitch

When hooking-up a trailer using a weight-distributing hitch, always use the following procedure:

1. Park the vehicle (without the trailer) on a level surface.
2. Measure the height of the top of the front wheel opening on the fender, this is H1.
3. Attach the trailer to the vehicle without the weight distributing bars connected.
4. Measure the height of the top of the front wheel opening on the fender a second time, this is H2.
5. Install and adjust the tension in the weight distributing bars so that the height of the front fender is approximately halfway between H1 and H2.
6. Check that the trailer is level. If not level, adjust the ball height accordingly and repeat Steps 3–6.



WARNING: Do not adjust a weight-distributing hitch to any position where the rear bumper of the vehicle is higher than it was before attaching the trailer. Doing so will defeat the function of the weight-distributing hitch, which may cause unpredictable handling, and could result in serious personal injury.

Tires, Wheels and Loading

Fifth-wheel trailer hitch (if equipped)

To find the maximum trailer weight allowed for your vehicle, consult your authorized dealer (or the *RV and Trailer Towing Guide* provided by your authorized dealer).

Fifth-wheel and gooseneck towing

Your vehicle may be equipped with a fifth-wheel prep package. This package enables your vehicle to accept certain fifth-wheel trailer hitches and gooseneck ball hitches. The fifth-wheel trailer hitch is attached to the four mounting pads in the pickup bed; optional 7-pin connector provided in the bed as well. Alternatively, if a gooseneck ball hitch is used, the ball is attached to the tube in the center of the bed.



WARNING: The mounting pads in the bed are specifically designed for certain fifth-wheel trailer hitches and gooseneck ball hitches. Do not use these mounting pads for other purposes. Doing so could result in vehicle structural damage, loss of vehicle control, and personal injury. Contact your authorized dealer to purchase gooseneck and fifth-wheel hitches that are compatible with your vehicle.



WARNING: Towing trailers beyond the maximum limit of the towing system could result in vehicle structural damage, loss of vehicle control and personal injury.

Fifth-wheel and gooseneck hitch ratings



WARNING: The hitch rating listed on the trailer hitch label is the maximum possible trailer rating. To find the maximum trailer weight allowed for your specific vehicle, consult your authorized dealer or the *RV and Trailer Towing Guide* provided by your authorized dealer).

Safety chains

Always connect the trailer's safety chains to the frame or hook retainers of the vehicle hitch. To connect the trailer's safety chains, cross the chains under the trailer tongue and allow slack for turning corners.

If you use a rental trailer, follow the instructions that the rental agency gives to you.

Do not attach safety chains to the bumper.

250

Tires, Wheels and Loading

Trailer brakes

Electric brakes and manual, automatic or surge-type trailer brakes are safe if installed properly and adjusted to the manufacturer's specifications. The trailer brakes must meet local and Federal regulations.



WARNING: If you own a trailer with a hydraulic brake system, do not connect the trailer's hydraulic brake system directly to your vehicle's brake system. The vehicle's brake system is only designed to carry the appropriate amount of brake fluid for the vehicle alone. Connecting a hydraulic trailer braking system could adversely affect your vehicle's braking performance, which could result in loss of vehicle control, crash or serious injury.

The braking system of the tow vehicle is rated for operation at the GVWR not GCWR.

Integrated trailer brake controller (if equipped)

Your vehicle may be equipped with a fully integrated electronic trailer brake controller (TBC). When used properly, the TBC helps ensure smooth and effective trailer braking by powering the trailer's electric brakes with a proportional output based on the towing vehicle's brake pressure.

The Ford TBC has been tested to be compatible with several major brands of electric-over-hydraulic trailer brakes; contact your authorized dealership for information on which brands can be used.



WARNING: The Ford TBC has been verified to be compatible with trailers having electric-actuated drum brakes (one to four axles) and some electric-over-hydraulic types, but not hydraulic surge types. It is the responsibility of the customer to ensure that the trailer brakes are adjusted appropriately, functioning normally and all electric connections are properly made. Failure to do so may result in loss of vehicle control, crash or serious injury.

Tires, Wheels and Loading

The TBC user interface consists of the following:

1. **+/- (GAIN adjustment**

buttons): Pressing these buttons will adjust the TBC's power output to the trailer brakes (in 0.5 increments). The GAIN setting can be increased to a maximum of 10.0 or decreased to a minimum of 0 (no trailer braking). Pressing and holding a button will raise or lower the setting continuously. The gain setting will display in the message center as follows: TBC GAIN = XX.X.

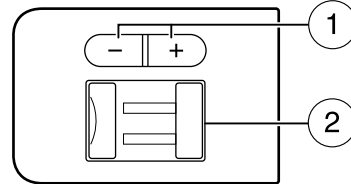

The trailer brake controller (TBC) is designed to display three items of information in the instrument cluster message center. These are: gain setting, output bar graph, and trailer connectivity status. They will appear as follows in the message center.

- **TBC GAIN = XX.X NO TRAILER:** The instrument cluster message center will display the current gain setting during a given ignition cycle and when adjusting the gain. This message is also displayed during manual activation without a trailer connected or when gain adjustments are made with no trailer connected.
- **TBC GAIN = XX.X OUTPUT = /////:** When the vehicle's brake pedal is pushed, or when the manual control is activated, bar indicators will illuminate in the instrument cluster message center to indicate the amount of power going to the trailer brakes relative to the brake pedal or manual control input. One bar indicates the least amount of output with six bars indicating maximum output.
- **TRAILER CONNECTED:** This message is displayed when a correct trailer wiring connection (a trailer with electric trailer brakes) has been sensed during a given ignition cycle.
- **TRAILER DISCONNECTED:** This message is displayed and accompanied by a single chime, when a trailer connection was determined and then a disconnection, either intentionally or unintentionally, has been sensed during a given ignition cycle. It is also displayed if a truck or trailer wiring fault occurs causing the trailer to appear disconnected. This message is also displayed during manual activation without a trailer connected.

Tires, Wheels and Loading

2. **Manual control lever:** Slide the control lever to the left to activate power to the trailer's electric brakes independent of the tow vehicle's brakes (see the following *Procedure for adjusting GAIN* section for instructions on proper use of this feature). If the manual control is activated while the brake is also applied, the greater of the two inputs determines the power sent to the trailer brakes.

- **Stop Lamps:** Activating the TBC manual control lever will illuminate both the trailer brake lamps and the tow vehicle brake lamps except the center high-mount stop lamp (presuming proper trailer electrical connection). Pressing the vehicle brake pedal will also illuminate both trailer and vehicle brake lamps.

Procedure for adjusting GAIN:

The GAIN setting is used to set the TBC for the specific towing condition and should be changed as towing conditions change. Changes to towing conditions include trailer load, vehicle load, road conditions and weather.

The GAIN should be set to provide the maximum trailer braking assistance while ensuring the trailer wheels do not lock when braking. Locked trailer wheels may lead to trailer instability.

Note: This should only be performed in a traffic free environment at speeds of approximately 20–25 mph (30–40 km/h).

1. Make sure the trailer brakes are in good working condition, functioning normally, and properly adjusted. See your trailer dealer if necessary.
2. Hook up the trailer and make the electrical connections according to the trailer manufacturer's instructions.
3. When a trailer with electric brakes is plugged in, the **TRAILER CONNECTED** message will display in the instrument cluster message center.
4. Use the GAIN adjustment (+/-) buttons to increase or decrease the GAIN setting to the desired starting point. A GAIN setting of 6.0 is a good starting point for heavier loads.
5. In a traffic-free environment, tow the trailer on a dry, level surface at a speed of 20–25 mph (30–40 km/h) and squeeze the manual control lever completely.

Tires, Wheels and Loading

6. If the trailer wheels lock-up (indicated by squealing tires), reduce the GAIN setting; if the trailer wheels turn freely, increase the GAIN setting. Repeat Steps 5 and 6 until the GAIN setting is at a point just below trailer wheel lock-up. If towing a heavier trailer, trailer wheel lockup may not be attainable even with the maximum GAIN setting of 10.

Explanation of instrument cluster warning messages:

The TBC interacts with the instrument cluster message center to display the following messages:

TRAILER BRAKE MODULE FAULT: This message is displayed and accompanied by a single chime, in response to faults sensed by the TBC. In the event this message is seen, please contact your authorized dealer as soon as possible for diagnosis and repair. The TBC may still function, but performance may be degraded.

WIRING FAULT ON TRAILER: This message is displayed when a *Short circuit on the electric brake output wire* has occurred. If the **WIRING FAULT ON TRAILER** message is displayed and accompanied by a single chime, with no trailer connected, the problem is with the vehicle wiring from the TBC to the 7-pin connector under the bumper. If the message is only displayed with a trailer connected, the problem is related to the trailer wiring; consult your trailer dealer for assistance. This can be a short to ground (i.e., chaffed wire) or a short to voltage (i.e., pulled pin on trailer emergency break-away battery) or trailer brakes drawing too much current.

Note: Your TBC can be diagnosed by your authorized dealer to determine exactly which trailer fault has occurred; however, if the fault is with the trailer this diagnosis is **not** covered under your Ford warranty.

Points to Remember:

- Remember to adjust gain setting before using the TBC for the first time.
- Readjust GAIN setting on the TBC (according to procedure above) whenever road, weather and trailer or vehicle loading conditions change from those that existed when the gain was initially set.
- The sliding lever on the TBC should be used only for manual activation of trailer brakes to assist with proper adjustment of the GAIN. Misuse, such as application during trailer sway, could cause instability of trailer and/or tow vehicle.
- Avoid towing in adverse weather conditions. The TBC does not provide anti-lock control of the trailer wheels. Trailer wheels can lock-up on slippery surfaces, resulting in reduced stability of trailer and tow vehicle.

254

Tires, Wheels and Loading

- The TBC interacts with the brake system of the vehicle, including ABS, in order to reduce the likelihood of trailer wheel lockup. Therefore, if these systems are not functioning properly the TBC may not function at full performance.
- When the vehicle is turned off, the TBC Output is disabled and the display is shut down. Reactivation of the ignition from off to on will awaken the TBC module.
- The TBC is only a factory or dealer installed item. Ford is not responsible for warranty or performance of the TBC due to misuse or customer installation.
- **Do not attempt removal of the TBC without consulting the *Workshop Manual*. Damage to the unit may result.**

Trailer lamps

Trailer lamps are required on most towed vehicles. Make sure all running lights, brake lights, turn signals and hazard lights are working. Contact your authorized dealer or trailer rental agency for proper instructions and equipment for hooking-up trailer lamps.

Driving while you tow

When towing a trailer:

- Consult your local motor vehicle laws for towing a trailer.
- Do not drive faster than 70 mph (113 km/h) during the first 500 miles (800 km) of trailer towing and don't make full-throttle starts.
- Turn off the speed control. The speed control may shut off automatically when you are towing on long, steep grades.
- Activate the tow/haul feature to eliminate excessive transmission shifting and assist in transmission cooling. For additional information, refer to *Automatic transmission operation* in the *Driving* chapter.
- Allow more distance for stopping with a trailer attached; anticipate stops and brake gradually.
- Your vehicle may be equipped with a temporary or conventional spare tire. If the spare tire is different in size (diameter and/or width), tread type (All-Season or All-Terrain) or is from a different manufacturer other than the road tires on your vehicle, your spare tire is considered "temporary". Consult information on the Tire Label or Safety Compliance Certification Label for limitations when using.

Tires, Wheels and Loading

Servicing after towing

If you tow a trailer for long distances, your vehicle will require more frequent service intervals. Refer to *Special operating conditions* in the *Scheduled Maintenance Guide* chapter.

Trailer towing safety tips

General

- Ensure that the trailer, safety chains and 7-pin electrical connectors are securely fastened.
- Make sure the truck receiver, draw bar, and coupler are properly connected and adjusted.
- Check rear view and side mirrors for proper visibility especially when towing trailer wider than the truck.
- When turning make wide turns to allow trailer tires to properly clear any obstacles.
- When towing, operate the vehicle at lower speeds than you would when not towing a trailer. The likelihood of trailer sway is greater at higher speeds.
- Be prepared for trailer sway due to buffeting when larger vehicles pass in either direction.
- If you will be towing a trailer frequently in hot weather, hilly conditions, at GCWR, or any combination of these factors, consider refilling your rear axle with synthetic gear lubricant if not already so equipped. Refer to *Maintenance product specifications and capacities* in the *Maintenance and Specifications* chapter for the proper axle lubricant. Remember that regardless of the rear axle lubricant used, do not tow a trailer for the first 500 miles (800 km) of a new vehicle, and that the first 500 miles (800 km) of towing be done at no faster than 70 mph (113 km/h) with no full-throttle starts.

Loading

- Trailer loads should be evenly distributed front to back and left to right.
- Never exceed truck, trailer, receiver, ball, tongue, tire or coupler loading recommendations.
- Keep the center-of-gravity low for best handling.

Tires, Wheels and Loading

Braking

- Anticipate the need to stop; allow much more distance and time to stop than normal.
- Do not apply the trailer brakes for extended periods of time as they can overheat and lose effectiveness.
- The trailer brakes must be inspected and serviced at intervals specified by the manufacturer. This includes the shoes, drum and trailer brake magnets.
- Electric brakes also require periodic adjustment to keep the shoes properly spaced. If the brakes get hot when driving or if they will not hold, chances are that they need adjustment.

Backing-up

- Practice backing-up, particularly if you are a novice. Turn the steering wheel to the right to move the trailer's rear end to the right.
- Sharp steering movements may cause the trailer to jackknife or go out of control.

Tires

- Select tires that meet the trailer loading requirements.
- All trailer tires should be of the same size, and construction.
- Always check tow vehicle and trailer tire pressure before towing.

Launching or retrieving a boat

Disconnect the wiring to the trailer before backing the trailer into the water. Reconnect the wiring to the trailer after the trailer is removed from the water.

When backing down a ramp during boat launching or retrieval:

- Do not allow the static water level to rise above the bottom edge of the rear bumper.
- Do not allow waves to break higher than 6 in (15 cm) above the bottom edge of the rear bumper.

Exceeding these limits may allow water to enter vehicle components:

- Causing internal damage to the components.
- Affecting driveability, emissions and reliability.

Replace the rear axle lubricant any time the axle has been submerged in water. Rear axle lubricant quantities are not to be checked or changed unless a leak is suspected or repair required.

Tires, Wheels and Loading

RECREATIONAL TOWING

Follow these guidelines if you have a need for recreational (RV) towing. An example of recreational towing would be towing your vehicle behind a motorhome. These guidelines are designed to ensure that your transmission is not damaged.

Note: Put your climate control system in recirculated air mode to prevent exhaust fumes from entering the vehicle. Refer to the *Climate Controls* chapter for more information.

Drivetrain configuration	Requirements for neutral towing
4x4 with manual-shift transfer case	Transmission in N (Neutral); transfer case in N (Neutral); hublocks set to FREE*
4X2 or 4x4 with electronic-shift transfer case	Do not tow your vehicle with any wheels on the ground, as vehicle or transmission damage may occur. It is recommended to tow your vehicle with all four (4) wheels off the ground such as when using a car-hauling trailer. Otherwise, no recreational towing is permitted.
*Always make sure that both hub locks are set to the same position.	

In case of a roadside emergency with a disabled vehicle, see *Wrecker towing* in the *Roadside Emergencies* chapter.

STARTING

Positions of the ignition

1. Off— shuts off the engine and all accessories/locks the steering wheel and allows key removal.
2. Accessory— allows the electrical accessories such as the radio to operate while the engine is not running. This position also unlocks the steering wheel.
3. On— all electrical circuits operational. Warning lights illuminated. Key position when driving.
4. Start— cranks the engine. Release the key as soon as the engine begins cranking.

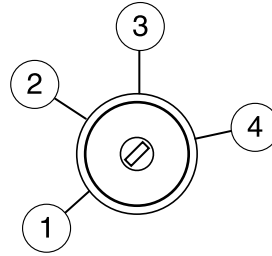

Preparing to start your vehicle

Engine starting is controlled by the powertrain control system.

This system meets all Canadian interference-causing equipment standard requirements regulating the impulse electrical field strength of radio noise.

When starting a fuel-injected engine, don't press the accelerator before or during starting. Only use the accelerator when you have difficulty starting the engine. For more information on starting the vehicle, refer to *Starting the engine* in this chapter.





WARNING: Extended idling at high engine speeds can produce very high temperatures in the engine and exhaust system, creating the risk of fire or other damage.



WARNING: Do not park, idle, or drive your vehicle in dry grass or other dry ground cover. The emission system heats up the engine compartment and exhaust system, which can start a fire.

Driving

 **WARNING:** Do not start your vehicle in a closed garage or in other enclosed areas. Exhaust fumes can be toxic. Always open the garage door before you start the engine. See *Guarding against exhaust fumes* in this chapter for more instructions.

 **WARNING:** If you smell exhaust fumes inside your vehicle, have your dealer inspect your vehicle immediately. Do not drive if you smell exhaust fumes.

Important safety precautions

When the engine starts, the idle RPM runs faster to warm the engine. If the engine idle speed does not slow down automatically, have the vehicle checked. If your vehicle is operated in a heavy snow storm or blowing snow conditions, the engine air induction may become partially clogged with snow and/or ice. If this occurs, the engine may experience a significant reduction in power output. At the earliest opportunity, clear all the snow and/or ice away from the air induction inlet. The following starting instructions are for vehicles equipped with a gasoline engine; if your vehicle is equipped with a diesel engine, refer to *Starting the engine* in your diesel supplement.

Before starting the vehicle:

1. Make sure all occupants buckle their safety belts. For more information on safety belts and their proper usage, refer to the *Seating and Safety Restraints* chapter.
2. Make sure the headlamps and electrical accessories are off.
 - Make sure the parking brake is set.
 - Make sure the gearshift is in P (Park).

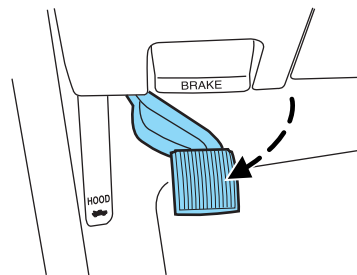

3. Turn the key to 3 (on) without turning the key to 4 (start).

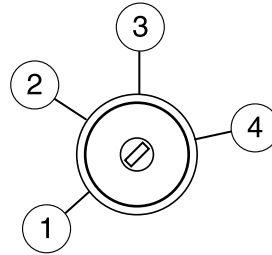

Some warning lights will briefly illuminate. See *Warning lights and chimes* in the *Instrument Cluster* chapter for more information regarding the warning lights.

Starting the engine

1. Turn the key to 3 (on) without turning the key to 4 (start). If there is difficulty in turning the key, rotate the steering wheel until the key turns freely. This condition may occur when:

- the front wheels are turned.
- a front wheel is against the curb.

2. Turn the key to 4 (start), then release the key as soon as the engine begins cranking. Your vehicle has a computer assisted cranking system that assists in starting the engine. After releasing the key from the 4 (start) position, the engine may continue cranking for up to 10 seconds or until the vehicle starts.

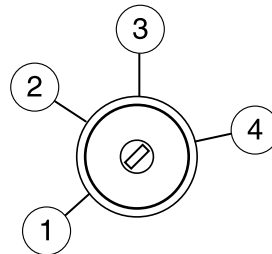

Note: Cranking may be stopped at any time by turning the key to the off position.

3. After idling for a few seconds, release the parking brake, apply the brake, shift into gear and drive.

Note: If the engine does not start on the first try, turn the key to the off position, wait 10 seconds and try Step 2 again. If the engine still fails to start, press the accelerator to the floor and try Step 2 again, keeping the accelerator on the floor until the engine begins to accelerate above cranking speeds; this will allow the engine to crank with the fuel shut off in case the engine is flooded with fuel.

Your vehicle may have remote start capability. Refer to *Remote entry system* in the *Locks and Security* chapter.

Driving

Cold weather starting (flexible fuel vehicles only)

The starting characteristics of all grades of E₈₅ ethanol make it unsuitable for use when ambient temperatures fall below 0°F (-18°C). Consult your fuel distributor for the availability of winter grade ethanol. As the outside temperature approaches freezing, ethanol fuel distributors should supply winter grade ethanol (same as with unleaded gasoline). If summer grade ethanol is used in cold weather conditions, 0°F to 32°F (-18°C to 0°C), you may experience increased cranking times, rough idle or hesitation until the engine has warmed up.

You may experience a decrease in peak performance when the engine is cold when operating on E₈₅ ethanol.

Do not crank the engine for more than 10 seconds at a time as starter damage may occur. If the engine fails to start, turn the key to off and wait 30 seconds before trying again.

Do not use starting fluid such as ether in the air intake system. Such fluid could cause immediate explosive damage to the engine and possible personal injury.

If you should experience cold weather starting problems on E₈₅ ethanol, and neither an alternative brand of E₈₅ ethanol nor an engine block heater is available, the addition of unleaded gasoline to your tank will improve cold starting performance. Your vehicle is designed to operate on E₈₅ ethanol alone, unleaded gasoline alone, or any mixture of the two.

See *Choosing the right fuel* in the *Maintenance and Specifications* chapter for more information on ethanol.

If the engine fails to start using the preceding instructions (flexible fuel vehicles only)

1. Press and hold down the accelerator 1/3 to 1/2 way to floor, then crank the engine.
2. When the engine starts, release the key, then gradually release the accelerator pedal as the engine speeds up. If the engine still fails to start, repeat Step 1.

Guarding against exhaust fumes

Carbon monoxide is present in exhaust fumes. Take precautions to avoid its dangerous effects.



WARNING: If you smell exhaust fumes inside your vehicle, have your dealer inspect your vehicle immediately. Do not drive if you smell exhaust fumes.

Important ventilating information

If the engine is idling while the vehicle is stopped for a long period of time, open the windows at least 1 inch (2.5 cm) or adjust the heating or air conditioning to bring in fresh air.

ENGINE BLOCK HEATER (IF EQUIPPED)

An engine block heater warms the engine coolant which aids in starting and allows the heater/defroster system to respond quickly. If your vehicle is equipped with this system, your equipment includes a heater element which is installed in your engine block and a wire harness which allows the user to connect the system to a grounded 120 volt A/C electrical source. The block heater system is most effective when outdoor temperatures reach below 0°F (-18°C).

For flexible fuel vehicles, if operating with E₈₅ ethanol, an engine block heater must be used if ambient temperature is below 0°F (-18°C).

See *Cold weather starting* earlier in this chapter for more information on starting with ethanol.



WARNING: Failure to follow engine block heater instructions could result in property damage or physical injury.



WARNING: To reduce the risk of electrical shock, do not use your heater with ungrounded electrical systems or two-pronged (cheater) adapters.

Prior to using the engine block heater, follow these recommendations for proper and safe operation:

- For your safety, use an outdoor extension cord that is product certified by Underwriter's Laboratory (UL) or Canadian Standards Association (CSA). Use only an extension cord that can be used outdoors, in cold temperatures, and is clearly marked "Suitable for Use with Outdoor Appliances." Never use an indoor extension cord outdoors; it could result in an electric shock or fire hazard.
- Use a 16 gauge outdoor extension cord, minimum.
- Use as short an extension cord as possible.
- Do not use multiple extension cords. Instead, use one extension cord which is long enough to reach from the engine block heater cord to the outlet without stretching.

Driving

- Make certain that the extension cord is in excellent condition (not patched or spliced). Store your extension cord indoors at temperatures above 32°F (0°C). Outdoor conditions can deteriorate extension cords over a period of time.
- To reduce the risk of electrical shock, do not use your heater with ungrounded electrical systems or two pronged (cheater) adapters. Also ensure that the block heater, especially the cord, is in good condition before use.
- Make sure that when in operation, the extension cord plug /engine block heater cord plug connection is free and clear of water in order to prevent possible shock or fire.
- Be sure that areas where the vehicle is parked are clean and clear of all combustibles such as petroleum products, dust, rags, paper and similar items.
- Be sure that the engine block heater, heater cord and extension cord are solidly connected. A poor connection can cause the cord to become very hot and may result in an electrical shock or fire. Be sure to check for heat anywhere in the electrical hookup once the system has been operating for approximately a half hour.
- Finally, have the engine block heater system checked during your fall tune-up to be sure it's in good working order.

How to use the engine block heater

Ensure the receptacle terminals are clean and dry prior to use. To clean them, use a dry cloth.

Depending on the type of factory installed equipment, your engine block heater system may consume anywhere between 400 watts or 1000 watts of power per hour. Your factory installed block heater system does not have a thermostat; however, maximum temperature is attained after approximately three hours of operation. Block heater operation longer than three hours will not improve system performance and will unnecessarily use additional electricity.

Make sure system is unplugged and properly stowed before driving the vehicle. While not in use, make sure the protective cover seals the prongs of the engine block heater cord plug.

BRAKES

Occasional brake noise is normal. If a metal-to-metal, continuous grinding or continuous squeal sound is present, the brake linings may be worn-out and should be inspected by an authorized dealer. If the vehicle has continuous vibration or shudder in the steering wheel while braking, the vehicle should be inspected by an authorized dealer.

Refer to *Warning lights and chimes* in the *Instrument Cluster* chapter for information on the brake system warning light.



Four-wheel anti-lock brake system (ABS)

Your vehicle is equipped with an anti-lock braking system (ABS). This system helps you maintain steering control during emergency stops by keeping the brakes from locking. Noise from the ABS pump motor and brake pedal pulsation may be observed during ABS braking and the brake pedal may suddenly travel a little farther as soon as ABS braking is done and normal brake operation resumes. These are normal characteristics of the ABS and should be no reason for concern.

Using ABS

When hard braking is required, apply continuous force on the brake pedal; do not pump the brake pedal since this will reduce the effectiveness of the ABS and will increase your vehicle's stopping distance. The ABS will be activated immediately, allowing you to retain steering control during hard braking and on slippery surfaces. However, the ABS does not decrease stopping distance.

Brake assist

The brake assist system provides full braking force during panic braking situations. It detects a rapid application of the brake pedal and uses the ABS system to achieve maximum braking pressure. Once a panic brake application is detected, the system will remain activated as long as the brake pedal is pressed or ABS is engaged. The system is deactivated by either releasing the brake pedal or coming to a complete stop. When the system activates, noise from the ABS pump motor and brake pedal pulsation may be observed; this is normal.

Driving

ABS warning lamp

The ABS lamp in the instrument cluster momentarily illuminates when the ignition is turned on. If the light does not illuminate during start up, remains on or flashes, the ABS may be disabled and may need to be serviced.



Even when the ABS is disabled, normal braking is still effective. If your BRAKE warning lamp illuminates with the parking brake released, have your brake system serviced immediately by an authorized dealer.

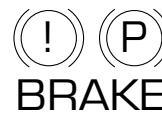

Parking brake

To set the parking brake, press the parking brake pedal down until the pedal stops.

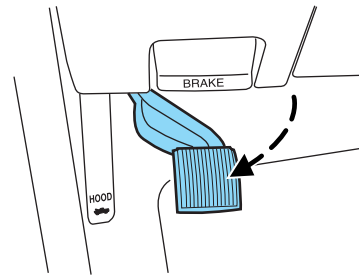

The BRAKE warning lamp in the instrument cluster illuminates and remains illuminated until the parking brake is released.

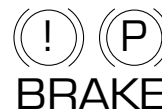

Driving

Pull the release lever to release the parking brake. To prevent the pedal from releasing too quickly, place your left foot on the service brake pedal, then slowly pull the release lever until the pedal slowly releases. Make sure that the pedal is fully released. You may want to pull the release lever again to make sure the parking brake is fully released.

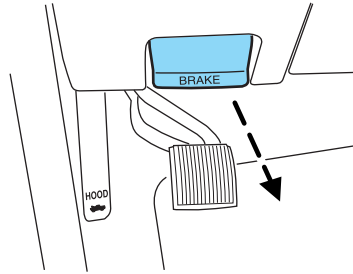

WARNING: Always set the parking brake fully and make sure that the gearshift is securely latched in P (Park).

If you're parking your vehicle on a grade or with a trailer, press and hold the brake pedal down, then set the parking brake. There may be a little vehicle movement as the parking brake sets to hold the vehicle's weight. This is normal and should be no reason for concern. If needed, press and hold the service brake pedal down, then try reapplying the parking brake. Chock the wheels if required. If the parking brake cannot hold the weight of the vehicle, the parking brake may need to be serviced or the vehicle may be overloaded.

ENGINE ONLY TRACTION CONTROL (ALL DUAL REAR WHEEL (DRW) VEHICLES)

This system helps you maintain the stability and steerability of your vehicle, especially on slippery road surfaces such as snow- or ice-covered roads and gravel roads. The system will allow your vehicle to make better use of available traction in these conditions.

During traction control operation, the traction control light will illuminate and the engine will not "rev-up" when you press further on the accelerator. This is normal system behavior and should be no



reason for concern. Also, if traction control is on when the vehicle is put into four-wheel drive mode (if equipped), the traction control system will be automatically disabled. Traction control operation will resume when the vehicle is placed back into two-wheel drive mode.

Driving



WARNING: Aggressive driving in any road conditions can cause you to lose control of your vehicle increasing the risk of severe personal injury or property damage. The occurrence of a traction control event is an indication that at least some of the tires have exceeded their ability to grip the road; this may lead to an increased risk of loss of vehicle control, vehicle rollover, personal injury and death. If you experience a severe road event, SLOW DOWN.

The traction control switch, located on the instrument panel to the right of the climate control system, has an indicator light that illuminates when the system is off. The traction control system will automatically turn on every time the ignition is turned off and on. The traction control system should normally be left on.

TCS OFF

If you should become stuck in snow or ice or on a very slippery road surface, try switching the traction control system off. This may allow excess wheel spin to “dig” the vehicle out and enable a successful “rocking” maneuver.

If a system fault is detected, the traction control active light will illuminate, the traction control button will not turn the system on or off and your vehicle should be serviced by an authorized dealer.

ADVANCETRAC® WITH ROLL STABILITY CONTROL™ (RSC®) STABILITY ENHANCEMENT SYSTEM (ALL SINGLE REAR WHEEL (SRW) VEHICLES)

The AdvanceTrac® with RSC® system provides the following stability enhancement features for certain driving situations:

- Traction control system (TCS), which functions to help avoid drive-wheel spin and loss of traction.
- Electronic stability control (ESC), which functions to help avoid skids or lateral slides.
- Roll Stability Control™ (RSC®), which functions to help avoid a vehicle roll-over.

Driving

 **WARNING:** Vehicle modifications involving braking system, aftermarket roof racks, suspension, steering system, tire construction and/or wheel/tire size may change the handling characteristics of the vehicle and may adversely affect the performance of the AdvanceTrac® with RSC® system. In addition, installing any stereo loudspeakers may interfere with and adversely affect the AdvanceTrac® with RSC® system. Install any aftermarket stereo loudspeaker as far as possible from the front center console, the tunnel, and the front seats in order to minimize the risk of interfering with the AdvanceTrac® with RSC® sensors. Reducing the effectiveness of the AdvanceTrac® with RSC® system could lead to an increased risk of loss of vehicle control, vehicle rollover, personal injury and death.

 **WARNING:** Remember that even advanced technology cannot defy the laws of physics. It's always possible to lose control of a vehicle due to inappropriate driver input for the conditions. Aggressive driving on any road condition can cause you to lose control of your vehicle increasing the risk of personal injury or property damage. Activation of the AdvanceTrac® with RSC® system is an indication that at least some of the tires have exceeded their ability to grip the road; this could reduce the operator's ability to control the vehicle, potentially resulting in a loss of vehicle control, vehicle rollover, personal injury and death. If your AdvanceTrac® with RSC® system activates, SLOW DOWN.

 **WARNING:** If a failure has been detected within the AdvanceTrac® with RSC® system, the stability control light will illuminate steadily. Verify that the AdvanceTrac® with RSC® system is not manually disabled. Press the stability control button located on the instrument panel to the right of the climate control system. If the stability control light still illuminates steadily, have the system serviced by an authorized dealer immediately. Operating your vehicle with AdvanceTrac® with RSC® disabled could lead to an increased risk of loss of vehicle control, vehicle rollover, personal injury and death.

The AdvanceTrac® with RSC® system automatically enables each time the engine is started. All features of the AdvanceTrac® with RSC® system (TCS, ESC, and RSC®) are active and monitor the vehicle from start-up. However, the system will only intervene if the driving situation requires it.

Driving

The AdvanceTrac® with RSC® system includes a stability control button located on the instrument panel to the right of the climate control system, a stability control light and a stability control off light in the instrument cluster. Both

lights will illuminate temporarily during start-up as part of a normal system self-check. The stability control light may illuminate (flash) during certain driving situations which cause the AdvanceTrac® with RSC® system to operate. If the stability control light and stability control off light illuminate steadily, have the system serviced by an authorized dealer immediately. The message center will also indicate a failure with the AdvanceTrac® with RSC® system.



Note: If the system cannot be turned off, refer to *MyKey™* in the *Locks and Security* chapter for more information.

When AdvanceTrac® with RSC® performs a normal system self-check, some drivers may notice a slight movement of the brake, and/or a rumble, grunting, or grinding noise after startup and when driving off.

When an event occurs that activates AdvanceTrac® with RSC® you may experience the following:

- A slight deceleration of the vehicle
- The stability control light will flash.
- A vibration in the pedal when your foot is on the brake pedal
- If the driving condition is severe and your foot is not on the brake, the brake pedal may move as the systems applies higher brake forces. You may also hear a whoosh of air from under the instrument panel during this severe condition.
- The brake pedal may feel stiffer than usual.

Traction control system (TCS)

Traction control is a driver aid feature that helps your vehicle maintain traction of the wheels, typically when driving on slippery and/or hilly road surfaces, by detecting and controlling wheel spin.

Excessive wheel spin is controlled in two ways, which may work separately or in tandem: engine traction control and brake traction control. Engine traction control works to limit drive-wheel spin by momentarily reducing engine power. Brake traction control works to limit wheel spin by momentarily applying the brakes to the wheel that is slipping. Traction control is most active at low speeds.

270

During TCS events the stability control light in the instrument cluster will flash.

If the TCS is activated excessively in a short period of time, the braking portion of the system may become temporarily disabled to allow the brakes to cool down. In this situation, TCS will use only engine power reduction to help control the wheels from over-spinning. When the brakes have cooled down, the system will regain all features. Anti-lock braking, RSC®, and ESC are not affected by this condition and will continue to function during the cool-down period.

The engine traction control and brake traction control system may be deactivated in certain situations. See the *Switching off AdvanceTrac® with RSC®* section following.

Electronic stability control (ESC)

Electronic stability control (ESC) may enhance your vehicle's directional stability during adverse maneuvers, for example when cornering severely or avoiding objects in the roadway. ESC operates by applying brakes to one or more of the wheels individually and, if necessary, reducing engine power if the system detects that the vehicle is about to skid or slide laterally.

During ESC events, the stability control light in the instrument cluster will flash.

Certain adverse driving maneuvers may activate the ESC system, which include but are not limited to:

- Taking a turn too fast
- Maneuvering quickly to avoid an accident, pedestrian or obstacle
- Driving over a patch of ice or other slippery surfaces
- Changing lanes on a snow-rutted road
- Entering a snow-free road from a snow-covered side street, or vice versa
- Entering a paved road from a gravel road, or vice versa
- Cornering while towing a heavily loaded trailer (refer to *Trailer towing* in the *Tires, Wheels and Loading* chapter).

The ESC system may be deactivated in certain situations. See the *Switching off AdvanceTrac® with RSC®* section following.

Driving

Roll Stability Control™ (RSC®)

Roll Stability Control™ (RSC®) may help to maintain roll stability of the vehicle during adverse maneuvers. RSC® operates by detecting the vehicle's roll motion and the rate at which it changes and by applying the brakes to one or more wheels individually.

During an event that activates the Roll Stability Control™ (RSC®) the stability control light in the instrument cluster will flash.

Certain adverse driving maneuvers may activate the Roll Stability Control™ system, which include:

- Emergency lane-change
- Taking a turn too fast
- Quick maneuvering to avoid an accident, pedestrian or obstacle

The Roll Stability Control™ system may be deactivated in certain situations. See the *Switching off AdvanceTrac® with RSC®* section following.

Switching off AdvanceTrac® with RSC®

If the vehicle is stuck in snow, mud or sand, and seems to lose engine power, switching off certain features of the AdvanceTrac® with RSC® system may be beneficial because the wheels are allowed to spin. This will restore full engine power and will enhance momentum through the obstacle. To switch off the AdvanceTrac® with RSC® system, press the stability control button located on the instrument panel to the right of the climate control system. Full features of the AdvanceTrac® with RSC® system can be restored by pressing the button again or by turning off and restarting the engine.

If you switch off the AdvanceTrac® with RSC® system, the stability control off light will illuminate steadily. Pressing the stability control button again will turn off the stability control off light.

In R (Reverse), ABS and the engine traction control and brake traction control features will continue to function; however, ESC and RSC® are disabled.

Driving

AdvanceTrac® with RSC® Features				
Button functions	Stability control light 	RSC®	ESC	TCS
Default at start-up	Illuminated during bulb check	Enabled	Enabled	Enabled
Button pressed momentarily	Illuminated solid	Enabled	Enabled ¹	Disabled
Button pressed and held for more than 5 seconds at vehicle speed under 35 mph (56 km/h)	Flashes then illuminated solid ²	Disabled	Disabled	Disabled
Vehicle speed exceeds 35 mph (56 km/h) after button is pressed and held for more than 5 seconds	Illuminated solid	Enabled	Enabled ¹	Disabled
Button pressed again after deactivation	Not illuminated	Enabled	Enabled	Enabled
Transfer case switched to 4WD Low Locked ^{3,4}	Illuminated	Disabled	Disabled	Disabled

¹TCS is enabled but with higher entry thresholds compared to full system.

²Lamp light starts blinking for 4 seconds after entering press and hold state.

³Control switch is not pressed. Stability control off light turned on when 4WD low locked transfer case mode selected.

⁴If the button is pressed in 2WD or 4WD high, any change in the transfer case mode will return the AdvanceTrac® to fully enabled.

Driving

Trailer sway control

Your vehicle may be equipped with trailer sway control. When properly equipped, trailer sway control will use the vehicle's AdvanceTrac® with RSC® system to detect and help reduce trailer sway by applying brake force at individual wheels and, if necessary, by reducing engine power.

 **WARNING:** Trailer sway control does not prevent a trailer from swaying, it mitigates the sway from increasing once it has occurred. If you are experiencing trailer sway it is likely that the trailer is improperly loaded for the correct tongue weight or the speed of the vehicle and trailer is too high. Pull the vehicle-trailer over to a safe location to check the trailer weight distribution and tongue load and reduce speed to a safe level while towing. If trailer sway is experienced, SLOW DOWN.

During trailer sway control events the stability control light in the instrument cluster will flash momentarily. The message center will also display **TRAILER SWAY REDUCE SPEED**. In some cases when trailer sway is detected, the vehicle speed is too high and may be above a speed at which trailer sway will not grow continuously. This may cause the system to activate multiple times, causing a gradual reduction in speed.

Disabling trailer sway control

Trailer sway control can be disabled during any key cycle. See trailer sway control under the *Message center* in the *Instrument Cluster* chapter. Note that regardless of chosen enable state, trailer sway control will be re-enabled at each new key cycle.

 **WARNING:** Turning off trailer sway control increases the risk of loss of vehicle control, serious injury, or death. Ford does not recommend disabling this feature except in situations where speed reduction may be detrimental (e.g., hill climbing), the driver has significant trailer towing experience, and can control trailer sway and maintain safe operation.

HILL DESCENT CONTROL (IF EQUIPPED)

Hill descent control allows the driver to set and maintain vehicle speed while descending steep grades in various surface conditions.



WARNING: Hill descent control cannot control descent in all surface conditions and circumstances, such as ice or extremely steep grades. Hill descent control is a driver assist system and cannot substitute for good judgment by the driver. Failure to do so may result in loss of vehicle control, crash or serious injury.

Hill descent control can maintain vehicle speeds on downhill grades between 2 mph (3 km/h) and 12 mph (20 km/h). Above 20 mph (32 km/h), the system remains armed, but descent speed cannot be set or maintained.



WARNING: Hill descent control does not provide hill hold at zero mph (0 km/h). When stopped, the parking brake must be applied and/or the vehicle must be placed in P (Park) or it may roll away.

Hill descent control requires a cooling down interval after a period of sustained use. The amount of time that the feature can remain active before cooling varies with conditions. The system will provide a warning in the message center and a chime will sound when the system is about to disengage for cooling. At this time, manually apply the brakes as needed to maintain descent speed.

Enabling hill descent control and setting the descent speed

1. Press and release the hill descent button located on the instrument panel. A light in the cluster will illuminate and chime will sound when this feature is activated.

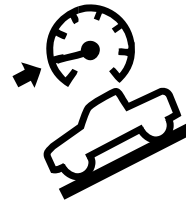

2. To increase descent speed, press the accelerator pedal until the desired speed is reached. To decrease descent speed, press the brake pedal until the desired speed is reached.

Whether accelerating or decelerating, once the desired descent speed is reached, remove your feet from the pedals and the chosen vehicle speed will be maintained.

Driving

Note: Noise from the ABS pump motor may be observed during hill descent control operation. This is a normal characteristic of the ABS and should be no reason for concern.

Hill descent modes

- At speeds below 20 mph (32 km/h): When the HDC switch is pressed and HDC is active, the HDC telltale will flash.
- At speeds below 20 mph (32 km/h): When the HDC switch is pressed and conditions are not correct for hill descent activation, the HDC system will be enabled, the light in the cluster will be on solid and HILL DESCENT CONTROL READY will be displayed in the message center.
- At speeds above 20 mph (32 km/h): When the HDC switch is pressed, the HDC system will be enabled, the light in the cluster will not be illuminated and FOR HILL CNTRL, 20 MPH OR LESS will be displayed in the message center.

Refer to *Message center* in the *Instrument Cluster* chapter for hill descent control messages.

STEERING

To help prevent damage to the power steering system:

- Never hold the steering wheel at its furthest turning points (until it stops) for more than three to five seconds when the engine is running.
- Do not operate the vehicle with a low power steering pump fluid level (below the MIN mark on the reservoir).
- Some noise is normal during operation. If excessive, check for low power steering pump fluid level before seeking service by your dealer.
- Heavy or uneven efforts may be caused by low power steering fluid. Check for low power steering pump fluid level before seeking service by your dealer.
- Do not fill the power steering pump reservoir above the MAX mark on the reservoir, as this may result in leaks from the reservoir.

If the power steering system breaks down (or if the engine is turned off), you can steer the vehicle manually, but it takes more effort.

If the steering wanders or pulls, check for:

- an improperly inflated tire
- uneven tire wear
- loose or worn suspension components

276

- loose or worn steering components
- improper steering alignment

If any steering components are serviced or replaced, install new fasteners (many are coated with thread adhesive or have prevailing torque features which may not be re-used). Never re-use a bolt or nut. Torque fasteners to specifications in *Workshop Manual*.

A high crown in the road or high crosswinds may also make the steering seem to wander/pull.

ELECTRONIC LOCKING DIFFERENTIAL (ELD) (IF EQUIPPED)

The electronic locking differential (ELD) is a device housed in the rear axle which allows both rear wheels to turn at the same speed. It provides added traction on slippery and/or off road surfaces, particularly when one wheel is on a poor traction surface. The ELD may be locked or unlocked by the vehicle operator and can be engaged or disengaged on the fly. When the axle is unlocked it will function like a standard rear axle. When the axle is locked it will not allow the rear wheels to rotate at different speeds when turning. It is not recommended for use on good traction surfaces such as dry pavement. Doing so may result in abnormal driving behavior and noise while cornering and excessive tire wear.

The ELD is affected by the following conditions of your vehicle:

- On 2WD vehicles and 4WD vehicles in 2H (4X2) or 4H (4X4 High), the ELD will not engage if the vehicle speed is above 25 mph (40 km/h).
- On 2WD vehicles and 4WD vehicles in 2H (4X2) or 4H (4X4 High), the ELD will automatically disengage at speeds above 25 mph (40 km/h) and will automatically reengage at speeds below 19 mph (30 km/h).
- On 4WD vehicles in 4L (4X4 Low), the ELD can be engaged at any speed and will not automatically disengage.

Activating the electronic locking differential (ELD)

For vehicles equipped with an electronic shift 4WD system:

Pull the knob on the 4WD control toward you. The  indicator light will display in the instrument cluster.

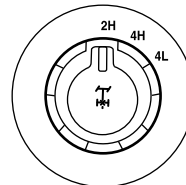



Driving

For 2WD vehicles and vehicles equipped with a manual shift 4WD system:

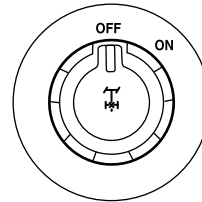
Turn the control to ON. The  indicator light will display in the instrument cluster.



Once the  light is displayed in the instrument cluster, both rear wheel axle shafts will be locked together providing added traction.

If the  indicator light in the instrument cluster turns off, one of the following has occurred:

- The vehicle speed is too high.
- The left and right rear wheel speed difference is too high during an engagement attempt.
- The system has malfunctioned and will be accompanied by the CHECK LOCKING DIFFERENTIAL message in the message center. See your authorized Ford dealer for assistance.

Note: The ELD may have difficulty disengaging either by operator command or automatically if the driveline is under torque. If driving conditions allow, releasing the accelerator pedal or turning the steering wheel in the opposite direction may assist in disengagement.

Note: The ELD is designed for off-road use only and is not intended for use on dry pavement.

PREPARING TO DRIVE



WARNING: Utility vehicles have a significantly higher rollover rate than other types of vehicles.





WARNING: In a rollover crash, an unbelted person is significantly more likely to die than a person wearing a seat belt.

Utility vehicles and trucks have larger tires and increased ground clearance, giving the vehicle a higher center of gravity than a passenger car.

278

Driving

 **WARNING:** Vehicles with a higher center of gravity such as utility vehicles and trucks handle differently than vehicles with a lower center of gravity. Utility vehicles and trucks are **not** designed for cornering at speeds as high as passenger cars any more than low-slung sports cars are designed to perform satisfactorily under off-road conditions. Avoid sharp turns, excessive speed or abrupt maneuvers in these vehicles. Failure to drive cautiously could result in an increased risk of loss of vehicle control, vehicle rollover, personal injury and death.

 **WARNING:** Loaded vehicles, with a higher center of gravity, may handle differently than unloaded vehicles. Do not overload your vehicle and use extra precautions, such as driving at slower speeds, avoiding abrupt steering changes and allowing for increased stopping distance, when driving a heavily loaded vehicle. Over-loading or loading the vehicle improperly can deteriorate handling capability and contribute to loss of vehicle control and vehicle rollover.

BRAKE-SHIFT INTERLOCK

This vehicle is equipped with a brake-shift interlock feature that prevents the gearshift lever from being moved from P (Park) when the ignition is in the 3 (on) position and the brake pedal is not pressed.

If you cannot move the gearshift lever out of P (Park) with ignition in the on position and the brake pedal pressed, it is possible that a fuse has blown or the vehicle's brake lamps are not operating properly. Refer to *Fuses and relays* in the *Roadside Emergencies* chapter.

If the fuse is not blown and the brake lamps are working properly, the following procedure will allow you to move the gearshift lever from P (Park):

1. Apply the parking brake. Turn the ignition key to 1 (off), then remove the key.
2. Move the steering column to the full down and full rearward position (toward the driver's seat).
3. Remove the gearshift lever boot.
4. Place fingers into hole where the gearshift lever boot was removed from and pull top half of shroud up and forward to separate it from the lower half of the shroud. There is a hinge at the forward edge of the top shroud. Roll the top half of the shroud upward on the hinge point to clear the hazard flasher button, then pull straight rearward toward the driver's seat to remove.

279

Driving

5. Remove the top half of the shroud.
6. Remove the three fasteners under the column that secure the lower shroud half to the column.

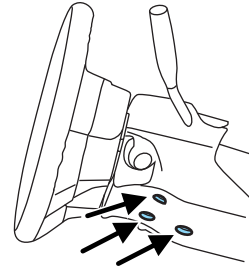

7. Pull the lock lever into the full unlocked position and remove the lower shroud cover by pulling the lever handle through the slot in the cover.

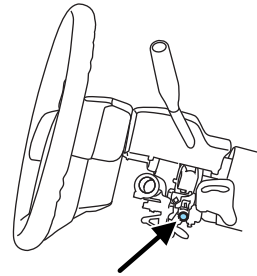

8. Apply the brake and move the gearshift lever into N (Neutral).
9. Start the vehicle.

Perform Steps 4 through 8 in reverse order, making sure to engage the hinge pivots between the upper and lower halves of the shroud. Keep slight pressure in the forward direction as the halves are rotated together.



WARNING: Do not drive your vehicle until you verify that the brake lamps are working.



WARNING: Always set the parking brake fully and make sure the gearshift is latched in P (Park). Turn the ignition to the off position and remove the key whenever you leave your vehicle.



WARNING: If the parking brake is fully released, but the brake warning lamp remains illuminated, the brakes may not be working properly. See your authorized dealer as soon as possible.

AUTOMATIC TRANSMISSION OPERATION

Understanding the shift positions of the 5-speed automatic transmission (if equipped)

P R N D 3 2 1

This vehicle is equipped with an adaptive transmission shift strategy. Adaptive transmission shift strategy offers the optimal transmission operation and shift quality. When the vehicle's battery has been disconnected for any type of service or repair, the transmission will need to relearn the normal shift strategy parameters, much like having to reset your radio stations when your vehicle battery has been disconnected. The adaptive transmission shift strategy allows the transmission to relearn these operating parameters. This learning process could take several transmission upshifts and downshifts; during this learning process, slightly firmer shifts may occur. After this learning process, normal shift feel and shift scheduling will resume.

P (Park)

This position locks the transmission and prevents the rear wheels from turning.

To put your vehicle in gear:

- Start the engine
- Press the brake pedal
- Move the gearshift lever into the desired gear

To put your vehicle in P (Park):

- Come to a complete stop
- Move the gearshift lever and securely latch it in P (Park)



WARNING: Always set the parking brake fully and make sure the gearshift is latched in P (Park). Turn the ignition to the off position and remove the key whenever you leave your vehicle.

R (Reverse)

With the gearshift lever in R (Reverse), the vehicle will move backward. Always come to a complete stop before shifting into and out of R (Reverse).

Driving

N (Neutral)

With the gearshift lever in N (Neutral), the vehicle can be started and is free to roll. Hold the brake pedal down while in this position.

D (Overdrive) with Tow/Haul Off

D (Overdrive) with tow/haul off is the normal driving position for the best fuel economy. The overdrive function allows automatic upshifts and downshifts through gears one through five.

D (Overdrive) with Tow/Haul On

The tow/haul feature improves transmission operation when towing a trailer or a heavy load. All transmission gear ranges are available when using tow/haul.

To activate tow/haul, press the button on the end of the gearshift lever.

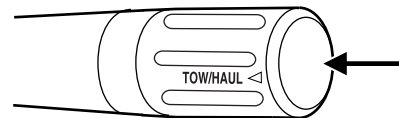

The TOW HAUL indicator light will illuminate in the instrument cluster.

**TOW
HAUL**

Tow/haul delays upshifts to reduce frequency of transmission shifting. Tow/haul also provides engine braking in all forward gears when the transmission is in the D (Overdrive) position; this engine braking will slow the vehicle and assist the driver in controlling the vehicle when descending a grade. Depending on driving conditions and load conditions, the transmission may downshift, slow the vehicle and control the vehicle speed when descending a hill, without the accelerator pedal being pressed. The amount of downshift braking provided will vary based upon the amount the brake pedal is depressed.

To deactivate the tow/haul feature and return to normal driving mode, press the button on the end of the gearshift lever. The TOW HAUL light will no longer be illuminated.

When you shut-off and restart the engine, the transmission will automatically return to normal D (Overdrive) mode (Tow/Haul OFF).



WARNING: Do not use the tow/haul feature when driving in icy or slippery conditions as the increased engine braking can cause the rear wheels to slide and the vehicle to swing around with the possible loss of vehicle control.

3 (Third)

Transmission starts and operates in third gear only.

Used for improved traction on slippery roads. Selecting 3 (Third) provides engine braking.

2 (Second)

Use 2 (Second) to start-up on slippery roads or to provide additional engine braking on downgrades.

1 (First)

- Provides maximum engine braking.
- Allows upshifts by moving gearshift lever.
- The transmission will not downshift into 1 (First) at high speeds; it will downshift to a lower gear and then shift into 1 (First) when the vehicle reaches slower speeds.

Forced downshifts

- Allowed in D (Overdrive) or D (Drive).
- Press the accelerator to the floor.
- Allows transmission to select an appropriate gear.

Understanding the shift positions of the 6-speed automatic transmission (if equipped)



This vehicle is equipped with an adaptive transmission shift strategy. Adaptive transmission shift strategy offers the optimal transmission operation and shift quality. When the vehicle's battery has been disconnected for any type of service or repair, the transmission will need to relearn the normal shift strategy parameters, much like having to reset your radio stations when your vehicle battery has been disconnected. The adaptive transmission shift strategy allows the transmission to relearn these operating parameters. This learning process could take several transmission upshifts and downshifts; during this learning process, slightly firmer shifts may occur. After this learning process, normal shift feel and shift scheduling will resume.

Driving

P (Park)

This position locks the transmission and prevents the rear wheels from turning.

To put your vehicle in gear:

1. Start the engine
2. Press the brake pedal
3. Move the gearshift lever into the desired gear

To put your vehicle in P (Park):

1. Come to a complete stop
2. Move the gearshift lever and securely latch it in P (Park)



WARNING: Always set the parking brake fully and make sure the gearshift is latched in P (Park). Turn the ignition to the off position and remove the key whenever you leave your vehicle.

R (Reverse)

With the gearshift lever in R (Reverse), the vehicle will move backward. Always come to a complete stop before shifting into and out of R (Reverse).

N (Neutral)

With the gearshift lever in N (Neutral), the vehicle can be started and is free to roll. Hold the brake pedal down while in this position.

D (Overdrive) with Tow/Haul Off

D (Overdrive) with tow/haul off is the normal driving position for the best fuel economy. The overdrive function allows automatic upshifts and downshifts through gears one through six.

D (Overdrive) with Tow/Haul On

The tow/haul feature improves transmission operation when towing a trailer or a heavy load. All transmission gear ranges are available when using tow/haul.

To activate tow/haul, press the button on the end of the gearshift lever.

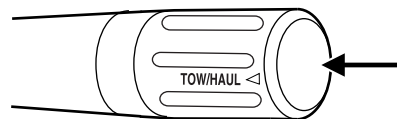

Driving

The TOW HAUL indicator light will illuminate in the instrument cluster.

TOW HAUL

Tow/haul delays upshifts to reduce frequency of transmission shifting. Tow/haul also provides engine braking in all forward gears when the transmission is in the D (Overdrive) position; this engine braking will slow the vehicle and assist the driver in controlling the vehicle when descending a grade. Depending on driving conditions and load conditions, the transmission may downshift, slow the vehicle and control the vehicle speed when descending a hill, without the brake pedal being pressed. The amount of downshift braking provided will vary based upon the amount the brake pedal is pressed.

Tow/haul may be automatically activated (without pressing the tow/haul button). This provides engine braking to assist the vehicles braking system when going downhill and repetitive braking is sensed. Once the tow/haul mode has been automatically activated it will not automatically deactivate.

To deactivate the tow/haul feature and return to normal driving mode, press the button on the end of the gearshift lever. The tow/haul light will no longer be illuminated.

Tow/haul will also deactivate when the vehicle is powered down for a few minutes.



WARNING: Do not use the tow/haul feature when driving in icy or slippery conditions as the increased engine braking can cause the rear wheels to slide and the vehicle to swing around with the possible loss of vehicle control.

M (Manual) without Overdrive

With the gearshift lever in M (Manual), the driver can change gears up or down as desired. This is called SelectShift Automatic™ transmission (SST) mode. By moving the gearshift lever from drive position D (Overdrive) to M (Manual) you now have control of selecting the gear you desire using buttons on the shift lever.

To return to normal D (Overdrive) position, move the shift lever back from M to D.

- The transmission will operate in gears one through six.

2 (Second)

Use 2 (Second) to start-up on slippery roads or to provide additional engine braking on downgrades.

Driving

1 (First)

- Provides maximum engine braking.
- Allows upshifts by moving gearshift lever.
- The transmission will not downshift into 1 (First) at high speeds; it will downshift to a lower gear and then shift into 1 (First) when the vehicle reaches slower speeds.

Forced downshifts

- Allowed in D (Overdrive).
- Press the accelerator to the floor.
- Allows transmission to select an appropriate gear.

Understanding your SelectShift Automatic™ transmission (SST) gearshift lever

This vehicle is equipped with a SelectShift Automatic™ transmission (SST) gearshift lever. The SST is an automatic transmission with the ability for the driver to change gears up or down (without a clutch) as desired.

Use the buttons on the shifter to lock or unlock gears and manually select gears. Press the + button to upshift or the – button to downshift.

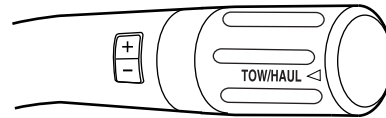

With the gearshift lever in D (Drive), press the – button to active SST. The available and selected gears will be indicated on the instrument cluster.

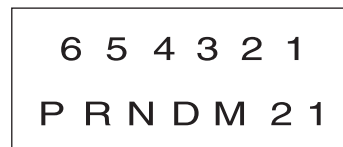

All available gears will be displayed with the current gear indicated. Press the – button again to lock out gears beginning with the highest gear. Example: press the – button twice to lock out 6th and 5th gears. Only the available gears will be displayed and the transmission will automatically shift between the available gears. Press the + button to unlock gears.

Driving

By moving the gearshift lever from the D (Drive) position to the M (Manual) position you may now manually select the gear you desire. Only the current gear will be displayed. Press the + button or the – button to upshift or downshift. If the – button is pressed at a vehicle speed that would cause an engine overspeed, the requested gear will flash then disappear and the transmission will remain in the current gear.

Recommended shift speeds

Upshift according to the following chart:

Upshifts when accelerating (recommended for best fuel economy)		
Shift from:	Gasoline engines	Diesel engines
1 – 2	15 mph (24 km/h)	12 mph (19 km/h)
2 – 3	25 mph (40 km/h)	19 mph (31 km/h)
3 – 4	40 mph (64 km/h)	26 mph (42 km/h)
4 – 5	45 mph (72 km/h)	34 mph (55 km/h)
5 – 6	50 mph (80 km/h)	46 mph (74 km/h)

In order to prevent the engine from running at too low an RPM, which may cause it to stall, the SST will still automatically make some downshifts if it has determined that you have not downshifted in time. Although the SST will make some downshifts for you, it will still allow you to downshift at any time as long as the SST determines that the engine will not be damaged from over-revving.

The SST will not automatically upshift, even if the engine is approaching the RPM limit. It must be shifted manually by pressing the + button.

Engine damage may occur if excessive engine revving is held without shifting.

Hill assist feature

The hill assist feature makes it easier to pull away when the vehicle is on a slope without the need to use the parking brake. When the hill assist feature is active, the vehicle will remain stationary on the slope for up to two seconds after you release the brake pedal. During this time, you have time to move your foot from the brake to the accelerator pedal and pull away. The brakes are released automatically once the engine has developed sufficient drive to prevent the vehicle from rolling down the slope. This is an advantage when pulling away on a slope; for example from a car park ramp, traffic lights or when reversing uphill into a parking space.

Driving



WARNING: The hill assist feature does not replace the parking brake. When you leave the vehicle, always apply the parking brake and select first or reverse gear.

Using the hill assist feature

The hill assist feature is activated automatically when the vehicle is stopped on a slope greater than five degrees. The hill assist feature operates with the vehicle facing downhill if reverse gear is selected. The hill assist feature will not operate if the parking brake is activated.



WARNING: You must remain in the vehicle once you have activated the hill assist feature.

Activating the hill assist feature

1. Press the brake pedal to bring the vehicle to a complete standstill. Keep the brake pedal pressed.
2. If the sensors detect that the vehicle is on a slope, the hill assist feature will be activated automatically.
3. When you remove your foot from the brake pedal, the vehicle will remain on the slope without rolling away for approximately up to two seconds. This hold time will automatically be extended if you are in the process of driving off.
4. Drive off in the normal manner. The brakes will be released automatically.



WARNING: If the engine is revved excessively, or if a malfunction is detected when the hill assist feature is active, the hill assist feature will be deactivated.

If your vehicle gets stuck in mud or snow

If your vehicle gets stuck in mud or snow, it may be rocked out by shifting between forward and reverse gears, stopping between shifts in a steady pattern. Press lightly on the accelerator in each gear.

Do not rock the vehicle if the engine is not at normal operating temperature or damage to the transmission may occur.

Do not rock the vehicle for more than a minute or damage to the transmission and tires may occur, or the engine may overheat.

REVERSE SENSING SYSTEM (IF EQUIPPED)

The reverse sensing system (RSS) sounds a tone to warn the driver of obstacles near the rear bumper when the R (Reverse) is selected and the vehicle is moving at speeds less than 3 mph (5 km/h). The system is not effective at speeds above 3 mph (5 km/h) and may not detect certain angular or moving objects.



WARNING: To help avoid personal injury, please read and understand the limitations of the reverse sensing system as contained in this section. Reverse sensing is only an aid for some (generally large and fixed) objects when moving in reverse on a flat surface at “parking speeds”. Inclement weather may also affect the function of the RSS; this may include reduced performance or a false activation.



WARNING: To help avoid personal injury, always use caution when in reverse and when using the RSS.



WARNING: This system is not designed to prevent contact with small or moving objects. The system is designed to provide a warning to assist the driver in detecting large stationary objects to avoid damaging the vehicle. The system may not detect smaller objects, particularly those close to the ground.



WARNING: Certain add-on devices such as large trailer hitches, bike or surfboard racks and any device that may block the normal detection zone of the RSS system may create false beeps.

Driving

The RSS detects obstacles up to 6 feet (2 meters) from the rear bumper with a decreased coverage area at the outer corners of the bumper, (refer to the figures for approximate zone coverage areas). As you move closer to the obstacle, the rate of the tone increases. When the obstacle is less than 10 inches (25.0 cm) away, the tone will sound continuously. If the RSS detects a stationary or receding object further than 10 inches (25.0 cm) from the side of the vehicle, the tone will sound for only three seconds. Once the system detects an object approaching, the tone will sound again.

While receiving a warning the radio volume may be reduced to a predetermined level. After the warning goes away, the radio will return to the previous volume.

The RSS may have reduced performance or an increased chance of false detection if the tailgate is not locked and in the upright position. If the tailgate is down, the RSS tone may be heard intermittently or continuously. The tone may also be heard if items in the truck bed protrude rearward outside the bed.

The RSS automatically turns on when the gearshift lever is placed in R (Reverse) and the ignition is on. A control in the message center allows the driver to disable the system. Refer to *Message center* in the *Instrument Cluster* chapter for more information.

Keep the RSS sensors (located on the rear bumper/fascia) free from snow, ice and large accumulations of dirt (do not clean the sensors with sharp objects). If the sensors are covered, it will affect the accuracy of the RSS.

If your vehicle sustains damage to the rear bumper/fascia, leaving it misaligned or bent, the sensing zone may be altered causing inaccurate measurement of obstacles or false alarms.

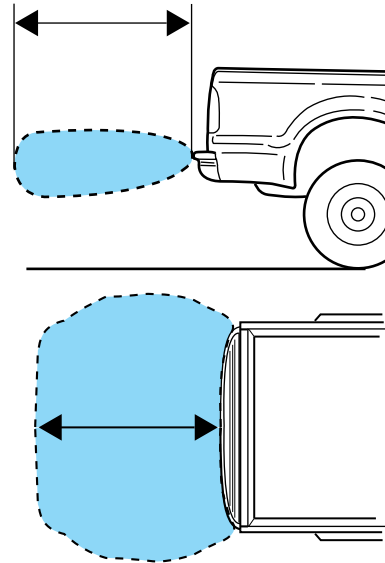

REARVIEW CAMERA SYSTEM (IF EQUIPPED)

The rearview camera system, located on the tailgate, provides a video image, which appears in the rearview mirror or on the navigation screen (if equipped), of the area behind the vehicle. It adds assistance to the driver while reversing or reverse parking the vehicle.

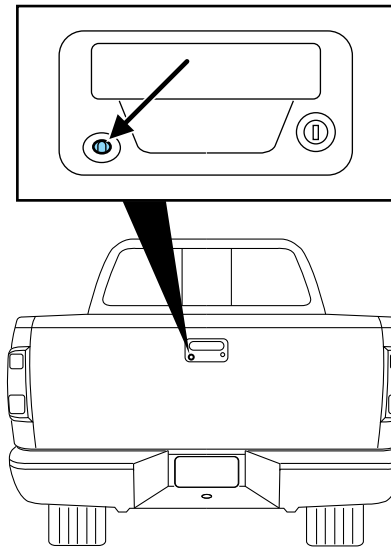

To use the camera system, place the transmission in R (Reverse); an image will display on the left portion of the rearview mirror or on the navigation screen (if equipped). The area displayed on the screen may vary according to the vehicle orientation and/or road condition.

- (1) Rear bumper
- (2) Red zone
- (3) Yellow zone
- (4) Green zone
- (5) Centerline of vehicle

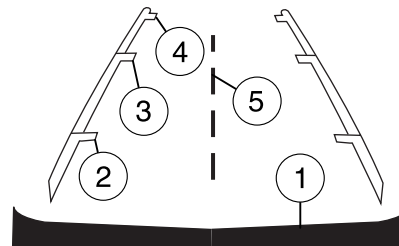

Always use caution while backing.

Objects in the red zone are closest to your vehicle and objects in the green zone are further away. Objects are getting closer to your vehicle as they move from the green zone to the yellow or red zones.

Use the side mirrors and rearview mirror to get better coverage on both sides and rear of the vehicle.

Driving

Image delay if displayed through the rearview mirror:

When shifting out of R (Reverse) and into any other gear, the image in the rearview mirror will remain on for a few seconds before it shuts off to assist in parking or trailer hookup.

Image delay if displayed through the navigation screen:

After shifting out of R (Reverse) and into any gear other than P (Park), the image in the navigation screen will remain until the vehicle speed reaches 5 mph (8 km/h), only if the rear camera delay feature is on, or until any navigation radio button is pressed.

Note: The default setting for the rear camera delay is off. Press the “Settings” button found on the navigation screen (if equipped) to set the rear camera delay feature to on or off.

When towing, the camera system will only see what is being towed behind the vehicle; this might not provide adequate coverage as it usually provides in normal operation and some objects might not be seen.

The camera lens for the camera is located on the tailgate. Keep the lens clean so the video image remains clear and undistorted. Clean the lens with a soft, lint-free cloth and non-abrasive cleaner.

Note: If the camera system image is not clear or seems distorted, it may be covered with water droplets, snow, mud or any other substance. If this occurs, clean the camera lens before using the camera system.



WARNING: The camera system is a reverse aid supplement device that still requires the driver to use it in conjunction with the rear view mirror and the side mirrors for maximum coverage.



WARNING: Objects that are close to either corner of the bumper or under the bumper, might not be seen on the screen due to the limited coverage of the camera system.



WARNING: Back up as slow as possible since higher speeds might limit your reaction time to stop the vehicle.



WARNING: Do not use the camera system with the tailgate open.

If the back end of the vehicle is hit or damaged, then check with your authorized dealer to have your rearview camera system checked for proper coverage and operation.

292

Driving

Night time and dark area use

At night time or in dark areas, the camera system relies on the reverse lamp lighting to produce an image. Therefore it is necessary that both reverse lamps are operating in order to get a clear image in the dark. If either of the lamps are not operating, stop using the camera system, at least in the dark, until the lamp(s) are replaced and functioning.

Servicing

- If the image comes on while the vehicle is not in R (Reverse), have the system inspected by your authorized dealer.
- If the image is not clear, then check if there is anything covering the lens such as dirt, mud, ice, snow, etc. If the image is still not clear after cleaning, have your system inspected by your authorized dealer.

FOUR-WHEEL DRIVE (4WD) OPERATION (IF EQUIPPED)



WARNING: For important information regarding safe operation of this type of vehicle, see **Preparing to drive your vehicle** in this chapter.

When four-wheel drive (4WD) is engaged, power is supplied to all four wheels through a transfer case. 4WD can be selected when additional driving power is desired.

4WD operation is not recommended on dry pavement. Doing so could result in difficult disengagement of the transfer case, increased tire wear and decreased fuel economy.

Manual Shift On Stop (MSOS) 4x4 system (if equipped)

The 4WD system is engaged or disengaged by rotating the control for both front wheel hub locks from the FREE or LOCK position, then manually engaging or disengaging the transfer case with the floor-mounted shifter. For increased fuel economy in 2WD, rotate both hub locks to the FREE position.

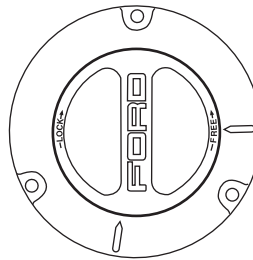

- **For proper operation, make sure that each hub is fully engaged and that both hub locks are set to the same position (both set to LOCK or both set to FREE). To engage LOCK,**

293

Driving

turn the hub locks completely clockwise; to disengage the hubs (FREE), turn the hub locks completely counterclockwise.

- **The vehicle should not be driven in 4X4 High or 4X4 Low modes with the hub locks set to FREE as this condition may damage driveline system components.**
- Some vehicles may be equipped with wheel ornaments that cover the 4x4 manual hub lock. These ornaments must be removed to access the manual hub locks.

Electronic Shift On the Fly (ESOF) 4x4 system (if equipped)

If equipped with the electronic shift 4WD system, and 4X4 Low is selected while the vehicle is moving above 3 mph (5 km/h), the 4WD system will not perform a shift. This is normal and should be no reason for concern. Refer to Shifting to/from 4L (4X4 Low) for proper system operation.

The ESOF 4WD system:

- provides 4x4 High engagement and disengagement while the vehicle is moving.
- is operated by a rotary control located on the instrument panel that allows you select 4x2, 4x4 High or 4x4 Low operation.
- uses auto-manual hub locks that can be engaged and disengaged automatically based on the 4x4 mode selected.
- auto-manual hub locks can be manually overridden by rotating the hub lock control from AUTO to LOCK if desired.
- **automatic operation of the hub locks is recommended**, and will increase fuel economy
- **For proper operation, make sure that each hub is fully engaged and that both hub locks are set to the same position (both set to LOCK or both set to AUTO). To engage LOCK, turn the hub locks completely clockwise; to engage AUTO, turn the hub locks completely counterclockwise.**

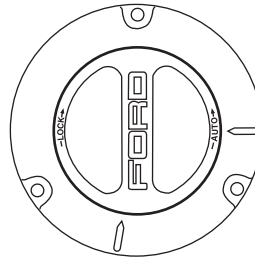

4WD system indicator lights

The indicator lights illuminate in the message center in the reconfigurable telltale (RTT) under the following conditions. Refer to *Warning lights and chimes* in the *Instrument Cluster* chapter.

- **4X2** - Momentarily illuminates when 2H is selected on electronic shift 4WD systems only. **4x2**
- **4X4 HIGH** - Illuminates when 4H (4x4 High) is engaged. **4x4 HIGH**
- **4X4 LOW** - Illuminates when 4L (4x4 Low) is engaged. **4x4 LOW**
- **CHECK 4X4** - Displays when a 4x4 system fault is present

Using a Manual Shift On Stop (MSOS) 4x4 system (if equipped)

Note: High shift efforts may be encountered when attempting to shift into and out of 4x4 modes. It is recommended to allow the vehicle to roll at a speed below 3 mph (5 km/h) when shifting between modes.

Note: Some noise may be heard as the 4x4 system shifts or engages. This is normal. In order to reduce engagement noise, it is recommended that all shifts be performed at speeds below 3 mph (5 km/h).

2H (2WD) – For general on-road driving. Sends power to the rear wheels only should be used for street and highway driving. Provides optimal smoothness and fuel economy at high speeds.

4H (4x4 High) – Used for extra traction such as in snow or icy roads or in off road situations. **This mode is not intended for use on dry pavement.**

N (Neutral) – Only used when towing the vehicle. No power to front or rear wheels.

4L (4x4 Low) – Uses extra gearing to provide maximum power to all four wheels at reduced speeds. Intended only for off road applications such as deep sand, steep grades or pulling heavy objects.

Driving

Shifting from 2H (2WD) to 4H (4x4 High)

Engage the locking hubs by rotating the hub lock control from FREE to LOCK, then move the transfer case lever from 2H (2WD) to 4H (4x4 High) at a stop or a vehicle speed below 3 mph (5 km/h).

- **For proper operation, make sure that both indicator arrows on the hub are aligned, and that both hubs are set to LOCK.**
- **Do not shift into 4H (4x4 High) with the rear wheels slipping.**
- **The vehicle should not be driven in 4X4 High with the hub locks disengaged as this condition may damage driveline system components.**

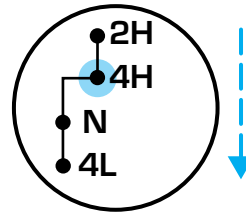
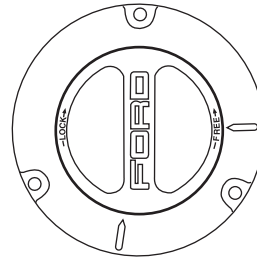

Shifting from 4H (4x4 High) to 2H (2WD)

Move the transfer case lever to 2H (2WD) at a stop or a vehicle speed below 3 mph (5 km/h).

With the vehicle at complete stop, disengage the locking hubs (optional) by rotating the hub lock control from LOCK to FREE.

- **For proper operation, make sure that both indicator arrows on the hub are aligned, and that both hubs are set to FREE.**

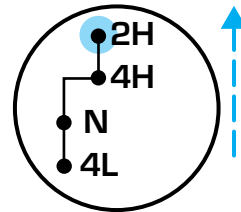

Shifting from 2H (2WD) or 4H (4x4 High) to 4L (4x4 Low)

1. Bring the vehicle to a stop or a speed below 3 mph (5 km/h).
2. Place the transmission in N (Neutral).

Driving

3. Move the transfer case shift lever through N (Neutral) directly to 4L (4x4 Low).

4. If the shift lever does not, or only partially moves to the 4L (4x4 Low) position, perform a shift with the transmission in N (Neutral) and the vehicle rolling at a speed below

3 mph (5 km/h). This will ensure the transfer case is fully engaged into 4L (4x4 Low).

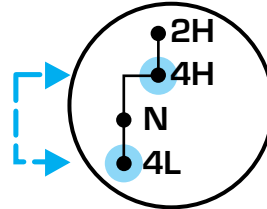

Note: The vehicle should not be driven in 4X4 High with the hub locks disengaged as this condition may damage driveline system components.

Shifting from 4L (4x4 Low) to 4H (4x4 High) or 2H (2WD)

1. Bring the vehicle to a stop or a speed below 3 mph (5 km/h).

2. Place the gearshift lever in N (Neutral).

3. Move the transfer case shift lever through N (Neutral) directly to 4H (4x4 High) or 2H (2WD).

4. If the transfer case **will not** engage into 4H (4x4 High) or 2H (2WD), perform a shift with the transmission in N (Neutral) and the vehicle rolling at a speed below 3 mph (5 km/h).

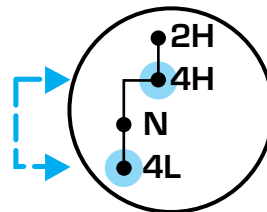

5. If shifting to 2H (2WD) with the vehicle at a complete stop, disengage the locking hubs (optional) by rotating the hub lock control from LOCK to FREE.

Using the N (Neutral) position

The transfer case neutral position overrides the transmission and puts the vehicle in neutral regardless of transmission gearshift lever position. The vehicle can move forward or backwards.

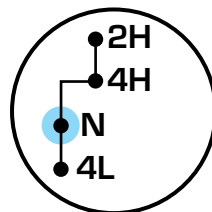

This position should only be used when towing the vehicle.

Driving



WARNING: Do not leave the vehicle unattended with the transfer case in the N (Neutral) position. Always set the parking brake fully and turn off the ignition when leaving the vehicle.

Using the electronic shift 4WD system (if equipped)

2H (2WD) - For general on-road driving. Sends power to the rear wheels only and should be used for street and highway driving. Provides optimal smoothness and fuel economy at high speeds.

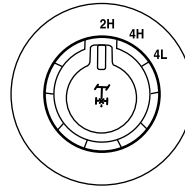

4H (4X4 High) - Used for extra traction such as in snow or icy roads or in off road situations. **This mode is not intended for use on dry pavement.**

4L (4X4 Low) - Uses extra gearing to provide maximum power to all four wheels at reduced speeds. Intended only for off-road applications such as deep sand, steep grades or pulling heavy objects. 4L (4X4 low) will not engage while the vehicle is moving above 3 mph (5 km/h); this is normal and should be no reason for concern. Refer to *Shifting to/from 4L (4X4 low)* for proper operation.

Shifting between 2H (4X2) and 4H (4X4 high)

Move the 4WD control between 2H (4X2) and 4H (4X4 high) at any forward speed. The message center will display **4X4 SHIFT IN PROGRESS** during the system shift. “4X4 HIGH” will display in the message center if 4H is selected and “4X2” will momentarily display in the message center if 2H is selected.

If **SHIFT DELAYED PULL FORWARD** is displayed in the message center during the mode shift, transfer case gear tooth blockage is present. To alleviate this condition, place the transmission in a forward gear and move the vehicle forward approximately 5 feet (2 meters) to allow the transfer case to complete the mode shift.

Note: Momentarily releasing the accelerator pedal while performing a shift will improve engagement/disengagement times.

Note: Do not perform this operation if the rear wheels are slipping.

Note: Some noise may be heard as the system shifts or engages; this is normal.

Note: 4X4 high mode is not intended for use on dry pavement.

298

Shifting to/from 4L (4X4 low)

1. Bring the vehicle to a speed of 3 mph (5 km/h) or less.
2. Place the transmission in N (Neutral).
3. Move the 4WD control to the desired position.

The message center will display **4X4 SHIFT IN PROGRESS** during the shift. The message center will then display the system mode selected. If any of the above shift conditions are not met, the shift will not occur and the message center will display information guiding the driver through the proper shifting procedures.

If **SHIFT DELAYED PULL FORWARD** is displayed in the message center, transfer case gear tooth blockage is present. To alleviate this condition, place the transmission in a forward gear, move the vehicle forward approximately 5 feet (1.5 m), and shift the transmission back to neutral to allow the transfer case to complete the range shift.

Note: Some noise may be heard as the system shifts or engages; this is normal.

Note: 4x4 low mode is not intended for use on dry pavement.

Driving off-road with truck and utility vehicles

4WD vehicles are specially equipped for driving on sand, snow, mud and rough terrain and have operating characteristics that are somewhat different from conventional vehicles, both on and off the road.

Your vehicle may be equipped with a long front air dam that may become damaged (due to reduced ground clearance) when taking your vehicle off-road. This air dam can either be removed or a shorter air dam can be purchased from your authorized dealer. In either case, if the air dam is to be removed (or replaced) before going off-road, refer to the *Workshop Manual* for the procedure or have your authorized dealer perform the work for you.

How your vehicle differs from other vehicles

Truck and utility vehicles can differ from some other vehicles. Your vehicle may be higher to allow it to travel over rough terrain without getting hung up or damaging underbody components.

The differences that make your vehicle so versatile also make it handle differently than an ordinary passenger car.

Maintain steering wheel control at all times, especially in rough terrain. Since sudden changes in terrain can result in abrupt steering wheel motion, make sure you grip the steering wheel from the outside. Do not grip the spokes.

Driving

Drive cautiously to avoid vehicle damage from concealed objects such as rocks and stumps.

You should either know the terrain or examine maps of the area before driving. Map out your route before driving in the area. To maintain steering and braking control of your vehicle, you must have all four wheels on the ground and they must be rolling, not sliding or spinning.

Basic operating principles

- Do not use 4WD on dry, hard surfaced roads. Doing so will produce excessive noise, increase tire wear and may damage drive components. 4WD modes are only intended for consistently slippery or loose surfaces.
- Drive slower in strong crosswinds which can affect the normal steering characteristics of your vehicle.
- Be extremely careful when driving on pavement made slippery by loose sand, water, gravel, snow or ice.

If your vehicle goes off the edge of the pavement

- If your vehicle goes off the edge of the pavement, slow down, but avoid severe brake application, ease the vehicle back onto the pavement only after reducing your speed. Do not turn the steering wheel too sharply while returning to the road surface.
- It may be safer to stay on the apron or shoulder of the road and slow down gradually before returning to the pavement. You may lose control if you do not slow down or if you turn the steering wheel too sharply or abruptly.
- It often may be less risky to strike small objects, such as highway reflectors, with minor damage to your vehicle rather than attempt a sudden return to the pavement which could cause the vehicle to slide sideways out of control or roll over. Remember, your safety and the safety of others should be your primary concern.



WARNING: Vehicles with a higher center of gravity such as utility and four-wheel drive vehicles handle differently than vehicles with a lower center of gravity. Utility and four-wheel drive vehicles are **not** designed for cornering at speeds as high as passenger cars any more than low-slung sports cars are designed to perform satisfactorily under off-road conditions. Avoid sharp turns, excessive speed and abrupt maneuvers in these vehicles. Failure to drive cautiously could result in an increased risk of loss of vehicle control, vehicle rollover, personal injury and death.

If your vehicle gets stuck

If your vehicle gets stuck in mud or snow it may be rocked out by shifting between forward and reverse gears, stopping between shifts, in a steady pattern. Press lightly on the accelerator in each gear.

Do not rock the vehicle if the engine is not at normal operating temperature or damage to the transmission may occur.

Do not rock the vehicle for more than a few minutes or damage to the transmission and tires may occur or the engine may overheat.



WARNING: Do not spin the wheels at over 35 mph (56 km/h). The tires may fail and injure a passenger or bystander.

Refer to *Gauges* in the *Instrument Cluster* chapter for transmission fluid temperature information.

Emergency maneuvers

- In an unavoidable emergency situation where a sudden sharp turn must be made, remember to avoid “over-driving” your vehicle, i.e., turn the steering wheel only as rapidly and as far as required to avoid the emergency. Excessive steering will result in less vehicle control, not more. Additionally, smooth variations of the accelerator and/or brake pedal pressure should be utilized if changes in vehicle speed are called for. Avoid abrupt steering, acceleration or braking which could result in an increased risk of loss of vehicle control, vehicle rollover and/or personal injury. Use all available road surface to return the vehicle to a safe direction of travel.
- In the event of an emergency stop, avoid skidding the tires and do not attempt any sharp steering wheel movements.



WARNING: Vehicles with a higher center of gravity such as utility and four-wheel drive vehicles handle differently than vehicles with a lower center of gravity. Utility and four-wheel drive vehicles are **not** designed for cornering at speeds as high as passenger cars any more than low-slung sports cars are designed to perform satisfactorily under off-road conditions. Avoid sharp turns, excessive speed and abrupt maneuvers in these vehicles. Failure to drive cautiously could result in an increased risk of loss of vehicle control, vehicle rollover, personal injury and death.

Driving

- If the vehicle goes from one type of surface to another (i.e., from concrete to gravel) there will be a change in the way the vehicle responds to a maneuver (steering, acceleration or braking). Again, avoid these abrupt inputs.

Parking

On some 4WD vehicles, when the transfer case is in the N (Neutral) position, the engine and transmission are disconnected from the rest of the driveline. Therefore, the vehicle is free to roll even if the automatic transmission is in P (Park). Do not leave the vehicle unattended with the transfer case in the N (Neutral) position. Always set the parking brake fully and turn off the ignition when leaving the vehicle.



WARNING: Always set the parking brake fully and make sure the gearshift is latched in P (Park). Turn the ignition to the off position and remove the key whenever you leave your vehicle.



WARNING: If the parking brake is fully released, but the brake warning lamp remains illuminated, the brakes may not be working properly. See your authorized dealer.

4WD Systems

4WD (when you select a 4WD mode), uses all four wheels to power the vehicle. This increases traction, enabling you to drive over terrain and road conditions that a conventional two-wheel drive vehicle cannot.

Power is supplied to all four wheels through a transfer case. On 4WD vehicles, the transfer case allows you to select 4WD when necessary. Information on transfer case operation and shifting procedures can be found in the *Driving* chapter. Information on transfer case maintenance can be found in the *Maintenance and Specifications* chapter. You should become thoroughly familiar with this information before you operate your vehicle.

Normal characteristics

On some 4WD models, the initial shift from two-wheel drive to 4x4 while the vehicle is moving can cause some momentary clunk and ratcheting sounds. This is the front drivetrain coming up to speed and the automatic locking hubs engaging and is not cause for concern.

Sand

When driving over sand, try to keep all four wheels on the most solid area of the trail. Avoid reducing the tire pressures but shift to a lower gear and drive steadily through the terrain. Apply the accelerator slowly and avoid spinning the wheels.

Avoid excessive speed because vehicle momentum can work against you and cause the vehicle to become stuck to the point that assistance may be required from another vehicle. Remember, you may be able to back out the way you came if you proceed with caution.

Note: If air is released from your tires, the Tire Pressure Monitoring System (TPMS) indicator light may illuminate (if equipped).

Mud and water

If you must drive through high water, drive slowly. Traction or brake capability may be limited.

When driving through water, determine the depth; avoid water higher than the bottom of the hubs (if possible) and proceed slowly. If the ignition system gets wet, the vehicle may stall.



Once through water, always try the brakes. Wet brakes do not stop the vehicle as effectively as dry brakes. Drying can be improved by moving your vehicle slowly while applying light pressure on the brake pedal.

Be cautious of sudden changes in vehicle speed or direction when you are driving in mud. Even 4WD vehicles can lose traction in slick mud. As when you are driving over sand, apply the accelerator slowly and avoid spinning your wheels. If the vehicle does slide, steer in the direction of the slide until you regain control of the vehicle.

If the transmission, transfer case or front axle are submerged in water, their fluids should be checked and changed, if necessary.

Driving through deep water may damage the transmission.

Refer to *Transmission temperature gauge* in the *Instrument Cluster* chapter for transmission fluid temperature information.

If the front or rear axle is submerged in water, the axle lubricant should be replaced.

After driving through mud, clean off residue stuck to rotating driveshafts and tires. Excess mud stuck on tires and rotating driveshafts causes an imbalance that could damage drive components.

Driving

“Tread Lightly” is an educational program designed to increase public awareness of land-use regulations and responsibilities in our nations wilderness areas. Ford Motor

Company joins the U.S. Forest Service and the Bureau of Land Management in encouraging you to help preserve our national forest and other public and private lands by “treading lightly.”



Driving on hilly or sloping terrain

Although natural obstacles may make it necessary to travel diagonally up or down a hill or steep incline, you should always try to drive straight up or straight down. **Avoid driving crosswise or turning on steep slopes or hills.** A danger lies in losing traction, slipping sideways and possibly rolling over. Whenever driving on a hill, determine beforehand the route you will use. Do not drive over the crest of a hill without seeing what conditions are on the other side. Do not drive in reverse over a hill without the aid of an observer.

When climbing a steep slope or hill, start in a lower gear rather than downshifting to a lower gear from a higher gear once the ascent has started. This reduces strain on the engine and the possibility of stalling.

If you do stall out, do not try to turn around because you might roll over. It is better to back down to a safe location.

Apply just enough power to the wheels to climb the hill. Too much power will cause the tires to slip, spin or lose traction, resulting in loss of vehicle control.

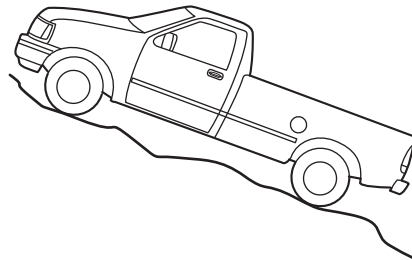

Driving

Descend a hill in the same gear you would use to climb up the hill to avoid excessive brake application and brake overheating. Do not descend in neutral; instead, manually shift to a lower gear. Your vehicle has anti-lock brakes, apply the brakes steadily. Do not “pump” the brakes.

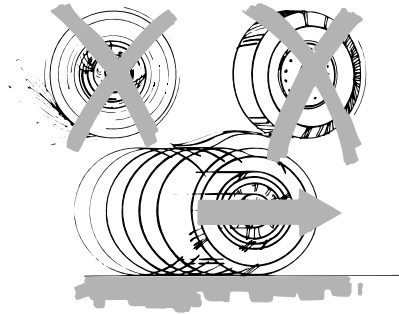

Driving on snow and ice

4WD vehicles have advantages over 2WD vehicles in snow and ice but can skid like any other vehicle.

Should you start to slide while driving on snowy or icy roads, turn the steering wheel in the direction of the slide until you regain control.

Avoid sudden applications of power and quick changes of direction on snow and ice. Apply the accelerator slowly and steadily when starting from a full stop.

Avoid sudden braking as well. Although a 4WD vehicle may accelerate better than a two-wheel drive vehicle in snow and ice, it won't stop any faster, because as in other vehicles, braking occurs at all four wheels. Do not become overconfident as to road conditions.

Make sure you allow sufficient distance between you and other vehicles for stopping. Drive slower than usual and consider using one of the lower gears. In emergency stopping situations, avoid locking of the wheels. Use a “squeeze” technique, push on the brake pedal with a steadily increasing force which allows the wheels to brake yet continue to roll so that you may steer in the direction you want to travel. If you lock the wheels, release the brake pedal and repeat the squeeze technique. If your vehicle is equipped with a Four Wheel Anti-Lock Brake System (ABS), apply the brake steadily. Do not “pump” the brakes. Refer to the *Brakes* section of this chapter for additional information on the operation of the anti-lock brake system.

Driving



WARNING: If you are driving in slippery conditions that require tire cables, then it is critical that you drive cautiously. Keep speeds down, allow for longer stopping distances and avoid aggressive steering to reduce the chances of a loss of vehicle control which can lead to serious injury or death. If the rear end of the vehicle slides while cornering, steer in the direction of the slide until you regain control of the vehicle.

Maintenance and Modifications

The suspension and steering systems on your vehicle have been designed and tested to provide predictable performance whether loaded or empty and durable load carrying capability. For this reason, Ford Motor Company strongly recommends that you do not make modifications such as adding or removing parts (such as lift kits or stabilizer bars) or by using replacement parts not equivalent to the original factory equipment.

Any modifications to a vehicle that raise the center of gravity can make it more likely the vehicle will roll over as a result of a loss of control. Ford Motor Company recommends that caution be used with any vehicle equipped with a high load or device (such as ladder racks or pickup box cover).

Failure to maintain your vehicle properly may void the warranty, increase your repair cost, reduce vehicle performance and operational capabilities and adversely affect driver and passenger safety. Frequent inspection of vehicle chassis components is recommended if the vehicle is subjected to heavy off-road usage.

VEHICLE USED AS A STATIONARY POWER SOURCE

Auxiliary equipment called power take-off, or PTO, is often added to the engine or transmission to operate utility equipment. Examples include a wheel-lift for tow trucks, cranes, tools for construction or tire service, and pumping fluids. PTO applications draw auxiliary horsepower from the powertrain, often while the vehicle is stationary. In this condition, there is limited cooling air flow through the radiator and around the vehicle that normally occurs when a vehicle is moving. The aftermarket PTO system installer, having the most knowledge of the final application, is responsible for determining whether additional chassis heat protection or powertrain cooling is required, and alerting the user to the safe and proper operation.

Driving

Ford Super Duty Vehicles are qualified for use as a stationary or mobile power source, within limits detailed in the *Ford Truck Body Builders Layout Book*, found at www.fleet.ford.com/truckbbas, and through the Ford Truck Body Builders Advisory Service.

For stationary PTO operation of extended duration (beyond 10 minutes), diesel engine is recommended. Further consult your aftermarket PTO installer, since the duration of operation limit for the aftermarket PTO may be less than the vehicle is capable of.

DRIVING THROUGH WATER

If driving through deep or standing water is unavoidable, proceed very slowly especially when the depth is not known. Never drive through water that is higher than the bottom of the wheel rims (for cars) or the bottom of the hubs (for trucks).

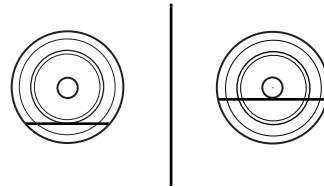

When driving through water, traction or brake capability may be limited. Also, water may enter your engine's air intake and severely damage your engine or your vehicle may stall. **Driving through deep water where the transmission vent tube is submerged may allow water into the transmission and cause internal transmission damage.**

Once through the water, always dry the brakes by moving your vehicle slowly while applying light pressure on the brake pedal. Wet brakes do not stop the vehicle as quickly as dry brakes.

SNOWPLOWING

Ford recommends that the Super Duty F-Series used for snow removal include the Snow Plow Package Option.

Installing the snowplow

Weight limits and guidelines for selecting and installing the snowplow can be found in the *Ford Truck Body Builders Layout Book*, Snowplow section, found at www.fleet.ford.com/truckbbas. A typical installation affects the following:

- Certification to government safety laws such as occupant protection and airbag deployment, braking, and lighting. Look for an "Alterer's Label" on the vehicle from the snowplow installer certifying that the installation meets all applicable Federal Motor Vehicle Safety Standards (FMVSS).

Driving

- The Total Accessory Reserve Capacity (TARC) is shown on the lower right side of the vehicle's Safety Compliance Certification Label. This applies to Ford-completed vehicles of 10,000 lb. (4,536 kg) GVWR or less. This is the weight of permanently-attached auxiliary equipment, such as snowplow frame-mounting hardware, that can be added to the vehicle and satisfy Ford compliance certification to FMVSS. Exceeding this weight may require the auxiliary equipment installer additional safety certification responsibility. The Front Accessory Reserve Capacity (FARC) is added for customer convenience.
- Rear ballast weight behind the rear axle may be required to prevent exceeding the FGAWR, and provide front-to-rear weight balance for proper braking and steering.
- Front wheel toe may require re-adjustment to prevent premature uneven tire wear. Specifications are found in the Ford *Workshop Manual*.
- Headlight aim may require re-adjustment.
- The tire air pressures recommended for general driving are found on the vehicle's Safety Certification Label. The maximum cold inflation pressure for the tire and associated load rating is imprinted on the tire sidewall. Tire air pressure may require re-adjustment within these pressure limits to accommodate the additional weight of the snowplow installation.
- Federal and some local regulations require additional exterior lamps for snowplow-equipped vehicles. Consult your authorized dealer for additional information.

Operating the vehicle with the snowplow attached

Do not use your vehicle for snow removal until it has been driven at least 500 miles (800 km).

The attached snowplow blade restricts airflow to the radiator, and may cause the engine to run at a higher temperature: Attention to engine temperature is especially important when outside temperatures are above freezing. Angle the blade to maximize airflow to the radiator and monitor engine temperature to determine whether a left or right angle provides the best performance.

Follow the severe duty schedule in your *scheduled maintenance information* for engine oil and transmission fluid change intervals.

Driving

Snowplowing with your airbag-equipped vehicle

Your vehicle is equipped with a driver and passenger airbag Supplemental Restraint System (SRS). The SRS is designed to activate in certain frontal and offset frontal collisions when the vehicle sustains sufficient longitudinal deceleration.

Careless or high speed driving while plowing snow which results in sufficient vehicle decelerations can deploy the airbag. Such driving also increases the risk of accidents.

 **WARNING:** All occupants of the vehicle, including the driver, should always properly wear their safety belts, even when an air bag supplemental restraint system (SRS) is provided.

Never remove or defeat the “tripping mechanisms” designed into the snow removal equipment by its manufacturer. Doing so may cause damage to the vehicle and the snow removal equipment as well as possible airbag deployment.

 **WARNING:** Do not attempt to service, repair, or modify the air bag supplemental restraint system (SRS) or its fuses. See your Ford or Lincoln Mercury dealer.

 **WARNING:** Additional equipment such as snowplow equipment may effect the performance of the airbag sensors increasing the risk of injury. Please refer to the *Body Builders Layout Book* for instructions about the appropriate installation of additional equipment.

Transmission operation while plowing

Operate the vehicle with the automatic transmission gearshift lever in the D (Overdrive) position and tow/haul off.

- Shift transfer case to 4L (4x4 Low) when plowing in small areas at speeds below 5 mph (8 km/h).
- Shift transfer case to 4H (4x4 High) when plowing larger areas or light snow at higher speeds. Do not exceed 15 mph (24 km/h).
- Do not shift the transmission from a forward gear to R (Reverse) until the engine is at idle and the wheels are stopped.
- If the vehicle is stuck, shift the transmission in a steady motion between forward and reverse gears. Do not rock the vehicle for more than a few minutes. The transmission and tires may be damaged or the engine can overheat.

Driving

Do not rock the vehicle if the engine is not at normal operating temperature. Do not rock the vehicle for more than a minute. The transmission and tires may be damaged or the engine may overheat.

Refer to *Gauges* in the *Instrument Cluster* chapter for transmission fluid temperature information.



WARNING: Do not spin the wheels at over 35 mph (55 km/h). The tires may fail and injure a passenger or bystander.

Roadside Emergencies

ROADSIDE ASSISTANCE

Getting roadside assistance

To fully assist you should you have a vehicle concern, Ford Motor Company offers a complimentary roadside assistance program. This program is separate from the New Vehicle Limited Warranty. The service is available:

- 24-hours, seven days a week
- for the coverage period listed on the Roadside Assistance Card included in your Owner Guide portfolio.

Roadside assistance will cover:

- a flat tire change with a good spare (except vehicles that have been supplied with a tire inflation kit)
- battery jump start
- lock-out assistance (key replacement cost is the customer's responsibility)
- fuel delivery – Independent Service Contractors, if not prohibited by state, local or municipal law shall deliver up to 2.0 gallons (7.5L) of gasoline or 5.0 gallons (18.9L) of diesel fuel to a disabled vehicle. Fuel delivery service is limited to two no-charge occurrences within a 12-month period.
- winch out – available within 100 feet (30.5 meters) of a paved or county maintained road, no recoveries.
- towing – Ford/Mercury/Lincoln eligible vehicle towed to an authorized dealer within 35 miles (56 km) of the disablement location or to the nearest authorized dealer. If a member requests to be towed to an authorized dealer more than 35 miles (56 km) from the disablement location, the member shall be responsible for any mileage costs in excess of 35 miles (56 km).

Trailers shall be covered up to \$200 if the disabled eligible vehicle requires service at the nearest authorized dealer. If the trailer is disabled, but the towing vehicle is operational, the trailer does not qualify for any roadside services.

DEF or Diesel Exhaust Fluid is available at most Ford or Lincoln Mercury Dealers. To locate a local dealer you may do so via the following options: via the internet www.dealerconnection.com, or call the Ford Roadside Assistance center at 1-800-241-3673 or via the Department of Energy's website to find other retailers <http://www.afdc.energy.gov/afdc/locator/def>.

Roadside Emergencies

Canadian customers refer to your Warranty Guide or visit our website at www.ford.ca for information on:

Using roadside assistance

Complete the roadside assistance identification card and place it in your wallet for quick reference. In the United States, this card is found in the Owner Guide portfolio in the glove compartment. In Canada, the card is found in the *Warranty Guide* in the glove compartment.

U.S. Ford, Mercury and Lincoln vehicle customers who require Roadside Assistance, call 1-800-241-3673.

Canadian customers who require roadside assistance, call 1-800-665-2006.

If you need to arrange roadside assistance for yourself, Ford Motor Company will reimburse a reasonable amount for towing to the nearest dealership within 35 miles (56 km). To obtain reimbursement information, U.S. Ford, Mercury and Lincoln vehicle customers call 1-800-241-3673. Customers will be asked to submit their original receipts.

Canadian customers who need to obtain reimbursement information, call 1-800-665-2006 or visit our website at www.ford.ca.

HAZARD FLASHER CONTROL

The hazard flasher is located on the steering column, just behind the steering wheel. The hazard flashers will operate when the ignition is in any position or if the key is not in the ignition.

Press in the flasher control and all front and rear direction signals will flash. Press the flasher control again to turn them off. Use it when your vehicle is disabled and is creating a safety hazard for other motorists.

Note: With extended use, the flasher may run down your battery.

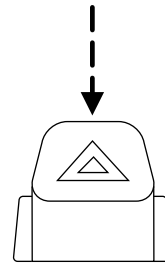

Roadside Emergencies

FUEL PUMP SHUT-OFF

In the event of a moderate to severe collision, this vehicle is equipped with a fuel pump shut-off feature that stops the flow of fuel to the engine. Not every impact will cause a shut-off.

Should your vehicle shut off after a collision due to this feature, you may restart your vehicle by doing the following:

1. Turn the ignition switch to the off position.
2. Turn the ignition switch to the on position.

In some instances the vehicle may not restart the first time you try to restart and may take one additional attempt.



WARNING: Failure to inspect and if necessary repair fuel leaks after a collision may increase the risk of fire and serious injury. Ford Motor Company recommends that the fuel system be inspected by an authorized dealer after any collision.

FUSES AND RELAYS

Fuses

If electrical components in the vehicle are not working, a fuse may have blown. Blown fuses are identified by a broken wire within the fuse. Check the appropriate fuses before replacing any electrical components.

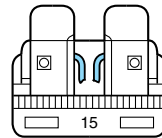

Note: Always replace a fuse with one that has the specified amperage rating. Using a fuse with a higher amperage rating can cause severe wire damage and could start a fire.

Roadside Emergencies

Standard fuse amperage rating and color

Fuse rating	COLOR				
	Mini fuses	Standard fuses	Maxi fuses	Cartridge maxi fuses	Fuse link cartridge
2A	Grey	Grey	—	—	—
3A	Violet	Violet	—	—	—
4A	Pink	Pink	—	—	—
5A	Tan	Tan	—	—	—
7.5A	Brown	Brown	—	—	—
10A	Red	Red	—	—	—
15A	Blue	Blue	—	—	—
20A	Yellow	Yellow	Yellow	Blue	Blue
25A	Natural	Natural	—	—	—
30A	Green	Green	Green	Pink	Pink
40A	—	—	Orange	Green	Green
50A	—	—	Red	Red	Red
60A	—	—	Blue	Yellow	Yellow
70A	—	—	Tan	—	Brown
80A	—	—	Natural	Black	Black

Passenger compartment fuse panel

The fuse panel is located in the passenger's footwell. Remove the panel cover to access the fuses.

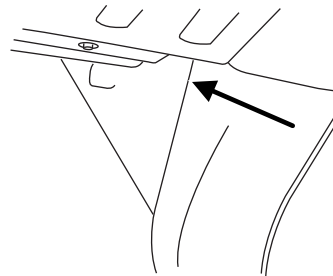

Roadside Emergencies

To remove the fuse panel cover, pull the panel toward you. When the clips of the panel disengage, let the panel fall easily.

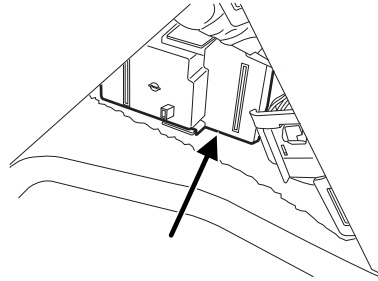

To remove a fuse use the fuse puller tool provided on the fuse panel cover.

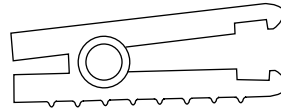

WARNING: Always disconnect the battery before servicing high current fuses.

Always replace the cover to the passenger compartment fuse panel before reconnecting the battery.

If the battery has been disconnected and reconnected, refer to the *Battery* section of the *Maintenance and Specifications* chapter.

Roadside Emergencies

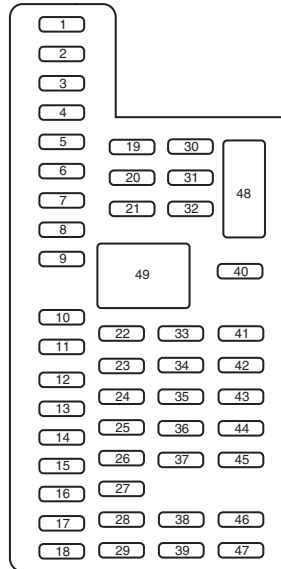

The fuses are coded as follows.

Fuse/Relay Location	Fuse Amp Rating	Protected Circuits
1	30A	Not used (spare)
2	15A	Upfitter relay #4
3	30A	Not used (spare)
4	10A	Telescoping mirror switch, Interior lights, Hood lamp
5	20A	Moon roof
6	5A	Driver seat module
7	7.5A	Driver seat switch, Driver lumbar motor
8	10A	Power mirror switch
9	10A	Upfitter relay #3
10	10A	Run/accessory relay, Customer access feed

Roadside Emergencies

Fuse/Relay Location	Fuse Amp Rating	Protected Circuits
11	10A	Instrument cluster
12	15A	Interior lighting, Lighted running board lamps
13	15A	Right turn signals and brake lamps, Right trailer tow (TT) stop turn relay
14	15A	Left turn signals and brake lamps, Left TT stop turn relay
15	15A	High-mounted stop lamps, Backup lamps, TT backup relay
16	10A	Right low beam headlamp
17	10A	Left low beam headlamp
18	10A	Keypad illumination, Passive anti-theft indicator (PATS), Powertrain control module (PCM), Brake shift interlock
19	20A	Subwoofer
20	20A	Power door locks
21	10A	Brake on/off switch
22	20A	Horn
23	15A	Not used (spare)
24	15A	Steering wheel control module, Diagnostic connector, Satellite radio module, Power fold mirror relay, Remote keyless entry
25	15A	Not used (spare)
26	5A	Steering wheel control module
27	20A	Amplifier
28	15A	Ignition switch
29	20A	SYNC®, GPS module, Radio faceplate

Roadside Emergencies

Fuse/Relay Location	Fuse Amp Rating	Protected Circuits
30	15A	Parking lamp relay, TT parking lamp relay
31	5A	Trailer brake controller (brake signal), Customer access
32	15A	Moon roof, Auto dimming mirrors, Power inverter, Driver and passenger door lock switch illumination
33	10A	Restraint control module
34	10A	Not used (spare)
35	5A	Select shift switch, Reverse park aid module, Trailer brake control module
36	10A	Fuel tank select switch
37	10A	PTC heater
38	10A	Radio faceplate
39	15A	High beam headlamps
40	10A	Parking lamps (in mirrors), Roof marker lamps
41	7.5A	Passenger airbag deactivation indicator
42	5A	Not used (spare)
43	10A	Wiper relay
44	10A	Upfitter switches
45	5A	Not used (spare)
46	10A	Climate control
47	15A	Fog lamps, Fog lamp indicator (in switch)
48	30A Circuit Breaker	Power windows switch, Power rear sliding window switch
49	Relay	Delayed accessory

Roadside Emergencies

Power distribution box

The power distribution box is located in the engine compartment. The power distribution box contains high-current fuses that protect your vehicle's main electrical systems from overloads.



WARNING: Always disconnect the battery before servicing high current fuses.



WARNING: To reduce risk of electrical shock, always replace the cover to the power distribution box before reconnecting the battery or refilling fluid reservoirs.

If the battery has been disconnected and reconnected, refer to the *Battery* section of the *Maintenance and Specifications* chapter.

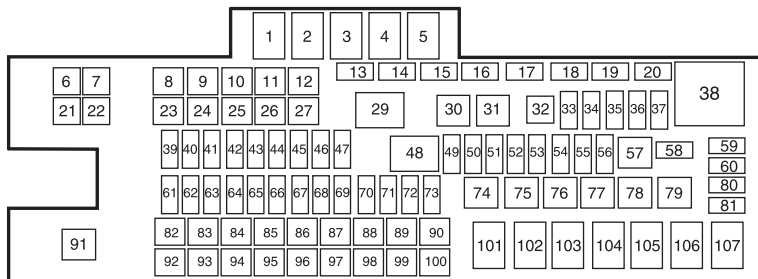

The high-current fuses are coded as follows:

Fuse/Relay Location	Fuse Amp Rating	Protected Circuits
1	Relay	Blower motor
2	—	Not used
3	Relay	Urea heaters
4	—	Not used
5	Relay	Rear window defroster
6	—	Not used
7	40A*	Rear window defroster
8	30A*	Passenger seat

Roadside Emergencies

Fuse/Relay Location	Fuse Amp Rating	Protected Circuits
9	30A*	Driver seat
10	—	Not used
11	—	Not used
12	—	Not used
13	—	Not used
14	—	Not used
15	Diode	Fuel pump
16	—	Not used
17	15A**	Heated mirror
18	—	Not used
19	—	Not used
20	—	Not used
21	—	Not used
22	30A*	Trailer tow electric brake
23	40A*	Blower motor
24	—	Not used
25	30A*	Wipers
26	30A*	Trailer tow park lamps
27	25A*	Urea heaters
28	—	Buss bar
29	Relay	Trailer tow park lamps
30	Relay	A/C clutch
31	Relay	Wipers
32	—	Not used
33	15A**	Vehicle power (VPWR) 1
34	15A**	VPWR 2 (diesel engine)
	20A**	VPWR 2 (gas engine)
35	10A**	VPWR 3
36	15A**	VPWR 4 (diesel engine)
	20A**	VPWR 4 (gas engine)
37	10A**	VPWR 5 (diesel engine)

Roadside Emergencies

Fuse/Relay Location	Fuse Amp Rating	Protected Circuits
38	Relay	Powertrain control module (PCM) (diesel engine), Electronic control module (ECM) (gas engine)
39	10A**	4x4 hub lock
40	15A**	4x4 electronic lock
41	—	Not used
42	—	Not used
43	—	Not used
44	—	Not used
45	10A**	Run/start relay coil
46	10A**	Transmission control module (TCM) keep-alive power
47	10A**	A/C clutch feed
48	Relay	Run/start
49	10A**	Rearview camera system
50	10A**	Blower motor relay coil
51	—	Not used
52	10A**	PCM/ECM/TCM run/start
53	10A**	4x4 module
54	10A**	Anti-lock brake system (ABS) run/start
55	10A**	Rear window defroster coil, Battery charge coil
56	20A**	Passenger compartment fuse panel run/start feed
57	Relay	Fuel pump
58	—	Not used
59	—	Not used
60	—	Not used
61	—	Not used
62	—	Not used

Roadside Emergencies

Fuse/Relay Location	Fuse Amp Rating	Protected Circuits
63	—	Not used
64	—	Not used
65	—	Not used
66	20A**	Fuel pump
67	—	Not used
68	10A**	Fuel pump relay coil
69	—	Not used
70	10A**	Trailer tow backup lamp
71	10A**	Canister vent (gas engine)
72	10A**	PCM/ECM relay coil feed keep-alive power
73	—	Not used
74	Relay	Trailer tow left-hand stop/turn
75	Relay	Trailer tow right-hand stop/turn
76	Relay	Backup lamp
77	—	Not used
78	—	Not used
79	—	Not used
80	—	Not used
81	—	Not used
82	20A*	Auxiliary power point #2
83	20A*	Auxiliary power point #1
84	30A*	4x4 shift motor
85	30A*	Heated/cooled seats
86	25A*	ABS coil feed
87	20A*	Auxiliary power point #5
88	—	Not used
89	40A*	Starter motor
90	25A*	Trailer tow battery charge
91	—	Not used
92	20A*	Auxiliary power point #4

Roadside Emergencies

Fuse/Relay Location	Fuse Amp Rating	Protected Circuits
93	20A*	Auxiliary power point #3
94	25A*	Upfitter #1
95	25A*	Upfitter #2
96	50A*	ABS pump
97	40A*	Invertor
98	—	Not used
99	—	Not used
100	25A*	Trailer tow turn signals
101	Relay	Starter
102	Relay	Trailer tow battery charge
103	—	Not used
104	—	Not used
105	—	Not used
106	—	Not used
107	—	Not used

* Cartridge fuses ** Mini fuses

CHANGING THE TIRES

If you get a flat tire while driving, do not apply the brake heavily. Instead, gradually decrease your speed. Hold the steering wheel firmly and slowly move to a safe place on the side of the road.

Note: If your vehicle is equipped with the tire pressure monitoring system (TPMS), the indicator light will illuminate when the spare tire is in use. To restore the full functionality of the monitoring system, all road wheels equipped with tire pressure monitoring sensors must be mounted on the vehicle.

If your vehicle is equipped with TPMS, have a flat serviced by an authorized dealer in order to prevent damage to the TPMS sensors, refer to *Tire pressure monitoring system (TPMS)* in the *Tires, Wheels and Loading* chapter.



WARNING: The use of tire sealants may damage your tire pressure monitoring system (TPMS) and should not be used. However, if you must use a sealant, the TPMS sensor and valve stem on the wheel must be replaced by an authorized Ford dealer.

Roadside Emergencies



WARNING: Refer to *Tire pressure monitoring system (TPMS)* in the *Tires, Wheels and Loading* chapter for important information. If the tire pressure monitor sensor becomes damaged, it will no longer function.

Dissimilar spare tire/wheel information



WARNING: Failure to follow these guidelines could result in an increased risk of loss of vehicle control, injury or death.

If you have a dissimilar spare tire/wheel, then it is intended for temporary use only. This means that if you need to use it, you should replace it as soon as possible with a road tire/wheel that is the same size and type as the road tires and wheels that were originally provided by Ford. If the dissimilar spare tire or wheel is damaged, it should be replaced rather than repaired.

A dissimilar spare tire/wheel is defined as a spare tire and/or wheel that is different in brand, size or appearance from the road tires and wheels and can be one of three types:

1. **T-type mini-spare:** This spare tire begins with the letter “T” for tire size and may have “Temporary Use Only” molded in the sidewall
2. **Full-size dissimilar spare with label on wheel:** This spare tire has a label on the wheel that states: “THIS TIRE AND WHEEL FOR TEMPORARY USE ONLY”

When driving with one of the dissimilar spare tires listed above, **do not:**

- Exceed 50 mph (80 km/h)
- Load the vehicle beyond maximum vehicle load rating listed on the Safety Compliance Label
- Use snow chains on the end of the vehicle with the dissimilar spare tire
- Use more than one dissimilar spare tire at a time
- Use commercial car washing equipment
- Try to repair the dissimilar spare tire

Use of one of the dissimilar spare tires listed above at any one wheel location can lead to impairment of the following:

- Handling, stability and braking performance
- Comfort and noise

324

Roadside Emergencies

- Ground clearance and parking at curbs
- Winter weather driving capability
- Wet weather driving capability

It is not recommended that the vehicle be operated in 4WD modes with a temporary emergency spare tire. If 4WD operation is necessary, do not operate above speeds of 10 mph (16 km/h) or for distances above 50 miles (80 km).

3. Full-size dissimilar spare without label on wheel

When driving with the full-size dissimilar spare tire/wheel, **do not:**

- Exceed 70 mph (113 km/h)
- Use more than one dissimilar spare tire/wheel at a time
- Use commercial car washing equipment
- Use snow chains on the end of the vehicle with the dissimilar spare tire/wheel

The usage of a full-size dissimilar spare tire/wheel can lead to impairment of the following:

- Handling, stability and braking performance
- Comfort and noise
- Ground clearance and parking at curbs
- Winter weather driving capability
- Wet weather driving capability
- All-Wheel driving capability (if applicable)
- Load leveling adjustment (if applicable)

When driving with the full-size dissimilar spare tire/wheel additional caution should be given to:

- Towing a trailer
- Driving vehicles equipped with a camper body
- Driving vehicles with a load on the cargo rack

Drive cautiously when using a full-size dissimilar spare tire/wheel and seek service as soon as possible.

Roadside Emergencies

Spare tire information

Note: If your vehicle is equipped the tire pressure monitoring system (TPMS), the system indicator light will illuminate when the spare is in use. To restore the full functionality of the TPMS system, all road wheels equipped with the tire pressure monitoring sensors must be mounted on the vehicle.

If your vehicle is equipped with TPMS, have a flat tire serviced by an authorized dealer in order to prevent damage to the TPMS sensor; refer to *Tire Pressure Monitoring System (TPMS)* in the *Tires, Wheel and Loading* chapter. Replace the spare tire with the road tire as soon as possible.

Stopping and securing the vehicle

 **WARNING:** To help prevent the vehicle from moving when you change a tire, be sure the parking brake is set, then block (in both directions) the wheel that is diagonally opposite to the tire being changed.

Refer to the instruction sheet (located under the jack tool kit) for detailed tire change instructions.

Park on a level surface, activate hazard flashers and set the parking brake.

- Automatic transmission: Place gearshift lever in P (Park).
- Manual or electronic shift 4x4: Place transfer case in 4H or 4L.

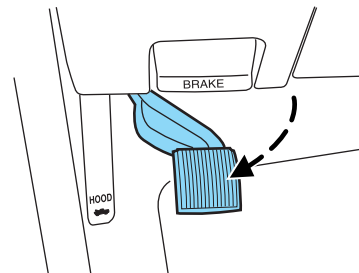

Roadside Emergencies

Location of the spare tire and tools

If your vehicle is equipped with a spare tire, jack and associated tools, refer to the following table for their locations:

Tool	Location
Spare tire (pick-up trucks only)	Under the vehicle, just forward of the rear bumper
Jack	Regular cab and Crew Cab: Fastened to floor pan behind rearmost seat on passenger side SuperCab: Under rear bench seat on passenger side
Jack handle, lug wrench, lug wrench extension (only available on Dual Rear Wheel [DRW] vehicles) and wheel chock (only available on Single Rear Wheel [SRW] vehicles equipped with a diesel engine)	Regular cab: Fastened to floor behind driver seat SuperCab: Fastened to floor under rear seat Crew Cab: Fastened to floor behind rear seat at driver side
Key and spare tire lock	In the glove box
Jack instruction sheet	Under the jack tool kit

Removing the spare tire (with spare tire carrier only)

1. The following tools are required to remove the spare tire:

- one handle extension and two typical extensions. To assemble, align button with hole and slide parts together. To disconnect, depress button and pull apart.
- one wheel nut wrench. Slide over square end of jack handle.

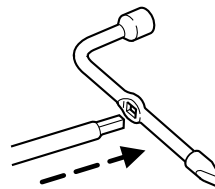
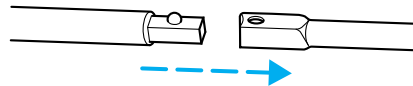

Roadside Emergencies

- **Vehicles equipped with dual rear wheels**, insert the lug wrench extension into the lug wrench to reach the lug nuts.

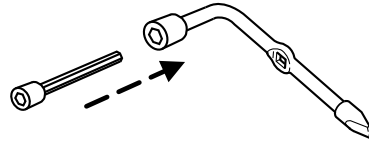

2. Attach the spare tire lock key (A) to the jack handle (B).

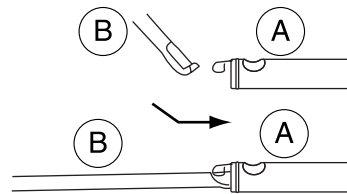

3. Fully insert the jack handle (with one extension) through the bumper hole and into the guide tube. The key and lock will engage with a slight push and counterclockwise turn. Some resistance will be felt when turning the jack handle assembly.

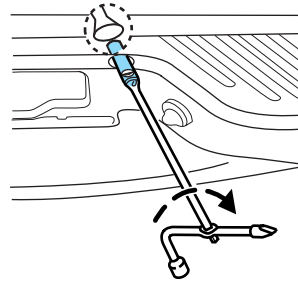

4. Turn the handle counterclockwise and lower the spare tire until you can slide the tire rearward and the cable is slack.
5. Remove the retainer through the center of the wheel.

Roadside Emergencies

If equipped with a tether, perform the following additional steps:

6. Lift the spare tire on end to access the tether attachment.

7. Use the lug wrench to remove the lug nut from the spare tire tether.

8. If not replacing the spare or flat tire to the underbody storage area, raise the wheel retainer up into the installed position.

9. Use the attached fastener strap (on the spare tire tether) to attach the tether end to the winch retainer prior to raising to the installed position.

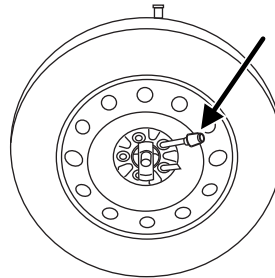

Tire change procedure



WARNING: When one of the rear wheels is off the ground, the transmission alone will not prevent the vehicle from moving or slipping off the jack, even if the transmission is in P (Park).



WARNING: To prevent the vehicle from moving when you change a tire, be sure the parking brake is set, then block (in both directions) the wheel that is diagonally opposite (other side and end of the vehicle) to the tire being changed.



WARNING: If the vehicle slips off the jack, you or someone else could be seriously injured.



WARNING: Do not attempt to change a tire on the side of the vehicle close to moving traffic. Pull far enough off the road to avoid the danger of being hit when operating the jack or changing the wheel.

Note: Passengers should not remain in the vehicle when the vehicle is being jacked.

Roadside Emergencies

1. Turn engine off and block the wheel that is diagonally opposite of the flat tire using the wheel chock, if equipped. **If the vehicle is a 4x4**, lock the manual hub on the wheel.

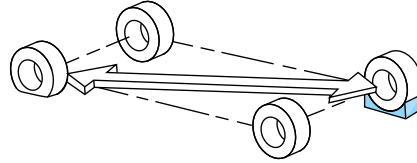

2. Remove the jack, jack handle, lug wrench and spare tire from the stowage locations.

3. Use the tip of the lug wrench to remove any wheel trim.

4. Loosen each wheel lug nut one-half turn counterclockwise but do not remove them until the wheel is raised off the ground.

The following steps apply to F-250/F-350 Single Rear Wheel (SRW) vehicles only:

5. Insert the hooked end of the jack handle into the jack and use the handle to slide the jack under the vehicle.

6. Position the jack according to the following guides:

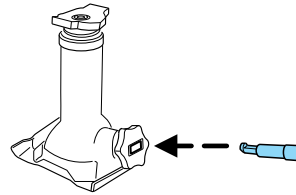

- Front (4x2)

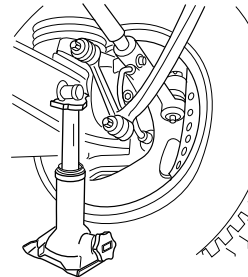

Roadside Emergencies

- Front driver side (4x4)

Note: Make sure the jack fits onto the flat area on the outboard side of the differential.

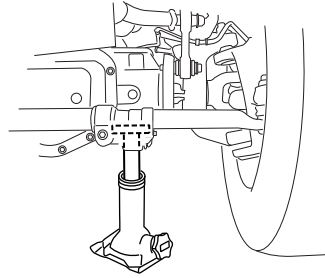

- Front passenger side (4x4)

Note: View shown from the rear of the vehicle to clearly identify the jack point. Place the jack directly under the axle.

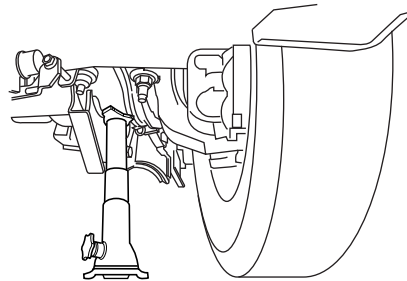

- Rear

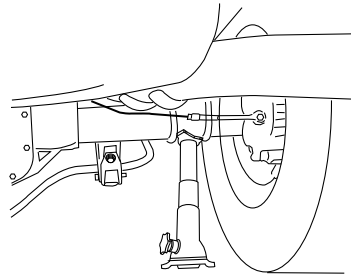

Roadside Emergencies

Never use the front or rear differential as a jacking point.

 **WARNING:** To lessen the risk of personal injury, do not put any part of your body under the vehicle while changing a tire. Do not start the engine when your vehicle is on the jack. The jack is only meant for changing the tire.

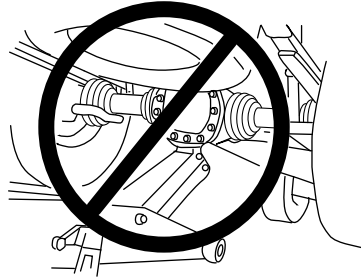

7. Turn the jack handle clockwise until the wheel is completely off the ground and high enough to install the spare tire.

8. Remove the lug nuts with the lug wrench.

9. Replace the flat tire with the spare tire, making sure the valve stem is facing outward for all front wheels and single rear wheel vehicles. If replacing an inboard rear tire on dual rear wheel vehicles, the valve stem must be facing outward. If replacing the outboard wheel, the valve stem must be facing inward. Reinstall the lug nuts until the wheel is snug against the hub. Do not fully tighten the lug nuts until the wheel has been lowered.

10. Lower the wheel by turning the jack handle counterclockwise.

Go to Step 19.

The following steps apply to F-350 Dual Rear Wheel (DRW) and F-450/F-550 vehicles only:

11. Slide the notched end of the jack handle over the release valve and use the handle to slide the jack under the vehicle. Make sure the valve is closed by turning it clockwise.

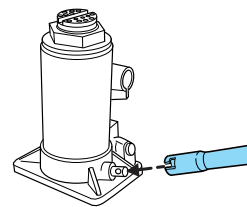
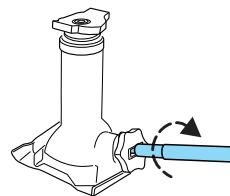

Roadside Emergencies

12. Position the jack according to the following guides:

- Front (4x2): F-350 DRW

Note: Place jack directly under I-beam.

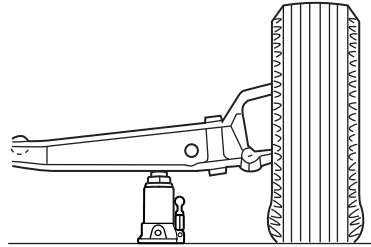

- Front driver side (4x4): F-350 DRW

Note: Make sure the jack fits onto the flat area on the outboard side of the differential housing.

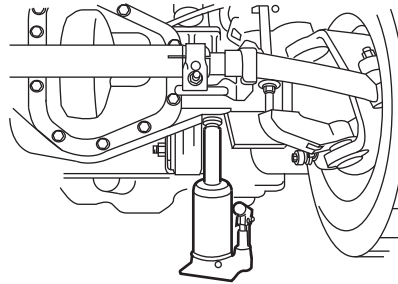

- Front passenger side (4x4): F-350 DRW

Note: View shown from the rear of the vehicle to clearly identify the jack point.

Note: Place the jack directly under axle and inboard of the radius arm so that the jack clears the radius arm.

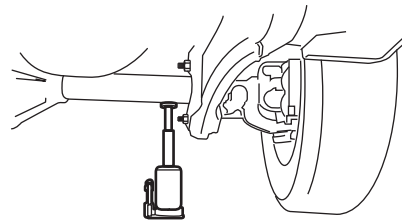

Roadside Emergencies

- Front: F-450/F-550

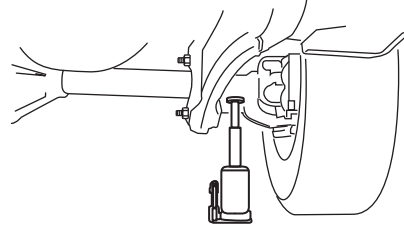

- Rear: F-350 DRW

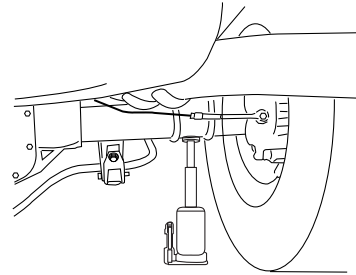

- Rear: F-450/F-550

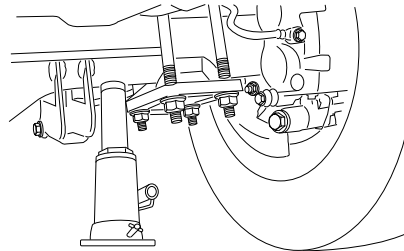

13. Insert the jack handle into the pump linkage.

14. Use an up-and-down motion with the jack handle to raise the wheel completely off the ground.

Hydraulic jacks are equipped with a pressure release valve that prevents lifting loads which exceed the jack's rated capacity.

15. Remove the lug nuts with the lug wrench.

334

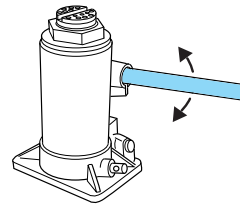

Roadside Emergencies

16. Replace the flat tire with the spare tire, making sure the valve stem is facing outward on all front and inboard rear wheels. If replacing the outboard wheel, the valve stem must be facing inward. Reinstall the lug nuts until the wheel is snug against the hub. Do not fully tighten the lug nuts until the wheel has been lowered.

17. Lower the wheel by slowly turning the release valve counterclockwise. Opening the release valve slowly will provide a more controlled rate of descent.

The following steps apply to all vehicles:

18. Remove the jack and fully tighten the lug nuts in the order shown. Refer to *Wheel lug nut torque specifications* later in this chapter for the proper lug nut torque specification.

8-lug nut torque sequence

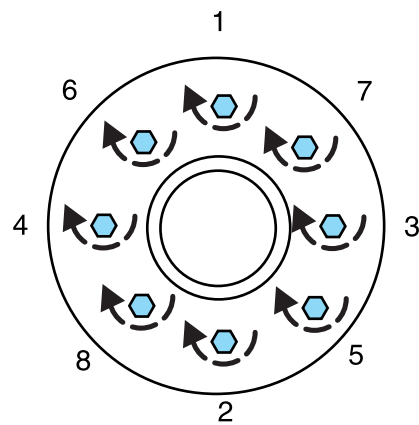

10-lug nut torque sequence

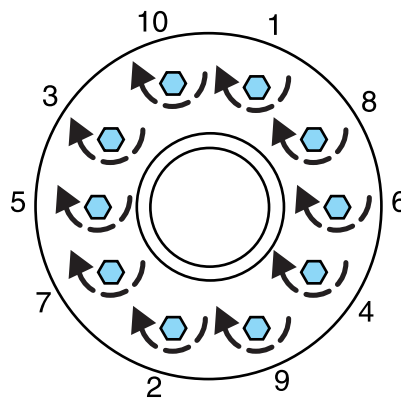

Roadside Emergencies

19. Stow the flat tire. Refer to *Stowing the flat/spare tire* if the vehicle is equipped with a spare tire carrier.

20. Stow the jack, jack handle and lug wrench. Make sure the jack is securely fastened so it does not rattle when driving.

21. Unblock the wheels.

The following step applies to F-250/F-350 Single Rear Wheel (SRW) vehicles only:

22. When installing the wheel center ornaments, ensure that the ornament retention towers on the back side of the ornament are aligned with the studs/lug nuts. The retention towers are designed to be installed over the studs/nuts and retain to the flange on the lug nut.

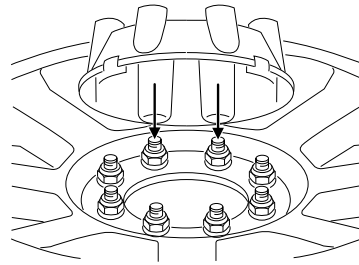

If the ornament retention towers are aligned between the studs/lug nuts, the ornament is improperly installed. This improper installation may appear and sound correct, but will not keep the ornament on the vehicle. Ornaments improperly installed in this manner will fall off or become loose with minimal force or impact.

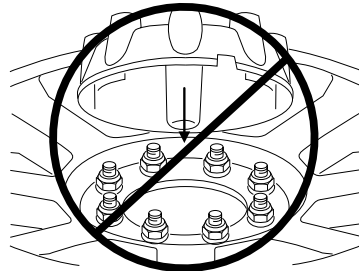

Installing dual rear wheel ornaments

1. Align the ornament with the lug nuts.

- (1) is the clip and (2) is the flange.

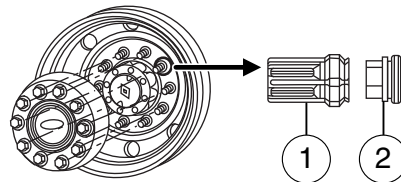

Roadside Emergencies

2. Hold the ornament so that all of the retention clips are sitting on the flange of the lug nuts.

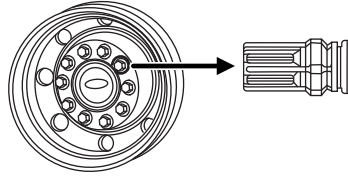

3. Use your hand or rubber mallet to tap the ornament in a star pattern. There should be an even gap between the ornament and the wheel.

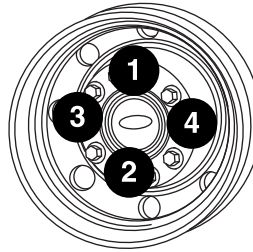

4. Be sure to install all the clips on the nuts over the flanges so that there is an even gap all around and the retention clips are fully seated.

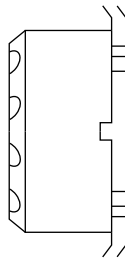
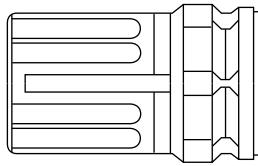

Roadside Emergencies

Stowing the flat/spare tire

Note: Failure to follow spare tire stowage instructions may result in failure of cable or loss of spare tire.

If you are stowing a tire that requires reattaching it to the vehicle with a tether, perform these steps first, then proceed with the steps following.

1. Place the tire on end with the valve stem facing toward the front of the vehicle.
2. Place the tether into the bolt holes in the wheel and attach the lug nut using the lug winch.

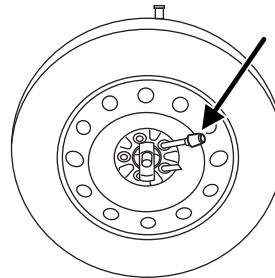

3. Lay the tire on the ground with the valve stem facing in the direction specified on the tire changing instructions located with the jack and tools.
4. Slide the wheel partially under the vehicle and install the retainer through the wheel center. Pull on the cable to align the components at the end of the cable.
5. Turn the jack handle clockwise until the tire is raised to its stowed position underneath the vehicle. The effort to turn the jack handle increases significantly and the spare tire carrier ratchets or slips when the tire is raised to the maximum tightness. Tighten to the best of your ability, to the point where the ratchet/slip occurs, if possible. The spare tire carrier will not allow you to overtighten. If the spare tire carrier ratchets or slips with little effort, take the vehicle to your authorized dealer for assistance at your earliest convenience.
6. Check that the tire lies flat against the frame and is properly tightened. Try to push or pull, then turn the tire to be sure it will not move. Loosen and retighten, if necessary. Failure to properly stow the spare tire may result in failure of the winch cable and loss of the tire.
7. Repeat this tightness check procedure when servicing the spare tire pressure (every six months, per *scheduled maintenance information*), or at any time that the spare tire is disturbed through service of other components.
8. If removed, install the spare tire lock (if equipped) into the bumper drive tube with the spare tire lock key (if equipped) and jack handle.

338

Roadside Emergencies

WHEEL LUG NUT TORQUE SPECIFICATIONS

On vehicles equipped with single rear wheels, retighten the lug nuts to the specified torque at 500 miles (800 km) after any wheel disturbance (tire rotation, changing a flat tire, wheel removal, etc.).

On vehicles equipped with dual rear wheels, retighten the wheel lug nuts to the specified torque at 100 miles (160 km), and again at 500 miles (800 km) of new vehicle operation and after any wheel disturbance (tire rotation, changing a flat tire, wheel removal, etc.).

Bolt size	Wheel lug nut torque*	
	ft-lb	N•m
M14 x 1.5	165	224

* Torque specifications are for nut and bolt threads free of dirt and rust. Use only Ford recommended replacement fasteners.

It is important to follow the proper wheel mounting and lug nut torque procedures.

On all two-piece flat wheel nuts, apply one drop of motor oil between the flat washer and the nut.

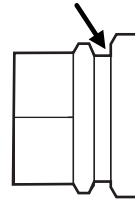

WARNING: When a wheel is installed, always remove any corrosion, dirt or foreign materials present on the mounting surfaces of the wheel or the surface of the wheel hub, brake drum or brake disc that contacts the wheel. Ensure that any fasteners that attach the rotor to the hub are secured so they do not interfere with the mounting surfaces of the wheel. Installing wheels without correct metal-to-metal contact at the wheel mounting surfaces can cause the wheel nuts to loosen and the wheel to come off while the vehicle is in motion, resulting in loss of control.

Roadside Emergencies

Inspect the wheel pilot hole prior to installation. If there is visible corrosion in wheel pilot hole, remove loose particles by wiping with clean rag and apply grease. Apply grease only to the wheel pilot hole surface by smearing a “dime” (1 square cm) sized glob of grease around the wheel pilot surface (1) with end of finger. **DO NOT** apply grease to lug nut/stud holes or wheel-to-brake surfaces.

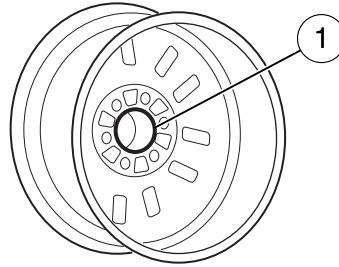

JUMP STARTING

 **WARNING:** The gases around the battery can explode if exposed to flames, sparks, or lit cigarettes. An explosion could result in injury or vehicle damage.

 **WARNING:** Batteries contain sulfuric acid which can burn skin, eyes and clothing, if contacted.

Do not attempt to push-start your automatic transmission vehicle. Automatic transmissions do not have push-start capability. Attempting to push-start a vehicle with an automatic transmission may cause transmission damage.

Preparing your vehicle

When the battery is disconnected or a new battery is installed, the automatic transmission must relearn its shift strategy. As a result, the transmission may have firm and/or soft shifts. This operation is considered normal and will not affect function or durability of the transmission. Over time, the adaptive learning process will fully update transmission operation.

1. **Use only a 12-volt supply to start your vehicle.**
2. Do not disconnect the battery of the disabled vehicle as this could damage the vehicle's electrical system.
3. Park the booster vehicle close to the hood of the disabled vehicle making sure the two vehicles **do not** touch. Set the parking brake on both vehicles and stay clear of the engine cooling fan and other moving parts.

340

Roadside Emergencies

4. Check all battery terminals and remove any excessive corrosion before you attach the battery cables. Ensure that vent caps are tight and level.
5. Turn the heater fan on in both vehicles to protect from any electrical surges. Turn all other accessories off.

Connecting the jumper cables

Note: In the illustration, the vehicle on the bottom is used to designate the assisting (boosting) battery.

1. Connect the positive (+) jumper cable to the positive (+) terminal of the discharged battery.
2. Connect the other end of the positive (+) cable to the positive (+) terminal of the assisting battery.
3. Connect the negative (-) cable to the negative (-) terminal of the assisting battery.
4. Make the final connection of the negative (-) cable to an exposed metal part of the stalled vehicle's engine, away from the battery and the carburetor/fuel injection system.

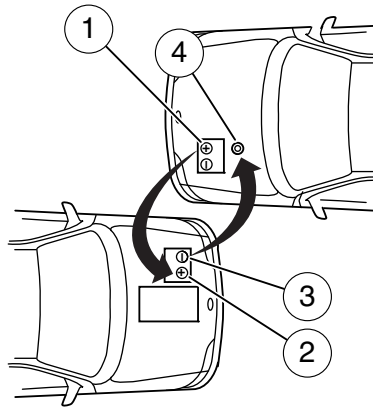

Note: Do not attach the negative (-) cable to fuel lines, engine rocker covers, the intake manifold or electrical components as grounding points.



WARNING: Do not connect the end of the second cable to the negative (-) terminal of the battery to be jumped. A spark may cause an explosion of the gases that surround the battery.

Ensure that the cables are clear of fan blades, belts, moving parts of both engines, or any fuel delivery system parts.

Roadside Emergencies

Jump starting

1. Start the engine of the booster vehicle and run the engine at moderately increased speed.
2. Start the engine of the disabled vehicle.
3. Once the disabled vehicle has been started, run both engines for an additional three minutes before disconnecting the jumper cables.

Removing the jumper cables

Remove the jumper cables in the reverse order that they were connected.

Note: In the illustration, the vehicle on the bottom is used to designate the assisting (boosting) battery.

1. Remove the jumper cable from the ground metal surface.
2. Remove the jumper cable on the negative (-) terminal of the booster vehicle's battery.
3. Remove the jumper cable from the positive (+) terminal of the booster vehicle's battery.
4. Remove the jumper cable from the positive (+) terminal of the disabled vehicle's battery.

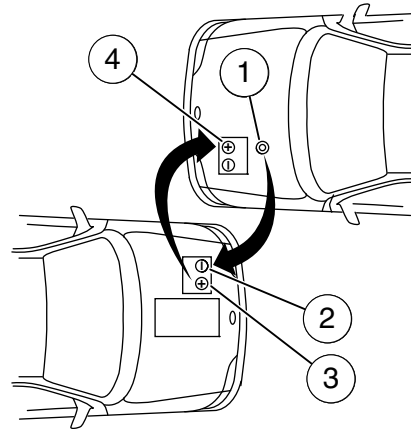

After the disabled vehicle has been started and the jumper cables removed, allow it to idle for several minutes so the engine computer can relearn its idle conditions.

Roadside Emergencies

WRECKER TOWING

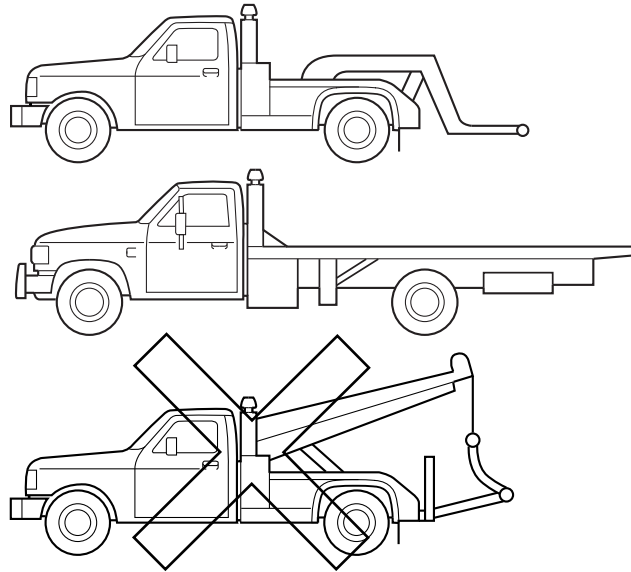

If you need to have your vehicle towed, contact a professional towing service or, if you are a member of a roadside assistance program, your roadside assistance service provider.

It is recommended that the vehicle be towed with a wheel lift or flatbed equipment. Do not tow with a slingshot. Ford Motor Company has not approved a slingshot towing procedure.

On 4x2 vehicles, it is acceptable to tow the vehicle with the front wheels on the ground and the rear wheels off the ground using a wheel lift

On 4x4 vehicles, it is recommended that your vehicle be towed using flatbed equipment with all the wheels off the ground. However, a wheel lift may be used to lift the rear of the vehicle so long as, depending on vehicle configurations, the following preparations are met:

- On Electronic Shift-On-the-Fly (ESOF) vehicles, the 4x4 control is turned to the 2WD position prior to towing.
- On manual-shift transfer case vehicles, the front wheel hub locks are in the FREE position prior to towing.

Roadside Emergencies

Note: Towing an ESOF 4x4 vehicle with the front wheels on the ground without disengaging the front hubs may cause damage to the automatic transmission.

Note: Towing a 4x2 or an ESOF 4x4 vehicle with the rear wheels on the ground for more than 50 miles (80 km) and/or in excess of 35 mph (56 km/h) may cause damage to the automatic transmission.

Note: On Dual Rear Wheel (DRW) vehicles, an outer rear wheel must be removed prior to using a wheel lift wrecker.

Ford Motor Company produces a towing manual for all authorized tow truck operators. Have your tow truck operator refer to this manual for proper hook-up and towing procedures for your vehicle.

If the vehicle is towed by other means or incorrectly, vehicle damage may occur.

Emergency towing

In case of a roadside emergency with a disabled vehicle (without access to wheel dollies, car hauling trailer, or flatbed transport vehicle) your vehicle (regardless of transmission powertrain configuration) can be flat towed (all wheels on the ground) under the following conditions:

- Vehicle is facing forward so that it is being towed in a forward direction.
- Place the transmission in N (Neutral). Refer to *Brake-shift interlock* in the *Driving* chapter for specific instructions if you cannot move the gear shift lever into N (Neutral).
- Maximum speed is not to exceed 35 mph (56 km/h).
- Maximum distance is 50 miles (80 km).

Customer Assistance

GETTING THE SERVICES YOU NEED

Warranty repairs to your vehicle must be performed by an authorized Ford, Lincoln, or Mercury dealer. While any authorized dealer handling your vehicle line will provide warranty service, we recommend you return to your selling authorized dealer who wants to ensure your continued satisfaction.

Please note that certain warranty repairs require special training and/or equipment, so not all authorized dealers are authorized to perform all warranty repairs. This means that, depending on the warranty repair needed, you may have to take your vehicle to another authorized dealer.

A reasonable time must be allowed to perform a repair after taking your vehicle to the authorized dealer. Repairs will be made using Ford or Motorcraft® parts, or remanufactured or other parts that are authorized by Ford.

Away from home

If you are away from home when your vehicle needs service, contact the Ford Customer Relationship Center or use the online resources listed below to find the nearest authorized dealer.

In the United States:

Mailing address

Ford Motor Company
Customer Relationship Center
P.O. Box 6248
Dearborn, MI 48121

Telephone

1-800-392-3673 (FORD)
(TDD for the hearing impaired: 1-800-232-5952)

Online

Additional information and resources are available online at www.genuineservice.com.

- U.S. dealer locator by Dealer Name, City/State, or Zip Code
- Owner Guides
- Maintenance Schedules
- Recalls
- Ford Extended Service Plans
- Ford Genuine Accessories
- Service specials and promotions.

Customer Assistance

In Canada:

Mailing address (Ford vehicles)

Customer Relationship Centre
Ford Motor Company of Canada, Limited
P.O. Box 2000
Oakville, Ontario L6J 5E4

Telephone

1-800-565-3673 (FORD)

Online

www.ford.ca

Mailing address (Lincoln vehicles)

Lincoln Centre
Ford Motor Company of Canada, Limited
P.O. Box 2000
Oakville, Ontario L6J 5E4

Telephone

1-800-387-9333

Online

www.lincolncanada.com

Additional assistance

If you have questions or concerns, or are unsatisfied with the service you are receiving, follow these steps:

1. Contact your Sales Representative or Service Advisor at your selling/servicing authorized dealer.
2. If your inquiry or concern remains unresolved, contact the Sales Manager, Service Manager or Customer Relations Manager.
3. If you require assistance or clarification on Ford Motor Company policies, please contact the Ford Customer Relationship Center

In order to help you serve you better, please have the following information available when contacting a Customer Relationship Center:

- Vehicle Identification Number (VIN)
- Your telephone number (home and business)
- The name of the authorized dealer and city where located
- The vehicle's current odometer reading

In some states, you must directly notify Ford in writing before pursuing remedies under your state's warranty laws. Ford is also allowed a final repair attempt in some states.

346

Customer Assistance

In the United States, a warranty dispute must be submitted to the BBB AUTO LINE before taking action under the Magnuson-Moss Warranty Act, or to the extent allowed by state law, before pursuing replacement or repurchase remedies provided by certain state laws. This dispute handling procedure is not required prior to enforcing state created rights or other rights which are independent of the Magnuson-Moss Warranty Act or state replacement or repurchase laws.

IN CALIFORNIA (U.S. ONLY)

California Civil Code Section 1793.2(d) requires that, if a manufacturer or its representative is unable to repair a motor vehicle to conform to the vehicle's applicable express warranty after a reasonable number of attempts, the manufacturer shall be required to either replace the vehicle with one substantially identical or repurchase the vehicle and reimburse the buyer in an amount equal to the actual price paid or payable by the consumer (less a reasonable allowance for consumer use). The consumer has the right to choose whether to receive a refund or replacement vehicle.

California Civil Code Section 1793.22(b) presumes that the manufacturer has had a reasonable number of attempts to conform the vehicle to its applicable express warranties if, within the first 18 months of ownership of a new vehicle or the first 18,000 miles (29,000 km), whichever occurs first:

1. Two or more repair attempts are made on the same non-conformity likely to cause death or serious bodily injury OR
2. Four or more repair attempts are made on the same nonconformity (a defect or condition that substantially impairs the use, value or safety of the vehicle) OR
3. The vehicle is out of service for repair of nonconformities for a total of more than 30 calendar days (not necessarily all at one time)

In the case of 1 or 2 above, the consumer must also notify the manufacturer of the need for the repair of the nonconformity at the following address:

Ford Motor Company
16800 Executive Plaza Drive
Mail Drop 3NE-B
Dearborn, MI 48126

Customer Assistance

THE BETTER BUSINESS BUREAU (BBB) AUTO LINE PROGRAM (U.S. ONLY)

Your satisfaction is important to Ford Motor Company and to your dealer. If a warranty concern has not been resolved using the three-step procedure outlined on the first page of the *Customer Assistance* section, you may be eligible to participate in the BBB AUTO LINE program.

The BBB AUTO LINE program consists of two parts – mediation and arbitration. During mediation, a representative of the BBB will contact both you and Ford Motor Company to explore options for settlement of the claim. If an agreement is not reached during mediation and your claim is eligible, you may participate in the arbitration process. An arbitration hearing will be scheduled so that you can present your case in an informal setting before an impartial person. The arbitrator will consider the testimony provided and make a decision after the hearing.

You are not bound by the decision, but should you choose to accept the BBB AUTO LINE decision, Ford must abide by the accepted decision as well. Disputes submitted to the BBB AUTO LINE program are usually decided within forty days after you file your claim with the BBB.

BBB AUTO LINE Application: Using the information provided below, please call or write to request a program application. You will be asked for your name and address, general information about your new vehicle, information about your warranty concerns, and any steps you have already taken to try to resolve them. A Customer Claim Form will be mailed that will need to be completed, signed and returned to the BBB along with proof of ownership. Upon receipt, the BBB will review the claim for eligibility under the Program Summary Guidelines.

You can get more information by calling BBB AUTO LINE at 1-800-955-5100, or writing to:

**BBB AUTO LINE
4200 Wilson Boulevard, Suite 800
Arlington, Virginia 22203-1833**

BBB AUTO LINE applications can also be requested by calling the Ford Motor Company Customer Relationship Center at 1-800-392-3673.

Note: Ford Motor Company reserves the right to change eligibility limitations, modify procedures, or to discontinue this process at any time without notice and without obligation.

Customer Assistance

UTILIZING THE MEDIATION/ARBITRATION PROGRAM (CANADA ONLY)

For vehicles delivered to authorized Canadian dealers. In those cases where you continue to feel that the efforts by Ford of Canada and the authorized dealer to resolve a factory-related vehicle service concern have been unsatisfactory, Ford of Canada participates in an impartial third party mediation/arbitration program administered by the Canadian Motor Vehicle Arbitration Plan (CAMVAP).

The CAMVAP program is a straight forward and relatively speedy alternative to resolve a disagreement when all other efforts to produce a settlement have failed. This procedure is without cost to you and is designed to eliminate the need for lengthy and expensive legal proceedings.

In the CAMVAP program, impartial third-party arbitrators conduct hearings at mutually convenient times and places in an informal environment. These impartial arbitrators review the positions of the parties, make decisions and, when appropriate, render awards to resolve disputes. CAMVAP decisions are fast, fair, and final as the arbitrator's award is binding on both you and Ford of Canada.

CAMVAP services are available in all Canadian territories and provinces. For more information, without charge or obligation, call your CAMVAP Provincial Administrator directly at 1-800-207-0685 or visit www.camvap.ca.

GETTING ASSISTANCE OUTSIDE THE U.S. AND CANADA

Before exporting your vehicle to a foreign country, contact the appropriate foreign embassy or consulate. These officials can inform you of local vehicle registration regulations and where to find unleaded fuel.

If you cannot find unleaded fuel or can only get fuel with an anti-knock index lower than is recommended for your vehicle, contact a regional office or owner relations/customer relationship office.

The use of leaded fuel in your vehicle without proper conversion may damage the effectiveness of your emission control system and may cause engine knocking or serious engine damage. Ford Motor Company/Ford of Canada is not responsible for any damage caused by use of improper fuel. Using leaded fuel may also result in difficulty importing your vehicle back into the U.S.

Customer Assistance

If your vehicle must be serviced while you are traveling or living in Asia-Pacific Region, Sub-Saharan Africa, U.S. Virgin Islands, Central America, the Caribbean, and Israel, contact the nearest authorized dealer. If the authorized dealer cannot help you, contact:

FORD MOTOR COMPANY
FORD EXPORT OPERATIONS
1555 Fairlane Drive
Fairlane Business Park #3
Allen Park, Michigan 48101
U.S.A.
Telephone: (313) 594-4857
FAX: (313) 390-0804
Email: expcac@ford.com

If your vehicle must be serviced while you are traveling or living in Puerto Rico, contact the nearest authorized dealer. If the authorized dealer cannot help you, contact:

Ford International Business Development Inc.
Customer Assistance Center
P.O. Box 11957
Caparra Heights Station
San Juan, Puerto Rico 00922-1957
Telephone: (800) 841-FORD (3673)
FAX: (313) 390-0804
Email: prcac@ford.com

If your vehicle must be serviced while you are traveling or living in the Middle East, contact the nearest authorized dealer. If the authorized dealer cannot help you, contact:

Ford Middle East
Customer Relationship Center
P.O. Box 21470
Dubai, United Arab Emirates
Telephone: +971 4 3326084
FAX: +971 4 3327299
Email: menacac@ford.com
www.me.ford.com

If you buy your vehicle in North America and then relocate to any of the above locations, register your vehicle identification number (VIN) and new address with Ford Motor Company Export Operations.

If you are in another foreign country, contact the nearest authorized dealer. If the authorized dealer employees cannot help you, they can direct you to the nearest Ford affiliate office.

Customers in the U.S. should call 1-800-392-3673.

350

Customer Assistance

ORDERING ADDITIONAL OWNER'S LITERATURE

To order the publications in this portfolio, contact Helm, Incorporated at:

HELM, INCORPORATED
P.O. Box 07150
Detroit, Michigan 48207

Or to order a free publication catalog, call toll free: 1-800-782-4356

Monday-Friday 8:00 a.m. - 6:00 p.m. EST

Helm, Incorporated can also be reached by their website: www.helminc.com.

(Items in this catalog may be purchased by credit card, check or money order.)

Obtaining a French Owner's Guide

French Owner's Guides can be obtained from your authorized dealer or by contacting Helm, Incorporated using the contact information listed previously in this section.

REPORTING SAFETY DEFECTS (U.S. ONLY)

If you believe that your vehicle has a defect which could cause a crash or could cause injury or death, you should immediately inform the National Highway Traffic Safety



Administration (NHTSA) in addition to notifying Ford Motor Company.

If NHTSA receives similar complaints, it may open an investigation, and if it finds that a safety defect exists in a group of vehicles, it may order a recall and remedy campaign. However, NHTSA cannot become involved in individual problems between you, your dealer, or Ford Motor Company.

To contact NHTSA, you may call the Vehicle Safety Hotline toll-free at 1-888-327-4236 (TTY: 1-800-424-9153); go to <http://www.safercar.gov>; or write to:

Administrator
1200 New Jersey Avenue, Southeast
Washington, D.C. 20590

You can also obtain other information about motor vehicle safety from <http://www.safercar.gov>.

REPORTING SAFETY DEFECTS (CANADA ONLY)

If you believe that your vehicle has a defect which could cause a crash or could cause injury or death, you should immediately inform Transport Canada, using their toll-free number: 1-800-333-0510.

Cleaning

WASHING THE EXTERIOR

Wash your vehicle regularly with cool or lukewarm water and a neutral pH shampoo, such as Motorcraft® Detail Wash (ZC-3-A), which is available from your authorized dealer.

- Never use strong household detergents or soap, such as dish washing or laundry liquid. These products can discolor and spot painted surfaces.
- Never wash a vehicle that is “hot to the touch” or during exposure to strong, direct sunlight.
- Always use a clean sponge or car wash mitt with plenty of water for best results.
- Dry the vehicle with a chamois or soft terry cloth towel in order to eliminate water spotting.
- It is especially important to wash the vehicle regularly during the winter months, as dirt and road salt are difficult to remove and cause damage to the vehicle.
- Immediately remove items such as gasoline, diesel fuel, bird droppings and insect deposits because they can cause damage to the vehicle’s paintwork and trim over time. Use Motorcraft® Bug and Tar Remover (ZC-42), which is available from your authorized dealer.
- Remove any exterior accessories, such as antennas, before entering a car wash.
- **Suntan lotions and insect repellents can damage any painted surface; if these substances come in contact with your vehicle, wash off as soon as possible.**
- **If your vehicle is equipped with running boards, do not use rubber, plastic and vinyl protectant products on the running board surface, as the area may become slippery.**

Exterior chrome

- Wash the vehicle first, using cool or lukewarm water and a neutral pH shampoo, such as Motorcraft® Detail Wash (ZC-3-A).
- Use Motorcraft® Custom Bright Metal Cleaner (ZC-15), available from your authorized dealer. Apply the product as you would a wax to clean bumpers and other chrome parts; allow the cleaner to dry for a few minutes, then wipe off the haze with a clean, dry rag.
- **Never use abrasive materials such as steel wool or plastic pads as they can scratch the chrome surface.**

352

WAXING

- Wash the vehicle first.
- Use a quality wax that does not contain abrasives.
- Do not allow paint sealant to come in contact with any non-body (low-gloss black) colored trim, such as grained door handles, roof racks, bumpers, side moldings, mirror housings or the windshield cowl area. The paint sealant will “gray” or stain the parts over time.

PAINT CHIPS

Your authorized dealer has touch-up paint to match your vehicle's color. Take your color code (printed on a sticker in the driver's door jamb) to your authorized dealer to ensure you get the correct color.

- Remove particles such as bird droppings, tree sap, insect deposits, tar spots, road salt and industrial fallout before repairing paint chips.
- Always read the instructions before using the products.

ALUMINUM WHEELS AND WHEEL COVERS

Aluminum wheels and wheel covers are coated with a clearcoat paint finish. In order to maintain their shine:

- Clean weekly with Motorcraft® Wheel and Tire Cleaner (ZC-37-A), which is available from your authorized dealer. Heavy dirt and brake dust accumulation may require agitation with a sponge. Rinse thoroughly with a strong stream of water.
- Never apply any cleaning chemical to hot or warm wheel rims or covers.
- Some automatic car washes may cause damage to the finish on your wheel rims or covers. Chemical-strength cleaners, or cleaning chemicals, in combination with brush agitation to remove brake dust and dirt, could wear away the clearcoat finish over time.
- Do not use hydrofluoric acid-based or high caustic-based wheel cleaners, steel wool, fuels or strong household detergent.
- To remove tar and grease, use Motorcraft® Bug and Tar Remover (ZC-42), available from your authorized dealer.

Cleaning

ENGINE

Engines are more efficient when they are clean because grease and dirt buildup keep the engine warmer than normal. When washing:

- Take care when using a power washer to clean the engine. The high-pressure fluid could penetrate the sealed parts and cause damage.
- Do not spray a hot engine with cold water to avoid cracking the engine block or other engine components.
- Spray Motorcraft® Engine Shampoo and Degreaser (ZC-20) on all parts that require cleaning and pressure rinse clean.
- Never wash or rinse the engine while it is hot or running; water in the running engine may cause internal damage.
- Never wash or rinse any ignition coil, spark plug wire or spark plug well, or the area in and around these locations.
- Cover the highlighted areas to prevent water damage when cleaning the engine.

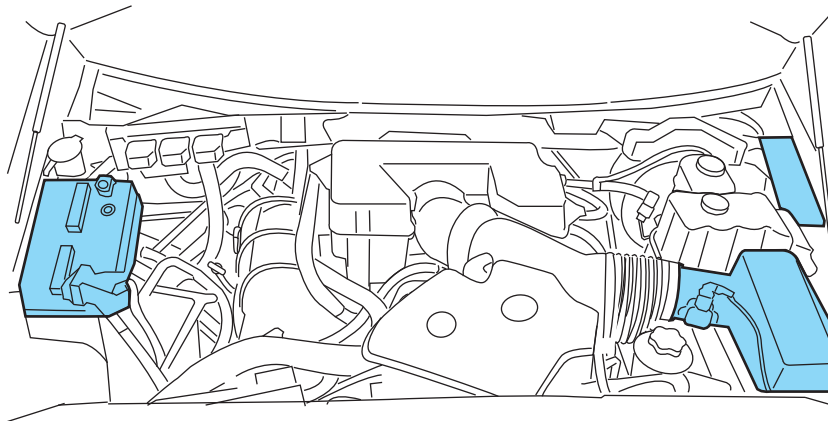

- **6.2L V8 gasoline engine**

Cleaning

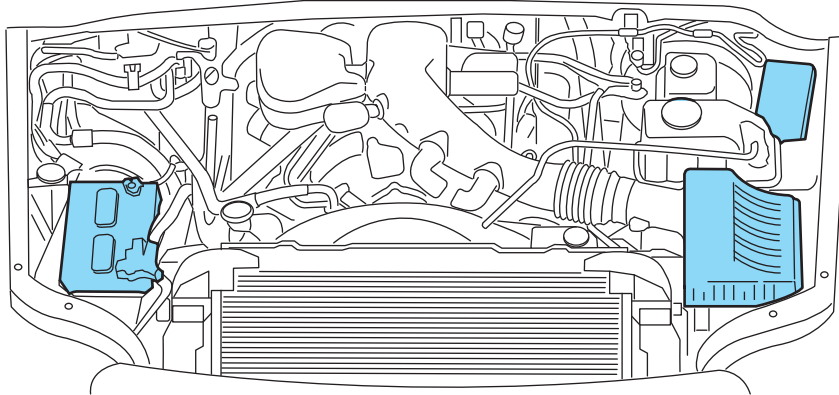

- **6.8L V10 gasoline engine**

PLASTIC (NON-PAINTED) EXTERIOR PARTS

Use only approved products to clean plastic parts. These products are available from your authorized dealer.

- For routine cleaning, use Motorcraft® Detail Wash (ZC-3-A).
- If tar or grease spots are present, use Motorcraft® Bug and Tar Remover (ZC-42).

WINDOWS AND WIPER BLADES

The windshield, rear and side windows and the wiper blades should be cleaned regularly. If the wipers do not wipe properly, substances on the vehicle's glass or the wiper blades may be the cause. These may include hot wax treatments used by commercial car washes, water repellent coatings, tree sap, or other organic contamination; these contaminants may cause squeaking or chatter noise from the blades, and streaking and smearing of the windshield. To clean these items, follow these tips:

- The windshield, rear windows and side windows may be cleaned with a non-abrasive cleaner such as Motorcraft® Ultra-Clear Spray Glass Cleaner (ZC-23), available from your authorized dealer.
- The wiper blades can be cleaned with isopropyl (rubbing) alcohol or Motorcraft® Premium Windshield Washer Concentrate (ZC-32-A) in the U.S., or Premium Quality Windshield Washer Fluid [CXC-37-(A, B, D, or F)] in Canada, available from your authorized dealer. This washer fluid contains special solution in addition to alcohol which

355

Cleaning

helps to remove the hot wax deposited on the wiper blade and windshield from automated car wash facilities. Be sure to replace wiper blades when they appear worn or do not function properly.

- Do not use abrasives, as they may cause scratches.
- Do not use fuel, kerosene, or paint thinner to clean any parts.

INSTRUMENT PANEL/INTERIOR TRIM AND CLUSTER LENS (EXCEPT HARLEY-DAVIDSON)

Clean the instrument panel, interior trim areas and cluster lens with a clean and damp, white cotton cloth, then with a clean and dry, white cotton cloth.

- Avoid cleaners or polishes that increase the gloss of the upper portion of the instrument panel. The dull finish in this area helps protect the driver from undesirable windshield reflection.
- Be certain to wash or wipe your hands clean if you have been in contact with certain products such as insect repellent and suntan lotion in order to avoid possible damage to the interior painted surfaces.
- Do not use household or glass cleaners as these may damage the finish of the instrument panel, interior trim and cluster lens.



WARNING: Do not use chemical solvents or strong detergents when cleaning the steering wheel or instrument panel to avoid contamination of the airbag system.

If a staining liquid like coffee/juice has been spilled on the instrument panel or on interior trim surfaces, clean as follows:

1. Wipe up spilled liquid using a clean white cotton cloth.
2. Wipe the surface with a damp, clean, white cotton cloth. For more thorough cleaning, use a mild soap and water solution. If the spot cannot be completely cleaned by this method, the area may be cleaned using a commercially available cleaning product designed for automotive interiors.
3. If necessary, apply more soap and water solution or cleaning product to a clean, white, cotton cloth and press the cloth onto the soiled area—allow this to set at room temperature for 30 minutes.
4. Remove the soaked cloth, and if it is not soiled badly, use this cloth to clean the area by using a rubbing motion for 60 seconds.
5. Following this, wipe area dry with a clean, white, cotton cloth.

Cleaning

INSTRUMENT PANEL AND CONSOLE (HARLEY-DAVIDSON ONLY)

Your vehicle's instrument panel and console are uniquely painted with both high and low gloss paints that require special care. The high gloss area is similar to that of the vehicle's exterior; the low gloss area is designed to help protect the driver from undesirable windshield reflection.

High gloss paint area

In order to maintain the finish of the instrument panel and console, the high gloss areas should be treated similar to the that of exterior paint or glossy plastic surfaces. When cleaning the high gloss areas:

- **Do not use** paper towels or newspaper.
- **Do not use** silicone or Teflon® (PTFE)-based products.

Dust the high gloss areas with a clean, dry cloth, or use Motorcraft® Dusting Cloth (ZC-24).

For general cleaning, use mild, soapy water and a soft, damp cloth, then dry with a clean, dry cloth.

For removal of fine scuffs and scratches, use Scotch-Brite Microfiber Cloth or cheese cloth along with Motorcraft® Premium Liquid Wax (ZC-53-A). Note: Removal of deep scuffs and scratches should be performed by an authorized dealer or an experienced repair facility.

Low gloss paint area

The low gloss area of the instrument panel's upper dash should be cleaned with mild, soapy water and a soft, damp cloth, then dried with a clean, dry cloth. When cleaning the low gloss areas:

- **Do not use** paper towels or newspaper.
- **Do not use** silicone or Teflon® (PTFE)-based products.
- **Do not use** exterior paint waxes or sealants.

Dust the low gloss areas with a clean, dry cloth, or use Motorcraft® Dusting Cloth (ZC-24).

INTERIOR

For fabric, carpets, cloth seats and safety belts:

- Remove dust and loose dirt with a vacuum cleaner.
- Remove light stains and soil with Motorcraft® Professional Strength Carpet & Upholstery Cleaner (ZC-54).
- If grease or tar is present on the material, spot-clean the area first with Motorcraft® Spot and Stain Remover (ZC-14). In Canada, use Motorcraft® Multi-Purpose Cleaner (CXC-101).

Cleaning

- If a ring forms on the fabric after spot cleaning, clean the entire area immediately (but do not oversaturate) or the ring will set.
- Do not use household cleaning products or glass cleaners, which can stain and discolor the fabric and affect the flame retardant abilities of the seat materials.



WARNING: Do not use cleaning solvents, bleach or dye on the vehicle's seatbelts, as these actions may weaken the belt webbing.

LEATHER SEATS (IF EQUIPPED, EXCEPT FOR THE KING RANCH® EDITION)

For King Ranch® leather seats, refer to a separate section in this chapter.

- Clean spills and stains as quickly as possible.
- For routine cleaning, wipe the surface with a soft, damp cloth. For more thorough cleaning, wipe the surface with a mild soap and water solution. In Canada, use Motorcraft® Vinyl Cleaner (CXC-93). Dry the area with a soft cloth.
- If the leather cannot be completely cleaned using a mild soap and water solution, the leather may be cleaned using a commercially available leather cleaning product designed for automotive interiors.
- To check for compatibility, first test any cleaner or stain remover on an inconspicuous part of the leather.
- Do not use household cleaning products, alcohol solutions, solvents or cleaners intended for rubber, vinyl and plastics, or oil/petroleum-based leather conditioners. These products may cause premature wearing or damage to the leather.

LEATHER SEATS FOR THE KING RANCH® EDITION ONLY (IF EQUIPPED)

Your vehicle is equipped with seating covered in premium, top-grain leather which is extremely durable, but still requires special care and maintenance in order to ensure longevity and comfort.

Regular cleaning and conditioning will maintain the appearance of the leather.

Cleaning

For dirt, use a vacuum cleaner then use a clean, damp cloth or soft brush.

358

Cleaning

For routine cleaning, wipe the surface with a soft, damp cloth. For more thorough cleaning, wipe the surface with a mild soap and water solution.

- Clean spills as quickly as possible.
- Test any cleaner or stain remover on an inconspicuous part of the leather as cleaners may darken the leather.
- Do not spill coffee, ketchup, mustard, orange juice or oil-based products on the leather as they may permanently stain the leather.
- Do not use household cleaning products, alcohol solutions, solvents or cleaners intended for rubber, vinyl or plastics.

Scratches

Natural Markings - Because the leather in the seat comes from genuine steer hides, there will be evidence of naturally occurring markings, such as small scars. These markings give character to the seating covers and should be considered as proof of a genuine leather product.

In order to lessen the appearance of certain scratches and other wear marks, apply conditioner on the affected area following the same instructions as in the *Conditioning* section.

Conditioning

Bottles of King Ranch® Leather Conditioner are available at the King Ranch® Saddle Shop. Visit the website at www.krsaddleshop.com, or telephone (in the United States) 1-800-282-KING (5464). If you are unable to obtain King Ranch® Leather Conditioner, use another premium leather conditioner.

- Clean the surfaces using the steps outlined in the *Cleaning* section.
- Ensure the leather is dry then apply a nickel-sized amount of conditioner to a clean, dry cloth.
- Rub the conditioner into leather until it disappears. Allow the conditioner to dry and repeat the process for the entire interior. If a film appears, wipe off film with a dry, clean cloth.

UNDERBODY

Flush the complete underside of your vehicle frequently. Keep body and door drain holes free from packed dirt.

Note: Use care when using a power washer to clean the driveline, especially the driveshaft and interfacing components. The high-pressure fluid could penetrate the sealed parts and cause damage.

Cleaning

FORD, LINCOLN AND MERCURY CAR CARE PRODUCTS

Your authorized dealer has many quality products available to clean your vehicle and protect its finishes. These quality products have been specifically engineered to fulfill your automotive needs; they are custom designed to complement the style and appearance of your vehicle. Each product is made from high quality materials that meet or exceed rigid specifications. For best results, use the following products or products of equivalent quality:

- Motorcraft® Bug and Tar Remover (ZC-42)
- Motorcraft® Custom Bright Metal Cleaner (ZC-15)
- Motorcraft® Detail Wash (ZC-3-A)
- Motorcraft® Dusting Cloth (ZC-24)
- Motorcraft® Engine Shampoo and Degreaser (U.S. only) (ZC-20)
- Motorcraft® Engine Shampoo (Canada only) (CXC-66-A)
- Motorcraft® Multi-Purpose Cleaner (Canada only) (CXC-101)
- Motorcraft® Premium Glass Cleaner (Canada only) (CXC-100)
- Motorcraft® Professional Strength Carpet & Upholstery Cleaner (ZC-54)
- Motorcraft® Spot and Stain Remover (U.S. only) (ZC-14)
- Motorcraft® Ultra-Clear Spray Glass Cleaner (ZC-23)
- Motorcraft® Vinyl Cleaner (Canada only) (CXC-93)
- Motorcraft® Wheel and Tire Cleaner (ZC-37-A)

Maintenance and Specifications

SERVICE RECOMMENDATIONS

To help you service your vehicle, we provide *scheduled maintenance information* which makes tracking routine service easy.

If your vehicle requires professional service, your authorized dealer can provide the necessary parts and service. Check your *Warranty Guide* to find out which parts and services are covered.

Use only recommended fuels, lubricants, fluids and service parts conforming to specifications. Motorcraft® parts are designed and built to provide the best performance in your vehicle.

PRECAUTIONS WHEN SERVICING YOUR VEHICLE

- Do not work on a hot engine.
- Make sure that nothing gets caught in moving parts.
- Do not work on a vehicle with the engine running in an enclosed space, unless you are sure you have enough ventilation.
- Keep all open flames and other burning material (such as cigarettes) away from the battery and all fuel related parts.

Working with the engine off

1. Set the parking brake and ensure the gearshift is securely latched in P (Park).
2. Turn off the engine and remove the key.
3. Block the wheels to prevent the vehicle from moving unexpectedly.

Working with the engine on

1. Set the parking brake and shift to P (Park).
2. Block the wheels.



WARNING: To reduce the risk of vehicle damage and/or personal burn injuries, do not start your engine with the air cleaner removed and do not remove it while the engine is running.

Maintenance and Specifications

OPENING THE HOOD

1. Inside the vehicle, pull the hood release handle located under the bottom left corner of the instrument panel.
2. Go to the front of the vehicle to release the auxiliary latch located at the top center of the grille. Slide the handle left to release the auxiliary latch.
3. Lift the hood until the lift cylinders hold it open.

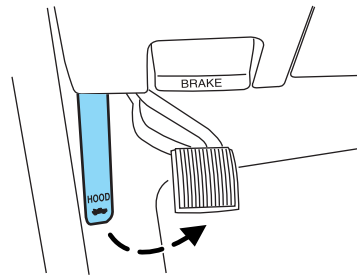

IDENTIFYING COMPONENTS IN THE ENGINE COMPARTMENT

Refer to the diesel supplement for diesel engine component locations.

Maintenance and Specifications

6.2L V8 gasoline engine

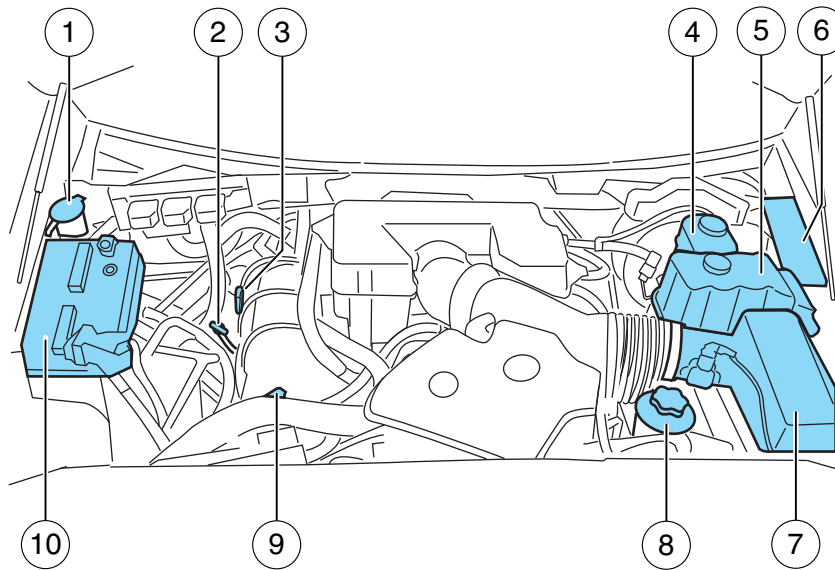

1. Windshield washer fluid reservoir
2. Engine oil dipstick
3. Automatic transmission fluid dipstick
4. Brake fluid reservoir
5. Engine coolant reservoir
6. Power distribution box (not shown)
7. Air filter assembly
8. Power steering fluid reservoir
9. Engine oil filler cap
10. Battery

Maintenance and Specifications

6.8L V10 gasoline engine

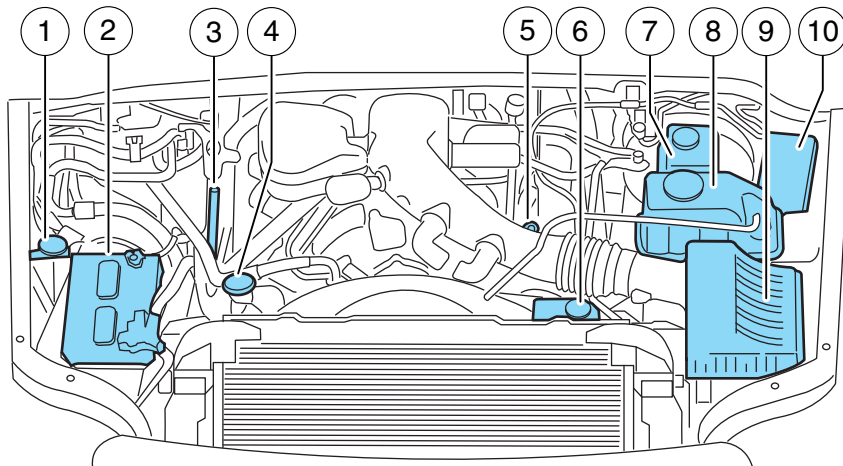

1. Windshield washer fluid reservoir
2. Battery
3. Automatic transmission fluid dipstick
4. Engine oil filler cap
5. Engine oil dipstick
6. Power steering fluid reservoir
7. Brake fluid reservoir
8. Engine coolant reservoir
9. Air filter assembly
10. Power distribution box

Maintenance and Specifications

WINDSHIELD WASHER FLUID

Add fluid to fill the reservoir if the level is low. In very cold weather, do not fill the reservoir completely.

Only use a washer fluid that meets Ford specifications. Do not use any special washer fluid such as windshield water repellent type fluid or bug wash. They may cause squeaking, chatter noise, streaking and smearing. Refer to *Maintenance product specifications and capacities* in this chapter.



State or local regulations on volatile organic compounds may restrict the use of methanol, a common windshield washer antifreeze additive. Washer fluids containing non-methanol antifreeze agents should be used only if they provide cold weather protection without damaging the vehicle's paint finish, wiper blades or washer system.



WARNING: If you operate your vehicle in temperatures below 40°F (5°C), use washer fluid with antifreeze protection. Failure to use washer fluid with antifreeze protection in cold weather could result in impaired windshield vision and increase the risk of injury or accident.

CHANGING THE WIPER BLADES

1. Pull the wiper arm away from the vehicle. Pry open the lock cover with your thumb (1) to release the blade and pull the wiper blade down toward the windshield to remove it from the arm (2).

2. Insert the wiper arm hook into the wiper arm (3).

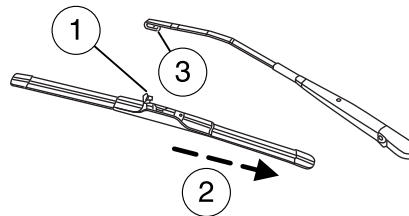

Replace wiper blades at least once per year for optimum performance.

Poor wiper quality can be improved by cleaning the wiper blades and the windshield. Refer to *Windows and wiper blades* in the *Cleaning* chapter.

Maintenance and Specifications

To prolong the life of the wiper blades, it is highly recommended to scrape off the ice on the windshield before turning on the wipers. The layer of ice has many sharp edges and can damage the micro edge of the wiper rubber element.

ENGINE OIL

Checking the engine oil

Refer to the *scheduled maintenance information* for the appropriate intervals for checking the engine oil.

1. Make sure the vehicle is on level ground.
2. Turn the engine off and wait 15 minutes for the oil to drain into the oil pan.
3. Set the parking brake and ensure the gearshift is securely latched in P (Park).
4. Open the hood. Protect yourself from engine heat.
5. Locate and carefully remove the engine oil dipstick.
 - 6.2L/6.8L gasoline engines only; for diesel engine information, refer to the diesel supplement.

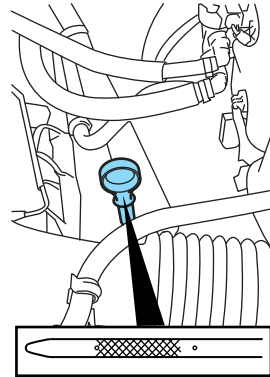

6. Wipe the dipstick clean. Insert the dipstick fully, then remove it again.
 - If the oil level is **between the two holes**, the oil level is acceptable. **DO NOT ADD OIL.**
 - If the oil level is at or below the lower hole, add enough oil to raise the level to within the two holes.
 - Oil levels above the upper hole may cause engine damage. Some oil must be removed from the engine by a service technician.
7. Put the dipstick back in and ensure it is fully seated.

366

Maintenance and Specifications

Adding engine oil

1. Check the engine oil. For instructions, refer to *Checking the engine oil* in this chapter.
2. If the engine oil level is not within the normal range, add only certified engine oil of the recommended viscosity. Remove the engine oil filler cap and use a funnel to pour the engine oil into the opening.
3. Recheck the engine oil level. Make sure the oil level is not above the normal operating range on the engine oil level dipstick.
4. Install the dipstick and ensure it is fully seated.
5. Fully install the engine oil filler cap by turning the filler cap clockwise 1/4 of a turn until three clicks are heard or until the cap is fully seated.

To avoid possible oil loss, DO NOT operate the vehicle with the engine oil level dipstick and/or the engine oil filler cap removed.

Engine oil and filter recommendations

Look for this certification trademark.

(6.2L/6.8L gasoline engines only. For diesel engine information, refer to the diesel supplement).

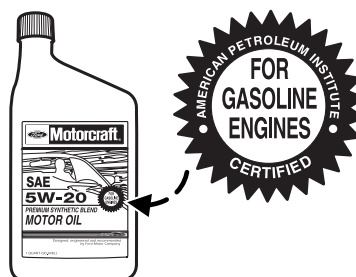

Use SAE 5W-20 engine oil

Only use oils certified for gasoline engines by the American Petroleum Institute (API). An oil with this trademark symbol conforms to the current engine and emission system protection standards and fuel economy requirements of the International Lubricant Standardization and Approval Committee (ILSAC), comprised of U.S. and Japanese automobile manufacturers.

To protect your engine and engine's warranty, use Motorcraft® SAE 5W-20 or an equivalent SAE 5W-20 oil meeting Ford specification WSS-M2C930-A. **SAE 5W-20 oil provides optimum fuel economy and durability performance meeting all requirements for your vehicle's engine.** Refer to *Maintenance product specifications and capacities* later in this chapter for more information.

Maintenance and Specifications

Do not use supplemental engine oil additives, cleaners or other engine treatments. They are unnecessary and could lead to engine damage that is not covered by Ford warranty.

Change your engine oil and filter according to the appropriate schedule listed in the *scheduled maintenance information*.

Ford production and Motorcraft® replacement oil filters are designed for added engine protection and long life. If a replacement oil filter is used that does not meet Ford material and design specifications, start-up engine noises or knock may be experienced.

It is recommended you use the appropriate Motorcraft® oil filter or another with equivalent performance for your engine application.

BATTERY



WARNING: This vehicle may be equipped with more than one battery, removal of cable from only one battery does not disconnect the vehicle electrical system. Be sure to disconnect cables from all batteries when disconnecting power. Failure to do so may cause serious personal injury or property damage.

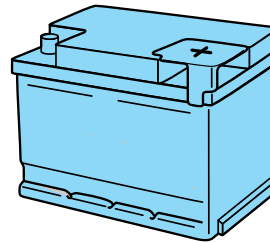

Your vehicle is equipped with a Motorcraft® maintenance-free battery which normally does not require additional water during its life of service.

If your battery has a cover/shield, make sure it is reinstalled after the battery has been cleaned or replaced.

For longer, trouble-free operation, keep the top of the battery clean and dry. Also, make certain the battery cables are always tightly fastened to the battery terminals.

If you see any corrosion on the battery or terminals, remove the cables from the terminals and clean with a wire brush. You can neutralize the acid with a solution of baking soda and water.

It is recommended that the negative battery cable terminal be disconnected from the battery if you plan to store your vehicle for an extended period of time. This will minimize the discharge of your battery during storage.

368

Maintenance and Specifications

Note: Electrical or electronic accessories or components added to the vehicle by the dealer or the owner may adversely affect battery performance and durability.



WARNING: Batteries normally produce explosive gases which can cause personal injury. Therefore, do not allow flames, sparks or lighted substances to come near the battery. When working near the battery, always shield your face and protect your eyes. Always provide proper ventilation.



WARNING: When lifting a plastic-cased battery, excessive pressure on the end walls could cause acid to flow through the vent caps, resulting in personal injury and/or damage to the vehicle or battery. Lift the battery with a battery carrier or with your hands on opposite corners.



WARNING: Keep batteries out of reach of children. Batteries contain sulfuric acid. Avoid contact with skin, eyes or clothing. Shield your eyes when working near the battery to protect against possible splashing of acid solution. In case of acid contact with skin or eyes, flush immediately with water for a minimum of 15 minutes and get prompt medical attention. If acid is swallowed, call a physician immediately.



WARNING: Battery posts, terminals and related accessories contain lead and lead compounds. **Wash hands after handling.**

Because your vehicle's engine is electronically controlled by a computer, some control conditions are maintained by power from the battery. When the battery is disconnected or a new battery is installed, the engine must relearn its idle and fuel trim strategy for optimum driveability and performance. To begin this process:

1. With the vehicle at a complete stop, set the parking brake.
2. Put the gearshift in P (Park), turn off all accessories and start the engine.
3. Run the engine until it reaches normal operating temperature.
4. Allow the engine to idle for at least one minute.
5. Turn the A/C on and allow the engine to idle for at least one minute.

369

Maintenance and Specifications

6. Release the parking brake. With your foot on the brake pedal and with the A/C on, put the vehicle in D (Drive) and allow the engine to idle for at least one minute.

7. Drive the vehicle to complete the relearning process.

- The vehicle may need to be driven 10 miles (16 km) or more to relearn the idle and fuel trim strategy.
- **If you do not allow the engine to relearn its idle trim, the idle quality of your vehicle may be adversely affected until the idle trim is eventually relearned.**

If the battery has been disconnected or a new battery has been installed, the clock and radio settings must be reset once the battery is reconnected.

- Always dispose of automotive batteries in a responsible manner. Follow your local authorized standards for disposal. Call your local authorized recycling center to find out more about recycling automotive batteries.

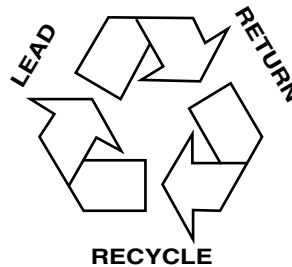

ENGINE COOLANT

Checking engine coolant

The concentration and level of engine coolant should be checked at the intervals listed in *scheduled maintenance information*. The coolant concentration should be maintained at 50/50 coolant and distilled water, which equates to a freeze point of -34°F (-36°C). Coolant concentration testing is possible with a hydrometer or antifreeze tester. The level of coolant should be maintained at the FULL COLD level or within the COLD FILL RANGE in the coolant reservoir. If the level falls below, add coolant per the instructions in the *Adding engine coolant* section.

Your vehicle was factory-filled with a 50/50 engine coolant and water concentration. If the concentration of coolant falls below 40% or above 60%, the engine parts could become damaged or not work properly. **A 50/50 mixture of coolant and water provides the following:**

- **Freeze protection down to -34°F (-36°C).**
- **Boiling protection up to 265°F (129°C).**

370

Maintenance and Specifications

- **Protection against rust and other forms of corrosion.**
- **Proper function of calibrated gauges.**

When the engine is cold, check the level of the engine coolant in the reservoir.



- The engine coolant should be at the FULL COLD level, or within the COLD FILL or MIN / MAX range as listed on the engine coolant reservoir (depending upon application).
- Refer to *scheduled maintenance information* for service interval schedules.

If the engine coolant has not been checked at the recommended interval, the engine coolant reservoir may become low or empty. If the reservoir is low or empty, add engine coolant to the reservoir. Refer to *Adding engine coolant* in this chapter.

Note: Automotive fluids are not interchangeable; do not use engine coolant/antifreeze or windshield washer fluid outside of its specified function and vehicle location.

Adding engine coolant

When adding coolant, make sure it is a 50/50 mixture of engine coolant and distilled water. Add the mixture to the coolant reservoir, **when the engine is cool**, until the appropriate fill level is obtained. If coolant is filled to the COLD FILL RANGE or FULL COLD level when the engine is not cool, the system will remain underfilled.



WARNING: Do not add engine coolant when the engine is hot. Steam and scalding liquids released from a hot cooling system can burn you badly. Also, you can be burned if you spill coolant on hot engine parts.

Maintenance and Specifications



WARNING: Do not put engine coolant in the windshield washer fluid container. If sprayed on the windshield, engine coolant could make it difficult to see through the windshield.

- **DO NOT MIX** different colors or types of coolant in your vehicle. Make sure the correct coolant is used. **DO NOT MIX** recycled coolant and new (unused) coolant together in the vehicle. Mixing of engine coolants may harm your engine's cooling system. The use of an improper coolant may harm engine and cooling system components and may void the warranty. Refer to *Maintenance product specifications and capacities* in this chapter.

Note: Do not use stop leak pellets or cooling system sealants/additives as they can cause damage to the engine cooling and/or heating systems. This damage would not be covered under your vehicle's warranty.

- A large amount of water without engine coolant may be added, in case of emergency, to reach a vehicle service location. In this instance, the cooling system must be drained and refilled with a 50/50 mixture of engine coolant and distilled water as soon as possible. Water alone (without engine coolant) can cause engine damage from corrosion, overheating or freezing.
- **Do not use alcohol, methanol, brine or any engine coolants mixed with alcohol or methanol antifreeze (coolant).** Alcohol and other liquids can cause engine damage from overheating or freezing.
- **Do not add extra inhibitors or additives to the coolant.** These can be harmful and compromise the corrosion protection of the engine coolant.

For vehicles with overflow coolant systems with a non-pressurized cap on the coolant recovery system, add coolant to the coolant recovery reservoir when the engine is cool. Add the proper mixture of coolant and distilled water to the FULL COLD level. For all other vehicles which have a coolant degas system with a pressurized cap, or if it is necessary to remove the coolant pressure relief cap on the radiator of a vehicle with an overflow system, follow these steps to add engine coolant.



WARNING: To reduce the risk of personal injury, make sure the engine is cool before unscrewing the coolant pressure relief cap. The cooling system is under pressure; steam and hot liquid can come out forcefully when the cap is loosened slightly.

Maintenance and Specifications

Add the proper mixture of coolant and water to the cooling system by following these steps:

1. Before you begin, turn the engine off and let it cool.
2. When the engine is cool, wrap a thick cloth around the coolant pressure relief cap on the coolant reservoir (a translucent plastic bottle). Slowly turn cap counterclockwise (left) until pressure begins to release.
3. Step back while the pressure releases.
4. When you are sure that all the pressure has been released, use the cloth to turn it counterclockwise and remove the cap.
5. Fill the coolant reservoir slowly with the proper coolant mixture, to within the COLD FILL RANGE or the FULL COLD level on the reservoir. If you removed the radiator cap in an overflow system, fill the radiator until the coolant is visible and radiator is almost full.
6. Replace the cap. Turn until tightly installed. Cap must be tightly installed to prevent coolant loss.

After any coolant has been added, check the coolant concentration (refer to *Checking engine coolant*). If the concentration is not 50/50 (protection to $-34^{\circ}\text{F}/-36^{\circ}\text{C}$), drain some coolant and adjust the concentration. It may take several drains and additions to obtain a 50/50 coolant concentration.

Whenever coolant has been added, the coolant level in the coolant reservoir should be checked the next few times you drive the vehicle. If necessary, add enough 50/50 concentration of engine coolant and distilled water to bring the liquid level to the proper level.

If you have to add more than 1.0 quart (1.0 liter) of engine coolant per month, have your authorized dealer check the engine cooling system. Your cooling system may have a leak. Operating an engine with a low level of coolant can result in engine overheating and possible engine damage.

Recycled engine coolant

Ford Motor Company does NOT recommend the use of recycled engine coolant since a Ford-approved recycling process is not yet available.



Used engine coolant should be disposed of in an appropriate manner. Follow your community's regulations and standards for recycling and disposing of automotive fluids.

Maintenance and Specifications

Coolant refill capacity

To find out how much fluid your vehicle's cooling system can hold, refer to *Maintenance product specifications and capacities* in this chapter.

If your vehicle is equipped with a diesel engine, refer to the *Maintenance product specifications and capacities* section of your diesel supplement.

Fill your engine coolant reservoir as outlined in *Adding engine coolant* in this section.

Severe climates

If you drive in extremely cold climates (less than -34°F [-36°C]):

- **It may be necessary to increase the coolant concentration above 50%.**
- **NEVER increase the coolant concentration above 60%. Increased engine coolant concentrations above 60% will decrease the overheat protection characteristics of the engine coolant and may cause engine damage.**
- **If available, refer to the chart on the coolant container to ensure the coolant concentration in your vehicle will provide adequate freeze protection at the temperatures in which you drive in the winter months.**

If you drive in extremely hot climates:

- **It is still necessary to maintain the coolant concentration above 40%.**
- **NEVER decrease the coolant concentration below 40%. Decreased engine coolant concentrations below 40% will decrease the corrosion/freeze protection characteristics of the engine coolant and may cause engine damage.**
- **If available, refer to the chart on the coolant container to ensure the coolant concentration in your vehicle will provide adequate protection at the temperatures in which you drive.**

Vehicles driven year-round in non-extreme climates should use a 50/50 mixture of engine coolant and distilled water for optimum cooling system and engine protection.

What you should know about fail-safe cooling (if equipped)

If the engine coolant supply is depleted, this feature allows the vehicle to be driven temporarily before incremental component damage is incurred. The "fail-safe" distance depends on ambient temperatures, vehicle load and terrain.

374

Maintenance and Specifications

How fail-safe cooling works

If the engine begins to overheat:

- The engine coolant temperature gauge will move to the red (hot) area.
- The message center will indicate the engine is overheating.
- The service engine soon  indicator will illuminate.

If the engine reaches a preset over-temperature condition, the engine will automatically switch to alternating cylinder operation. Each disabled cylinder acts as an air pump and cools the engine.

When this occurs the vehicle will still operate. However:

- The engine power will be limited.
- The air conditioning system will be disabled.

Continued operation will increase the engine temperature and the engine will completely shut down, causing steering and braking effort to increase.

Once the engine temperature cools, the engine can be re-started. Take your vehicle to a service facility as soon as possible to minimize engine damage.

When fail-safe mode is activated

You have limited engine power when in the fail-safe mode, so drive the vehicle with caution. The vehicle will not be able to maintain high-speed operation and the engine will run rough. Remember that the engine is capable of completely shutting down automatically to prevent engine damage; therefore:

1. Pull off the road as soon as safely possible and turn off the engine.
2. Arrange for the vehicle to be taken to a service facility.
3. If this is not possible, wait a short period for the engine to cool.
4. Check the coolant level and replenish if low.



WARNING: Never remove the coolant reservoir cap while the engine is running or hot.

5. Re-start the engine and take your vehicle to a service facility.

Driving the vehicle without repairing the engine problem increases the chance of engine damage. Take your vehicle to a service facility as soon as possible.

Maintenance and Specifications

Engine fluid temperature management (except 6.8L V10)

Your vehicle has been designed to pull a trailer, but because of the added load, the vehicle's engine may temporarily reach higher temperatures during severe operating conditions such as ascending a long or steep grade while pulling a trailer in hot ambient temperatures.

At this time, you may notice your engine coolant temperature gauge needle move toward the H and the POWER REDUCED TO LOWER TEMP message may appear on the message center.

You may notice a reduction in the vehicle's speed caused by reduced engine power. Your vehicle has been designed to enter this mode if certain high temperature/high load conditions take place in order to manage the engine's fluid temperatures. The amount of speed reduction will depend on the vehicle loading, towing, grade, ambient temperature, and other factors. If this occurs, there is no need to pull off the road. The vehicle can continue to be driven while this message is active.



WARNING: To reduce the risk of collision and injury, be prepared that the vehicle speed may reduce and the vehicle may not be able to accelerate with full power until the fluid temperatures reduce.

The air conditioning may also cycle on and off during severe operating conditions to protect overheating of the engine. When the engine coolant temperature decreases to a more normal operating temperature, the air conditioning will turn on once again.

If you notice any of the following:

- the engine coolant temperature gauge moves fully into the red (hot) area
 - the coolant temperature warning light illuminates
 - the service engine soon indicator illuminates
1. Pull off the road as soon as safely possible and place the vehicle in P (Park).
 2. Leave the engine running until the coolant temperature gauge needle moves away from the H range. After several minutes, if this does not happen, follow the remaining steps.
 3. Turn the engine off and wait for it to cool before checking the coolant level.

376

Maintenance and Specifications



WARNING: Never remove the coolant reservoir cap while the engine is running or hot.

4. If the coolant level is normal, you may restart your engine and continue on.
5. If the coolant is low, add coolant, restart the engine and take your vehicle to an authorized dealer. See *Adding engine coolant* in this chapter for more information.

Refer to fail-safe cooling for additional information.

FUEL FILTER

Your vehicle is equipped with a lifetime fuel filter that is integrated with the fuel tank. Regular maintenance or replacement is not needed.

WHAT YOU SHOULD KNOW ABOUT AUTOMOTIVE FUELS

Important safety precautions



WARNING: Do not overfill the fuel tank. The pressure in an overfilled tank may cause leakage and lead to fuel spray and fire.



WARNING: The fuel system may be under pressure. If the fuel filler cap is venting vapor or if you hear a hissing sound, wait until it stops before completely removing the fuel filler cap. Otherwise, fuel may spray out and injure you or others.



WARNING: If you do not use the proper fuel filler cap, excessive vacuum in the fuel tank may damage the fuel system or cause the fuel cap to disengage in a collision, which may result in serious personal injury.



WARNING: Automotive fuels can cause serious injury or death if misused or mishandled.



WARNING: Fuel ethanol and gasoline may contain benzene, which is a cancer-causing agent.

Maintenance and Specifications

Observe the following guidelines when handling automotive fuel:

- Extinguish all smoking materials and any open flames before fueling your vehicle.
- Always turn off the vehicle before fueling.
- Automotive fuels can be harmful or fatal if swallowed. Fuels such as gasoline and ethanol are highly toxic and if swallowed can cause death or permanent injury. If fuel is swallowed, call a physician immediately, even if no symptoms are immediately apparent. The toxic effects of fuel may not be visible for hours.
- Avoid inhaling fuel vapors. Inhaling too much fuel vapor of any kind can lead to eye and respiratory tract irritation. In severe cases, excessive or prolonged breathing of fuel vapor can cause serious illness and permanent injury.
- Avoid getting fuel liquid in your eyes. If fuel is splashed in the eyes, remove contact lenses (if worn), flush with water for 15 minutes and seek medical attention. Failure to seek proper medical attention could lead to permanent injury.
- Fuels can also be harmful if absorbed through the skin. If fuel is splashed on the skin and/or clothing, promptly remove contaminated clothing and wash skin thoroughly with soap and water. Repeated or prolonged skin contact with fuel liquid or vapor causes skin irritation.
- Be particularly careful if you are taking “Antabuse” or other forms of disulfiram for the treatment of alcoholism. Breathing gasoline and/or ethanol vapors, or skin contact could cause an adverse reaction. In sensitive individuals, serious personal injury or sickness may result. If fuel is splashed on the skin, promptly wash skin thoroughly with soap and water. Consult a physician immediately if you experience an adverse reaction.
- FFV fuel tanks may contain zero to 85% ethanol. Any fuel blends containing gasoline and ethanol should be treated the same as “Fuel Ethanol.” To identify if your vehicle is an FFV, it may be equipped with a yellow fuel cap with the text “E85/Gasoline”, or check if there is a label on the fuel filler door.



Maintenance and Specifications

Pure ethanol is the alcohol which is the intoxicating agent in liquor, beer and wine. It is distilled from the fermentation of plants such as field corn and sugar cane. When ethanol is produced for use in motor fuels, a small amount of gasoline is added to make it unfit for beverage use. The resulting ethanol blend is called denatured fuel ethanol meaning that it is denatured with 2% to 5% gasoline and is suitable for automotive use.

During the summer season, fuel ethanol may contain a maximum of 85% denatured ethanol (Ed85) and 15% unleaded gasoline. The fuel ethanol has a higher octane rating than unleaded regular or premium gasoline and this allows the design of engines with greater efficiency and power.

Winter blends may contain up to 75% denatured ethanol (Ed75) and up to 25% unleaded gasoline to enhance cold engine starts. Severely cold weather may require additional measures for reliable starting. Refer to *Starting* in the *Driving* chapter.

Ethanol is more chemically active than gasoline. It corrodes some metals and causes some plastic and rubber components to swell, break down or become brittle and crack, especially when mixed with gasoline. Special materials and procedures have been developed for flexible fuel vehicles and the dispensers used by ethanol fuel providers.



WARNING: Flexible fuel components and standard unleaded gasoline fuel components are not interchangeable. If your vehicle is not serviced in accordance with flexible fuel vehicles procedures, damage may occur and your warranty may be invalidated.



WARNING: When refueling always shut the engine off and never allow sparks or open flames near the filler neck. Never smoke while refueling. Fuel vapor is extremely hazardous under certain conditions. Care should be taken to avoid inhaling excess fumes.



WARNING: The flow of fuel through a fuel pump nozzle can produce static electricity, which can cause a fire if fuel is pumped into an ungrounded fuel container.

Maintenance and Specifications

Refueling



WARNING: Fuel vapor burns violently and a fuel fire can cause severe injuries. To help avoid injuries to you and others:

- Read and follow all the instructions on the pump island;
- Turn off your engine when you are refueling;
- Do not smoke if you are near fuel or refueling your vehicle;
- Keep sparks, flames and smoking materials away from fuel;
- Stay outside your vehicle and do not leave the fuel pump unattended when refueling your vehicle — this is against the law in some places;
- Keep children away from the fuel pump; never let children pump fuel.
- Do not use personal electronic devices while refueling.

Use the following guidelines to avoid electrostatic charge build-up when filling an ungrounded fuel container:

- Place approved fuel container on the ground.
- DO NOT fill a fuel container while it is in the vehicle (including the cargo area).
- Keep the fuel pump nozzle in contact with the fuel container while filling.
- DO NOT use a device that would hold the fuel pump handle in the fill position.

Fuel filler cap

When fueling your vehicle:

1. Turn the engine off.
2. Carefully turn the filler cap counterclockwise until it spins off.
3. Pull to remove the cap from the fuel filler pipe.
4. To install the cap, align the tabs on the cap with the notches on the filler pipe.
5. Turn the filler cap clockwise until it clicks.

If the check fuel cap indicator comes on and stays on after you start the engine, the fuel filler cap may not be properly installed. Turn off the engine, remove the fuel filler cap, align the cap properly and reinstall it.

If you must replace the fuel filler cap, replace it with a fuel filler cap that is designed for your vehicle. The vehicle warranty may be void for any damage to the fuel tank or fuel system if the correct genuine Ford or Motorcraft® fuel filler cap is not used.

380

Maintenance and Specifications

 **WARNING:** The fuel system may be under pressure. If the fuel filler cap is venting vapor or if you hear a hissing sound, wait until it stops before completely removing the fuel filler cap. Otherwise, fuel may spray out and injure you or others.

 **WARNING:** If you do not use the proper fuel filler cap, excessive pressure or vacuum in the fuel tank may damage the fuel system or cause the fuel cap to disengage in a collision, which may result in possible personal injury.

FFV (Flex Fuel Vehicle) fuel cap

If your vehicle is FFV capable, it will have a yellow colored fuel cap.

FORD RECOMMENDS BP



Choosing the right fuel

If your vehicle is a flexible fuel vehicle (FFV), use only UNLEADED FUEL and FUEL ETHANOL (E85).

If your vehicle is not a flexible fuel vehicle (FFV), then only use UNLEADED fuel or UNLEADED fuel blended with a maximum of 10% ethanol. Do not use fuel ethanol (E85), diesel, methanol, leaded fuel or any other fuel.

The use of leaded fuel is prohibited by law and could damage your vehicle.

Your vehicle was not designed to use fuel or fuel additives with metallic compounds, including manganese-based additives.

Note: Use of any fuel other than those recommended may cause powertrain damage, a loss of vehicle performance, and repairs may not be covered under warranty.

Maintenance and Specifications

Octane recommendations

Your vehicle is designed to use “Regular” unleaded gasoline with a pump (R+M)/2 octane rating of 87. Some stations offer fuels posted as “Regular” with an octane rating below 87, particularly in high altitude areas. Fuels with octane levels below 87 are not recommended.

Do not be concerned if your engine sometimes knocks lightly. However, if it knocks heavily under most driving conditions while you are using fuel with the recommended octane rating, see your authorized dealer to prevent any engine damage.

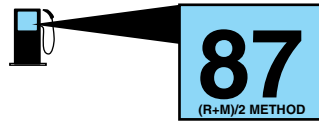

FFV engine (if equipped)

If your vehicle is flex fuel capable, it is designed to use Fuel Ethanol (E85), “Regular” unleaded gasoline or any mixture of the two fuels.

Use of other fuels such as Fuel Methanol may cause powertrain damage, a loss of vehicle performance, and your warranty may be invalidated.

It is best not to alternate repeatedly between gasoline and E85. If you do switch fuels, it is recommended that you add as much fuel as possible—at least half a tank. Do not add less than five gallons (18.9L) when refueling. You should drive the vehicle immediately after refueling for at least 5 miles (8 km) to allow the vehicle to adapt to the change in ethanol concentration.

If you exclusively use E85 fuel, it is recommended to fill the fuel tank with regular unleaded gasoline at each scheduled oil change.

Fuel quality

Unleaded gasoline engines

If you experience starting, rough idle, hesitation or driveability problems during a cold start, try a different brand of “Regular” unleaded gasoline. “Premium” unleaded gasoline is not recommended for vehicles designed to use “Regular” unleaded gasoline because it may cause these problems to become more pronounced. If the problems persist, see your authorized dealer.

FFV engines

If you experience starting, rough idle, hesitation or driveability problems during a cold start, try a different brand of E85 fuel. If the driveability problems continue, fill the vehicle with regular unleaded gasoline and drive vehicle normally until gasoline is used. See your authorized dealer if the problem persists.

382

Maintenance and Specifications

Do not add aftermarket fuel additive products to your fuel tank. It should not be necessary to add any aftermarket products to your fuel tank if you continue to use high quality fuel of the recommended octane rating. These products have not been approved for your engine and could cause damage to the fuel system. Repairs to correct the effects of using an aftermarket product in your fuel may not be covered by your warranty.

Many of the world's automakers approved the World-Wide Fuel Charter that recommends gasoline specifications to provide improved performance and emission control system protection for your vehicle. Gasolines that meet the World-Wide Fuel Charter should be used when available. Ask your fuel supplier about gasolines that meet the World-Wide Fuel Charter.

Diesel engine (if equipped)

Refer to the diesel supplement for information regarding diesel fuel recommendations and requirements of your diesel-powered truck.



Cleaner air

Ford endorses the use of reformulated "cleaner-burning" gasolines to improve air quality, per the recommendations in the *Choosing the right fuel* section.

Running out of fuel

Avoid running out of fuel because this situation may have an adverse effect on powertrain components.

If you have run out of fuel:

- You may need to cycle the ignition from off to on several times after refueling to allow the fuel system to pump the fuel from the tank to the engine. On restarting, cranking time will take a few seconds longer than normal.
- Normally, adding 1 gallon (3.8L) of fuel is enough to restart the engine. If the vehicle is out of fuel and on a steep grade, more than 1 gallon (3.8L) may be required.
- The service engine soon  indicator may come on. For more information on the service engine soon  indicator, refer to *Warning lights and chimes* in the *Instrument Cluster* chapter.

Maintenance and Specifications

ESSENTIALS OF GOOD FUEL ECONOMY

Measuring techniques

Your best source of information about actual fuel economy is you, the driver. You must gather information as accurately and consistently as possible. Fuel expense, frequency of fill-ups or fuel gauge readings are NOT accurate as a measure of fuel economy. We do not recommend taking fuel economy measurements during the first 1,000 miles (1,600 km) of driving (engine break-in period). You will get a more accurate measurement after 2,000 miles–3,000 miles (3,000 km–5,000 km).

Filling the tank

The advertised fuel capacity of the fuel tank on your vehicle is equal to the rated refill capacity of the fuel tank as listed in the *Maintenance product specifications and capacities* section of this chapter.

The advertised capacity is the amount of the indicated capacity and the empty reserve combined. Indicated capacity is the difference in the amount of fuel in a full tank and a tank when the fuel gauge indicates empty. Empty reserve is the small amount of fuel remaining in the fuel tank after the fuel gauge indicates empty.

The amount of usable fuel in the empty reserve varies and should not be relied upon to increase driving range. When refueling your vehicle after the fuel gauge indicates empty, you might not be able to refuel the full amount of the advertised capacity of the fuel tank due to the empty reserve still present in the tank.

For consistent results when filling the fuel tank:

- Turn the engine/ignition switch to the off position prior to refueling, an error in the reading will result if the engine is left running.
- Use the same filling rate setting (low — medium — high) each time the tank is filled.
- Allow no more than two automatic click-offs when filling.
- Always use fuel with the recommended octane rating.
- Use a known quality gasoline, preferably a national brand.
- Have the vehicle loading and distribution the same every time.

Your results will be most accurate if your filling method is consistent.

Maintenance and Specifications

Calculating fuel economy

1. Fill the fuel tank completely and record the initial odometer reading (in miles or kilometers).
2. Each time you fill the tank, record the amount of fuel added (in gallons or liters).
3. After at least three to five tank fill-ups, fill the fuel tank and record the current odometer reading.
4. Subtract your initial odometer reading from the current odometer reading.
5. Follow one of the simple calculations in order to determine fuel economy:

Calculation 1: **Divide total miles traveled by total gallons used.**

Calculation 2: **Multiply liters used by 100, then divide by total kilometers traveled.**

Keep a record for at least one month and record the type of driving (city or highway). This will provide an accurate estimate of the vehicle's fuel economy under current driving conditions. Additionally, keeping records during summer and winter will show how temperature impacts fuel economy. In general, lower temperatures give lower fuel economy.

Driving style — good driving and fuel economy habits

Give consideration to the lists that follow and you may be able to change a number of variables and improve your fuel economy.

Habits

- Smooth, moderate operation can yield up to 10% savings in fuel.
- Steady speeds without stopping will usually give the best fuel economy.
- Idling for long periods of time (greater than one minute) may waste fuel.
- Anticipate stopping; slowing down may eliminate the need to stop.
- Sudden or hard accelerations may reduce fuel economy.
- Slow down gradually.
- Driving at reasonable speeds (traveling at 55 mph [88 km/h] uses 15% less fuel than traveling at 65 mph [105 km/h]).
- Revving the engine before turning it off may reduce fuel economy.
- Using the air conditioner or defroster may reduce fuel economy.
- You may want to turn off the speed control in hilly terrain if unnecessary shifting between the top gears occurs. Unnecessary shifting of this type could result in reduced fuel economy.

Maintenance and Specifications

- Warming up a vehicle on cold mornings is not required and may reduce fuel economy.
- Resting your foot on the brake pedal while driving may reduce fuel economy.
- Combine errands and minimize stop-and-go driving.

Maintenance

- Keep tires properly inflated and use only recommended size.
- Operating a vehicle with the wheels out of alignment will reduce fuel economy.
- Use recommended engine oil. Refer to *Maintenance product specifications and capacities* in this chapter.
- Perform all regularly scheduled maintenance items. Follow the recommended maintenance schedule and owner maintenance checks found in *scheduled maintenance information*.

Conditions

- Heavily loading a vehicle or towing a trailer may reduce fuel economy at any speed.
- Carrying unnecessary weight may reduce fuel economy (approximately 1 mpg [0.4 km/L] is lost for every 400 lb [180 kg] of weight carried).
- Adding certain accessories to your vehicle (for example bug deflectors, rollbars/light bars, running boards, ski/luggage racks) may reduce fuel economy.
- To maximize the fuel economy, drive with the tonneau cover installed (if equipped).
- Using fuel blended with alcohol may lower fuel economy.
- Fuel economy may decrease with lower temperatures during the first 8–10 miles (12–16 km) of driving.
- Driving on flat terrain offers improved fuel economy as compared to driving on hilly terrain.
- Transmissions give their best fuel economy when operated in the top cruise gear and with steady pressure on the gas pedal.
- Four-wheel-drive operation (if equipped) is less fuel efficient than two-wheel-drive operation.
- Close windows for high speed driving.

Maintenance and Specifications

EMISSION CONTROL SYSTEM

Your vehicle is equipped with various emission control components and a catalytic converter which will enable your vehicle to comply with applicable exhaust emission standards. To make sure that the catalytic converter and other emission control components continue to work properly:

- Use only the specified fuel listed.
- Avoid running out of fuel.
- Do not turn off the ignition while your vehicle is moving, especially at high speeds.
- Have the items listed in *scheduled maintenance information* performed according to the specified schedule.

The scheduled maintenance items listed in *scheduled maintenance information* are essential to the life and performance of your vehicle and to its emissions system.

If other than Ford, Motorcraft® or Ford-authorized parts are used for maintenance replacements or for service of components affecting emission control, such non-Ford parts should be equivalent to genuine Ford Motor Company parts in performance and durability.



WARNING: Do not park, idle, or drive your vehicle in dry grass or other dry ground cover. The emission system heats up the engine compartment and exhaust system, which can start a fire.

Illumination of the service engine soon  indicator, charging system warning light or the temperature warning light, fluid leaks, strange odors, smoke or loss of engine power could indicate that the emission control system is not working properly.

An improperly operating or damaged exhaust system may allow exhaust to enter the vehicle. Have a damaged or improperly operating exhaust system inspected and repaired immediately.





WARNING: Exhaust leaks may result in entry of harmful and potentially lethal fumes into the passenger compartment.

Maintenance and Specifications

Do not make any unauthorized changes to your vehicle or engine. By law, vehicle owners and anyone who manufactures, repairs, services, sells, leases, trades vehicles, or supervises a fleet of vehicles are not permitted to intentionally remove an emission control device or prevent it from working. Information about your vehicle's emission system is on the Vehicle Emission Control Information Decal located on or near the engine. This decal also lists engine displacement.



Please consult your *Warranty Guide* for complete emission warranty information.

On-board diagnostics (OBD-II)

Your vehicle is equipped with a computer that monitors the engine's emission control system. This system is commonly known as the on-board diagnostics system (OBD-II). The OBD-II system protects the environment by ensuring that your vehicle continues to meet government emission standards. The OBD-II system also assists your authorized dealer in properly servicing your vehicle. When the service engine soon  indicator illuminates, the OBD-II system has detected a malfunction. Temporary malfunctions may cause the service engine soon  indicator to illuminate. Examples are:

1. The vehicle has run out of fuel—the engine may misfire or run poorly.
2. Poor fuel quality or water in the fuel—the engine may misfire or run poorly.
3. The fuel cap may not have been securely tightened. See *Fuel filler cap* in this chapter.
4. Driving through deep water—the electrical system may be wet.

These temporary malfunctions can be corrected by filling the fuel tank with good quality fuel, properly tightening the fuel cap or letting the electrical system dry out. After three driving cycles without these or any other temporary malfunctions present, the service engine soon  indicator should stay off the next time the engine is started. A driving cycle consists of a cold engine startup followed by mixed city/highway driving. No additional vehicle service is required.

If the service engine soon  indicator remains on, have your vehicle serviced at the first available opportunity. Although some malfunctions detected by the OBD-II may not have symptoms that are apparent, continued driving with the service engine soon  indicator on can result in increased emissions, lower fuel economy, reduced engine and transmission smoothness, and lead to more costly repairs.



388

Maintenance and Specifications

Readiness for Inspection/Maintenance (I/M) testing

Some state/provincial and local governments may have Inspection/Maintenance (I/M) programs to inspect the emission control equipment on your vehicle. Failure to pass this inspection could prevent you from getting a vehicle registration. Your vehicle may not pass the I/M test if the service engine soon  indicator is on or not working properly (bulb is burned out), or if the OBD-II system has determined that some of the emission control systems have not been properly checked. In this case, the vehicle is considered not ready for I/M testing.

If the service engine soon  indicator is on or the bulb does not work, the vehicle may need to be serviced. Refer to *On-board diagnostics (OBD-II)* in this chapter.

If the vehicle's engine or transmission has just been serviced, or the battery has recently run down or been replaced, the OBD-II system may indicate that the vehicle is not ready for I/M testing. To determine if the vehicle is ready for I/M testing, turn the ignition key to the on position for 15 seconds without cranking the engine. If the service engine soon  indicator blinks eight times, it means that the vehicle is not ready for I/M testing; if the service engine soon  indicator stays on solid, it means that the vehicle is ready for I/M testing.

The OBD-II system is designed to check the emission control system during normal driving. A complete check may take several days. If the vehicle is not ready for I/M testing, the following driving cycle consisting of mixed city and highway driving may be performed:

15 minutes of steady driving on an expressway/highway followed by 20 minutes of stop-and-go driving with at least four 30-second idle periods.

Allow the vehicle to sit for at least eight hours without starting the engine. Then, start the engine and complete the above driving cycle. The engine must warm up to its normal operating temperature. Once started, do not turn off the engine until the above driving cycle is complete. If the vehicle is still not ready for I/M testing, the above driving cycle will have to be repeated.

Maintenance and Specifications

POWER STEERING FLUID

Check the power steering fluid. Refer to *scheduled maintenance information*. If adding fluid is necessary, use only MERCON® ATF.

- Gasoline engine shown; diesel engine similar. Refer to *Identifying components in the engine compartment* in the diesel supplement.

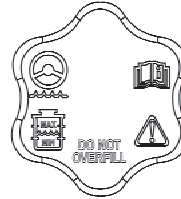

Check the fluid level when it is at ambient temperature, 20°F–80°F (-7°C–25°C):

1. Check the fluid level in the reservoir. It should be between the MIN and MAX range. Do not add fluid if the level is within this range.
2. If the fluid level is low. Add fluid to bring fluid level up to be between the MIN and MAX range.
3. Start the engine.
4. While the engine idles, turn the steering wheel left and right several times.
5. Turn the engine off.
6. Recheck the fluid level in the reservoir. Do not add fluid if the level is between the MIN and MAX range.
7. If the fluid is low, add fluid in small amounts, continuously checking the level until it is between the MIN and MAX range. Refer to *Maintenance products specifications and capacities* in this chapter for the proper fluid type. Be sure to put the cap back on the reservoir.

Maintenance and Specifications

BRAKE FLUID

- Vacuum boost system

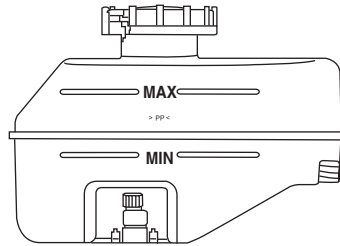

- Hydroboost system

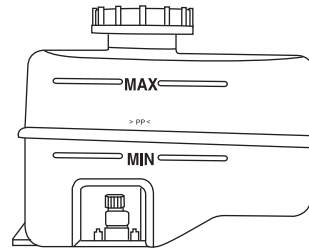

The fluid level will drop slowly as the brakes wear, and will rise when the brake components are replaced. Fluid levels between the top of the MIN and MAX lines are within the normal operating range; there is no need to add fluid. If the fluid levels are outside of the normal operating range, the performance of your brake system could be compromised; seek service from your authorized dealer immediately.

TRANSMISSION FLUID

Checking automatic transmission fluid (if equipped)

Refer to your *scheduled maintenance information* for scheduled intervals for fluid checks and changes. Your transmission does not consume fluid. However, the fluid level should be checked if the transmission is not working properly, i.e., if the transmission slips or shifts slowly or if you notice some sign of fluid leakage.

Automatic transmission fluid expands when warmed. To obtain an accurate fluid check, drive the vehicle until it is at normal operating temperature (approximately 20 miles [30 km]). Verify that the transmission fluid temperature gauge, located on the instrument cluster, is within normal range.

1. Drive the vehicle 20 miles (30 km) or until it reaches normal operating temperature.

Maintenance and Specifications

2. Park the vehicle on a level surface and engage the parking brake.
3. With the parking brake engaged and your foot on the brake pedal, start the engine and move the gearshift lever through all of the gear ranges. Allow sufficient time for each gear to engage.
4. Latch the gearshift lever in P (Park) and leave the engine running.
5. Remove the dipstick, wiping it clean with a clean, dry lint free rag. If necessary, refer to *Identifying components in the engine compartment* in this chapter for the location of the dipstick.
6. Install the dipstick making sure it is fully seated in the filler tube.
7. Remove the dipstick and inspect the fluid level. The fluid should be in the designated area for normal operating temperature or ambient temperature.

Low fluid level

Do not drive the vehicle if the fluid level is at the bottom of the dipstick and the ambient temperature is above 50°F (10°C).



Correct fluid level

For vehicles equipped with 5-speed transmissions, the fluid should be checked at normal operating temperature 150°F-170°F (66°C-77°C) on a level surface. For vehicles equipped with 6-speed transmissions, the fluid should be checked at normal operating temperature 180°F-200°F (82°C-93°C) on a level surface. The normal operating temperature can be reached after approximately 20 miles (30 km) of driving.

You can check the fluid without driving if the ambient temperature is above 50°F (10°C). However, if fluid is added at this time, an overfill condition could result when the vehicle reaches normal operating temperature.

For vehicles equipped with 5-speed transmissions, the transmission fluid should be in this range if at normal operating temperature (150°F-170°F [66°C-77°C]). For vehicles equipped with 6-speed transmissions, the transmission fluid should be in this range if at normal operating temperature (180°F-200°F [82°C-93°C]).

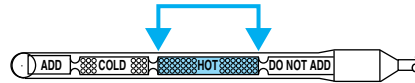

Maintenance and Specifications

The transmission fluid should be in this range if at ambient temperature (50°F-95°F [10°C-35°C]).



High fluid level

Fluid levels above the safe range may result in transmission failure. An overfill condition of transmission fluid may cause shift and/or engagement concerns and/or possible damage.



High fluid levels can be caused by an overheating condition.

Adjusting automatic transmission fluid levels

Before adding any fluid, make sure the correct type is used. The type of fluid used is normally indicated on the dipstick handle and also in the *Maintenance product specifications and capacities* section in this chapter.

Use of a non-approved automatic transmission fluid may cause internal transmission component damage.

If necessary, add fluid in 1/2 pint (250 ml) increments through the filler tube until the level is correct.

If an overfill occurs, excess fluid should be removed by a qualified technician.



An overfill condition of transmission fluid may cause shift and/or engagement concerns and/or possible damage.

Do not use supplemental transmission fluid additives, treatments or cleaning agents. The use of these materials may affect transmission operation and result in damage to internal transmission components.

Maintenance and Specifications

TRANSFER CASE FLUID (IF EQUIPPED)

1. Clean the filler plug.
2. Remove the filler plug and inspect the fluid level.

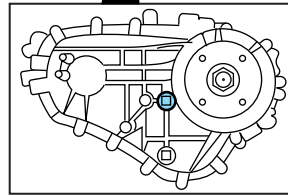
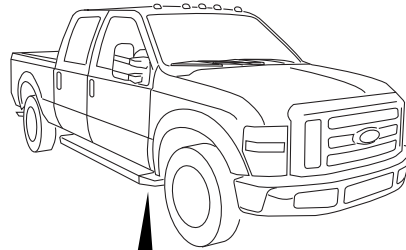

3. Add only enough fluid through the filler opening so that the fluid level is at the bottom of the opening.

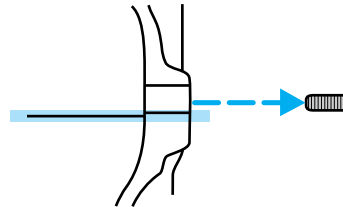

Use only fluid that meets Ford specifications. Refer to the *Maintenance product specifications and capacities* section in this chapter.

AIR FILTER

Refer to the *scheduled maintenance information* for the appropriate intervals for changing the air filter element.

When changing the air filter element, use only the Motorcraft® air filter element listed. Refer to *Motorcraft® part numbers* in this chapter.

394

Maintenance and Specifications

The following procedure is for vehicles equipped with a gasoline engine. If your vehicle is equipped with a diesel engine, refer to the diesel supplement.

Note: Do not start your engine with the air cleaner removed and do not remove it while the engine is running.

Changing the air filter element

1. Locate the mass air flow sensor electrical connector on the air outlet tube. This connector will need to be unplugged.

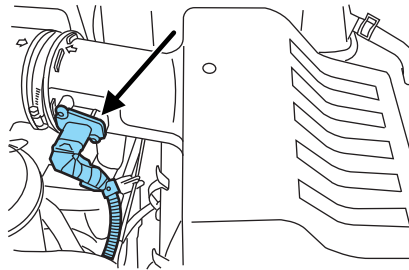

2. Reposition the locking clip on the connector (connector shown from below for clarity), squeeze the connector and pull it off of the air outlet tube.

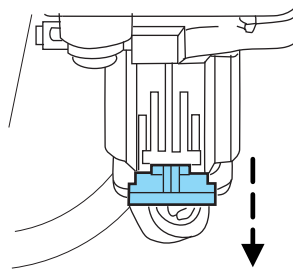

3. Clean the area around the air tube to air cover connection to prevent debris from entering the system and then loosen the bolt on the air tube clamp so the clamp is no longer snug to the air tube. It is not necessary to completely remove the clamp.

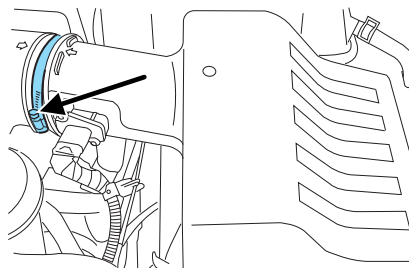

4. Pull the air tube off from the air cleaner housing.

Maintenance and Specifications

5. Release the three clamps that secure the cover to the air filter housing. Push the air filter cover toward the center of the vehicle and up slightly to release it.

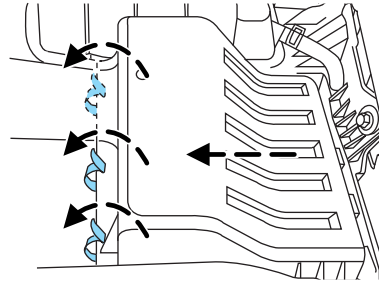

6. Remove the air filter element from the air filter housing.

7. Install a new air filter element.

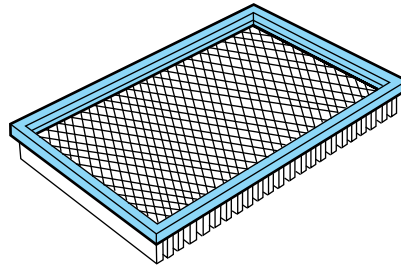

8. Replace the air filter housing cover and secure the clamps. Be careful not to crimp the filter element edges between the air filter housing and cover and ensure that the tabs on the edge are properly aligned into the slots.

9. Slip the air tube onto the air filter housing and tighten the air-tube clamp bolt snugly, but do not overtighten it.

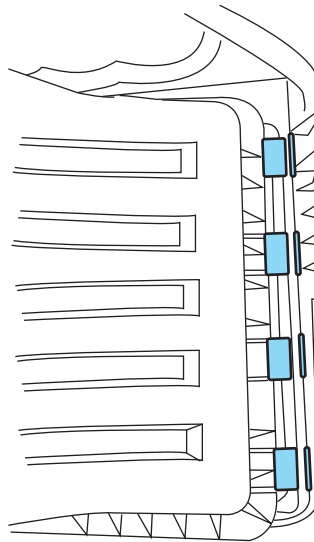

Maintenance and Specifications

10. Reconnect the mass air flow sensor electrical connector to the outlet tube. Make sure the locking tab on the connector is in the “locked” position (connector shown from below for clarity).

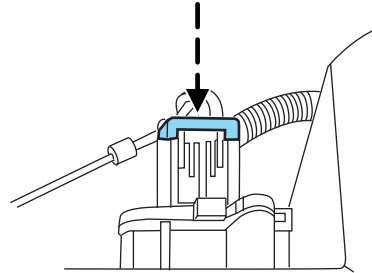

Note: Failure to use the correct air filter element may result in severe engine damage. The customer warranty may be void for any damage to the engine if the correct air filter element is not used.

VEHICLE STORAGE

If you plan on storing your vehicle for an extended period of time (30 days or more), refer to the following maintenance recommendations to ensure your vehicle stays in good operating condition.

All motor vehicles and their components were engineered and tested for reliable, regular driving. Long term storage under various conditions may lead to component degradation or failure unless specific precautions are taken to preserve the components.

General

- Store all vehicles in a dry, ventilated place.
- Protect from sunlight, if possible.
- If vehicles are stored outside, they require regular maintenance to protect against rust and damage.

Body

- Wash vehicle thoroughly to remove dirt, grease, oil, tar or mud from exterior surfaces, rear-wheel housing and underside of front fenders. See the *Cleaning* chapter for more information.
- Periodically wash vehicles stored in exposed locations.
- Touch-up raw or primed metal to prevent rust.
- Cover chrome and stainless steel parts with a thick coat of auto wax to prevent discoloration. Re-wax as necessary when the vehicle is washed. See the *Cleaning* chapter for more information.
- Lubricate all hood, door and trunk lid hinges, and latches with a light grade oil. See the *Cleaning* chapter for more information.

Maintenance and Specifications

- Cover interior trim to prevent fading.
- Keep all rubber parts free from oil and solvents.

Engine

- The engine oil and filter should be changed prior to storage, as used engine oil contain contaminants that may cause engine damage.
- Start the engine every 15 days. Run at fast idle until it reaches normal operating temperature.
- With your foot on the brake, shift through all the gears while the engine is running.

Fuel system

- Fill the fuel tank with high-quality fuel until the first automatic shutoff of the fuel pump nozzle.

Note: During extended periods of vehicle storage (30 days or more), fuel may deteriorate due to oxidation. This can damage rubber and other polymers in the fuel system and may also clog small holes.

A quality fuel stabilizer should be added whenever actual or expected storage periods exceed 30 days. Follow the instructions on the label. The vehicle should then be operated at idle speed to circulate the additive throughout the fuel system.

Cooling system

- Protect against freezing temperatures.

Battery

- Check and recharge as necessary. Keep connections clean and covered with a light coat of grease.
- If storing your vehicle for more than 30 days without recharging the battery, it may be advisable to disconnect the battery cables to ensure battery charge is maintained for quick starting.

Note: If battery cables are disconnected, it will be necessary to reset memory features.

Brakes

- Make sure brakes and parking brake are fully released.

Tires

- Maintain recommended air pressure.

Maintenance and Specifications

Miscellaneous

- Make sure all linkages, cables, levers and pins under vehicle are covered with grease to prevent rust.
- Move vehicles at least 25 feet (8 m) every 15 days to lubricate working parts and prevent corrosion.

Removing vehicle from storage

When your vehicle is ready to come out of storage, do the following:

- Wash your vehicle to remove any dirt or grease film build-up on window surfaces.
- Check windshield wipers for any deterioration.
- Check under the hood for any foreign material that may have collected during storage (mice/squirrel nests).
- Check the exhaust for any foreign material that may have collected during storage.
- Check tire pressures and set tire inflation per the Tire Label.
- Check brake pedal operation. Drive the vehicle 15 ft (4.5 meters) back and forth to remove rust build up.
- If the battery was removed, clean the battery cable ends and inspect.

If you have any concerns or issues, contact your authorized dealer.

MOTORCRAFT PART NUMBERS

Component	6.2L V8 engine	6.8L V10 engine
Air filter element	FA-1883	FA-1883
Oil filter	FL-820-S	FL-820-S
Battery (standard)	BXT-65-650	BXT-65-650
Battery (optional)	BXT-65-750	BXT-65-750
Spark plugs-platinum	1	

¹For spark plug replacement, see your authorized dealer. Refer to the *scheduled maintenance information* for the appropriate intervals for changing the spark plugs.

Replace the spark plugs with ones that meet Ford material and design specifications for your vehicle, such as Motorcraft® or equivalent replacement parts. The customer warranty may be void for any damage to the engine if such spark plugs are not used.

Maintenance and Specifications

MAINTENANCE PRODUCT SPECIFICATIONS AND CAPACITIES

Item	Capacity	Ford part name	Ford part number / Ford specification
Front axle	5.8 pints (2.8L)	Motorcraft® SAE 80W-90 Premium Rear Axle Lubricant	XY-80W-90-QL / WSP-M2C197-A
Spindle bearing	—	High Temperature 4X4 Front Axle and Wheel Bearing Grease	XG-11 / WSS-M1C267-A1
Rear axle - F-250/350 (10.50 inch axle) ¹	6.9 pints (3.3L)	Motorcraft® SAE 75W-140 Synthetic Rear Axle Lubricant	XY-75W140-QL / WSL-M2C192-A
Rear axle - F-350 (Dana M80)	8.5 pints (4.0L)	Motorcraft® SAE 75W-90 Synthetic Rear Axle Lubricant	XY-75W90-QLS / WSS-M2C918-A
Rear axle - F-450/550 (Dana S110/S130)	14.0 pints (6.6L)	Motorcraft® SAE 75W-140 Synthetic Rear Axle Lubricant	XY-75W140-QL / WSL-M2C192-A
Brake fluid	Fill to line on reservoir	Motorcraft® High Performance DOT 3 Motor Vehicle Brake Fluid	PM-1-C / WSS-M6C62-A or WSS-M6C65-A1

Maintenance and Specifications

Item	Capacity	Ford part name	Ford part number / Ford specification
Engine coolant (6.2L V8 engine) ²	21.3 quarts (20.2L)	Motorcraft® Specialty Orange Engine Coolant (orange-colored)	VC-3-B (US) / CVC-3-B (Canada) / WSS-M97B44-D
Engine coolant (6.8L V10 engine) ²	26.7 quarts (25.3L)		
Engine and fuel coolant - diesel engine		Refer to the diesel supplement.	
Engine oil (includes filter change) - 6.2L V8 and 6.8L V10 gas engines ⁵	7.0 quarts (6.6L)	<ul style="list-style-type: none"> • Motorcraft® SAE 5W-20 Premium Synthetic Blend Motor Oil (US) • Motorcraft® SAE 5W-20 Full Synthetic Motor Oil (US) • Motorcraft® SAE 5W-20 Super Premium Motor Oil (Canada) • Motorcraft® SAE 5W-20 Synthetic Motor Oil (Canada) 	<ul style="list-style-type: none"> • XO-5W20-QSP (US) • XO-5W20-QFS (US) • CXO-5W20-LSP12 (Canada) • CXO-5W-20-LFS12 (Canada) / WSS-M2C930-A and API Certification Mark
		Refer to the diesel supplement.	
Engine oil (includes filter change) - diesel engine		Refer to the diesel supplement.	
Fuel tank (mid-ship)	28 gallons (106L)	—	—
Fuel tank (plastic)	35 gallons (132L)	—	—
Fuel tank (Aft axle)	40 gallons (151L)	—	—

Maintenance and Specifications

Item	Capacity	Ford part name	Ford part number / Ford specification
Hinges, latches, striker plates, fuel filler door hinge and seat tracks	—	Multi-Purpose Grease	XG-4 or XL-5 / ESB-M1C93-B
Lock cylinders	—	Motorcraft® Penetrating and Lock Lubricant	XL-1 / None
Transmission / parking brake linkages and pivots, brake pedal shift	—	Motorcraft® Premium Long-Life Grease	XG-1-C or XG-1-K / WSD-M1C227-A
Power steering fluid	Keep fluid level between MIN and MAX on reservoir	Motorcraft® MERCOR® V ATF	XT-5-QM / MERCOR® V
Transfer case fluid	2.0 quarts (1.9L)	Motorcraft® Transfer Case Fluid	XL-12 / —
Automatic transmission fluid (5-speed) ³	17.5 quarts (16.6L) ⁴	Motorcraft® MERCOR® LV ATF	XT-10-QLV / MERCOR® LV
Automatic transmission fluid (6-speed) ³	18.5 quarts (17.5L) ⁴		

Maintenance and Specifications

Item	Capacity	Ford part name	Ford part number / Ford specification
Windshield washer fluid	Fill as required	Motorcraft® Premium Windshield Washer Concentrate (US) Premium Quality Windshield Washer Fluid (Canada)	ZC-32-A (US) CXC-37-(A, B, D, and F) (Canada) / WSB-M8B16-A2 / - -

¹Add 8 oz. (236 ml) of Additive Friction Modifier XL-3 or equivalent meeting Ford Specification EST-M2C118-A for complete refill of limited slip Ford axles. Ford design rear axles contain a synthetic lubricant that does not require changing unless the axle has been submerged in water.

²Add the coolant type originally equipped in your vehicle.

³Ensure the correct automatic transmission fluid is used. Transmission fluid requirements are indicated on the dipstick blade or the dipstick handle. Check the container to verify the fluid being added is of the correct type. Refer to your *scheduled maintenance information* to determine the correct service interval.

Automatic transmissions that require MERCON® LV should only use MERCON® LV fluid. Use of any fluid other than the recommended fluid may cause transmission damage.

⁴Indicates only approximate dry-fill capacity. Some applications may vary based on cooler size and if equipped with an in-tank cooler. The amount of transmission fluid and fluid level should be set by the indication on the dipstick's normal operating range.

⁵Use of synthetic or synthetic blend motor oil is not mandatory. Engine oil need only meet the requirements of Ford specification WSS-M2C930-A and the API Certification mark.

Maintenance and Specifications

ENGINE DATA

Engine	6.2L V8 engine	6.8L V10 engine
Cubic inches	378	413
Required fuel	87 octane	87 octane
Firing order	1-3-7-2-6-5-4-8	1-6-5-10-2-7-3-8-4-9
Spark plug gap	0.039–0.043 inch (1.0–1.1mm)	0.039–0.043 inch (1.0–1.1mm)
Ignition system	Coil on plug	Coil on plug
Compression ratio	9.8:1	9.2:1

Engine drivebelt routing

6.2L V8 engine

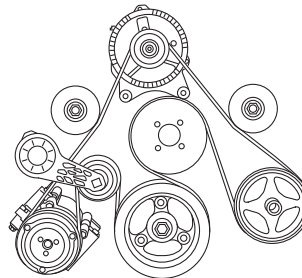

6.8L V10 engine with A/C

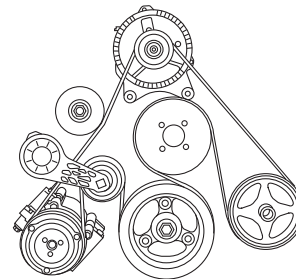

Maintenance and Specifications

6.8L V10 engine - without A/C

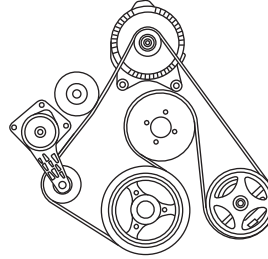

IDENTIFYING YOUR VEHICLE

Safety Compliance Certification Label

The National Highway Traffic Safety Administration Regulations require that a Safety Compliance Certification Label be affixed to a vehicle and prescribe where the Safety Compliance Certification Label may be located. The Safety Compliance Certification Label is located on the structure by the trailing edge of the driver's door or the edge of the driver's door.

MFD. BY FORD MOTOR CO. IN U.S.A.			
DATE: XXXXX	GVWR: XXXXX LB/ XXXXX KG		
FGAWR: XXXXXX/XXXXXXXX	RGAWR: XXXXXX/XXXXXXXX		
THIS VEHICLE CONFORMS TO ALL APPLICABLE FEDERAL MOTOR VEHICLE SAFETY STANDARDS IN EFFECT ON THE DATE OF MANUFACTURE SHOWN ABOVE.			
VIN: XXXXXXXXXXXXXXXXXXXX	TYPE: XXXXXXXXXXXXXXXXXXXX		
MAXIMUM LOAD=OCCUPANTS + LUGGAGE=XXXKG/XXXLB			
OCCUPANTS: X TOTAL X FR X 2ND X RR OCCUPANTS LUGGAGE			
XX XXXKG/XXXLB			
X XXXKG/XXXLB			
TIRE: XXXX/XXXXX XXX			
PRESSURE (FR) XXX kPa/ XX PSI COLD			
PRESSURE (RR) XXX kPa/ XX PSI COLD			
<small>TRAILER TOWING - SEE OWNER GUIDE</small>			
EXT PNT: XXXXXX XXXXXX	RC: XX	D5O: XXXX	F0000
BAR INT TR TP/PS R	AXLE TR SPR	T0000	
X XX XXX X	XX X XXXX		

Maintenance and Specifications

Vehicle identification number (VIN)

The vehicle identification number is located on the driver side instrument panel.

Please note that in the graphic, XXXX is representative of your vehicle identification number.

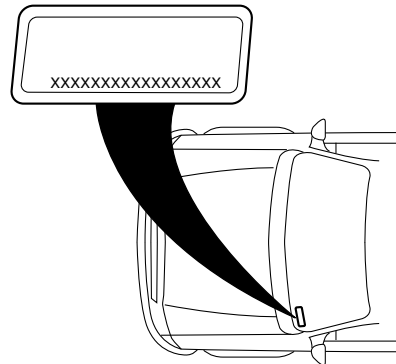

The Vehicle Identification Number (VIN) contains the following information:

1. World manufacturer identifier
2. Brake system / Gross Vehicle Weight Rating (GVWR) / Restraint Devices and their location
3. Make, vehicle line, series, body type
4. Engine type
5. Check digit
6. Model year
7. Assembly plant
8. Production sequence number

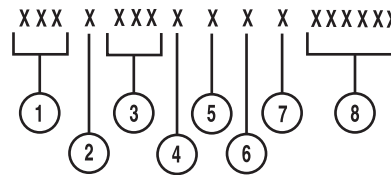

Maintenance and Specifications

TRANSMISSION CODE DESIGNATIONS

You can find a transmission code on the Safety Compliance Certification Label. The following table tells you which transmission each code represents.

MFD. BY FORD MOTOR CO.					
DATE: XXXX	GVWR: XXXXXLB/ XXXXXKG				
FRONT GAWR: XXXXL	REAR GAWR: XXXXLB				
XXXXKG	WITH XXXXKG	WITH			
XXXXXX/XXXXXX	TIRES: XXXX/XXXXXX	TIRES			
XXXX.XX	RIMS: XXXX.XX	RIMS			
AT XXX kPa/XX	PSI COLD	AT XXX kPa/XX	PSI COLD		
THIS VEHICLE CONFORMS TO ALL APPLICABLE FEDERAL MOTOR VEHICLE SAFETY AND THEFT PREVENTION STANDARDS IN EFFECT ON THE DATE OF MANUFACTURE SHOWN ABOVE.					
VIN: XXXXXXXXXXXXXXXXX	XXXXX				
TYPE: XXX	XXXXX				
					
EXT PNT: XX	RC: XX	DSD:			
WB ¹ BRK ¹	INT TR ¹	TP/PS ¹	R ¹	AXLE ¹	TR ¹ SPR ¹ XXXXX
XXX X	XX	X	XX	X	XX XXX
XXXXXXXXXXXXX XX XXXX-XXXXXX-XX					

Code	Description
T	Five-speed automatic (5R110W)
P	Six-speed automatic (6R140)

Accessories

FORD CUSTOM ACCESSORIES FOR YOUR VEHICLE

A wide selection of Ford Custom Accessories are available for your vehicle through your local Ford or Ford of Canada dealer. These quality accessories have been specifically engineered to fulfill your automotive needs; they are custom designed to complement the style and aerodynamic appearance of your vehicle. In addition, each accessory is made from high quality materials and meets or exceeds Ford's rigorous engineering and safety specifications. Ford Motor Company will repair or replace any properly dealer-installed Ford Custom Accessories found to be defective in factory-supplied materials or workmanship during the warranty period, as well as any component damaged by the defective accessories. The accessories will be warranted for whichever provides you the greatest benefit:

- 12 months or 12,000 miles (20,000 km) (whichever occurs first), or
- the remainder of your new vehicle limited warranty.

Contact your dealer for details and a copy of the warranty.

The following is a list of several Ford Custom Accessories. Not all accessories are available for all models. For a complete listing of the accessories that are available for your vehicle, please contact your dealer or visit our online store at: www.fordaccessories.com.

Exterior style

- Bug shields
- Chrome exhaust tips
- Deflectors
- Running boards
- Splash guards
- Step bars
- Wheels
- Custom graphics*
- Stainless steel wheel covers*

Interior style

- Floor mats
- Custom seat covers*
- Electrochromic compass/temperature interior mirrors

Accessories

Lifestyle

- Ash cup / smoker's package
- Bedliners and bedmats
- Subwoofer*
- Towing mirrors
- Navigation*
- Tonneau covers*
- Racks and carriers*
- Truck bed camping tent*
- Sportliner cargo liner*
- Trailer hitch balls*
- Rear seat entertainment*
- Trailer hitches, wiring harnesses and accessories

Peace of mind

- Keyless entry keypad
- Remote start
- Vehicle security systems
- Wheel locks
- Vehicle tracking and recovery*
- Protective seat covers*
- Bumper and hitch mounted parking sensors*
- Back up camera*
- Back up alarm*
- Cable lock*
- Bed hooks*
- Tool/Cargo boxes*
- Windshield wiper shaker*

Not all accessories are available for all models.

*Ford Licensed Accessories (FLA) are warranted by the accessory manufacturer's warranty. Ford Licensed Accessories are fully designed and developed by the accessory manufacturer and have not been designed or tested to Ford Motor Company engineering requirements. Contact your Ford dealer for details regarding the manufacturer's limited warranty and/or a copy of the FLA product limited warranty offered by the accessory manufacturer.

For maximum vehicle performance, keep the following information in mind when adding accessories or equipment to your vehicle:

- When adding accessories, equipment, passengers and luggage to your vehicle, do not exceed the total weight capacity of the vehicle or of the front or rear axle (GVWR or GAWR as indicated on the Safety Compliance Certification Label). Consult your authorized dealer for specific weight information.
- The Federal Communications Commission (FCC) and Canadian Radio Telecommunications Commission (CRTC) regulate the use of mobile communications systems — such as two-way radios, telephones and theft alarms - that are equipped with radio transmitters. Any such equipment installed in your vehicle should comply with FCC or CRTC regulations and should be installed only by your authorized dealer.

Accessories

- Mobile communications systems may harm the operation of your vehicle, particularly if they are not properly designed for automotive use.
- To avoid interference with other vehicle functions, such as anti-lock braking systems, amateur radio users who install radios and antennas onto their vehicle should not locate the Amateur Radio Antennas in the area of the driver's side hood.
- Electrical or electronic accessories or components that are added to the vehicle by the authorized dealer or the owner may adversely affect battery performance and durability.

Ford Extended Service Plan

FORD ESP EXTENDED SERVICE PLANS (U.S. ONLY)

More than 30 million Ford, Lincoln, and Mercury owners have discovered the powerful protection of Ford ESP. It is the only extended service plan backed by Ford Motor Company, and provides “peace of mind” protection beyond the New Vehicle Limited Warranty coverage.

Up to 500+ Covered Vehicle Components

There are four, new-vehicle Extended Service Plans with different levels of coverage. Ask your dealer for details.

PremiumCare – Our most comprehensive coverage. With over 500 covered components, this plan is so complete that we generally only discuss what’s not covered!

ExtraCare – Covers 113 components, and includes many high-tech items.

BaseCare – Covers 84 components.

PowertrainCare – Covers 29 critical components.

Ford ESP is honored by all Ford, Lincoln and Mercury Dealers in the U.S. and Canada It’s the only extended service plan authorized and backed by Ford Motor Company. That means you get:

- Reliable, quality service anywhere you go.
- **Factory-trained technicians.**
- **Genuine Ford and Motorcraft® Parts.**

Rental car reimbursement

If your vehicle is kept overnight for covered repairs, you are eligible for rental car coverage, including Bumper-to-Bumper warranty repairs, or manufacturer’s recalls.

Transferable coverage

If you sell your vehicle before your Ford ESP coverage expires, you can transfer any remaining coverage to the new owner. Whenever you’re ready to sell your car, prospective buyers may feel better about taking a risk on your used vehicle. Ford ESP may add resale value!

Plus, **exclusive 24/7 roadside assistance**, including:

- Towing, flat-tire change and battery jump starts.
- Out-of-fuel and lock-out assistance.
- Travel expense reimbursement for lodging, meals and rental car.
- Destination assistance for taxi, shuttle, rental car coverage and emergency transportation.

Ford Extended Service Plan

Ford ESP Can Quickly Pay for Itself

One service bill – the cost of parts and labor – can easily exceed the price of your Ford ESP Service Contract. With Ford ESP, you minimize your risk for unexpected repair bills and rising repair costs.

Avoid the rising cost of properly maintaining your vehicle!

Ford ESP also offers a Premium Maintenance Plan that covers items that **routinely wear out**.

The coverage is prepaid, so you never have to worry about affording your vehicle maintenance. It covers regular checkups, routine inspections, preventive care and replacement of items that require periodic attention for **normal “wear”**:

- **Wiper blades**
- **Spark plugs (except California)**
- **Clutch disc**
- **Brake pads and linings**
- **Shock absorbers**
- **Belts and hoses**

Contact your selling Ford, Lincoln, or Mercury dealership today so they can customize a Ford Extended Service Plan that fits your driving lifestyle and budget.

Interest free finance options available

Take advantage of our installment payment plan, just a 10% down payment will provide you with an affordable no interest, no-fee payment opportunity.

Ford Extended Service Plan

Get Genuine Peace of Mind with Ford ESP!

To learn more, complete the information below and mail this to:

**Ford ESP
P.O. Box 8072
Royal Oak, MI 48068-9933**

NAME (PLEASE PRINT) _____
ADDRESS _____ APT.NO. _____
CITY _____ STATE _____ ZIP _____
E-MAIL: _____

Ford Extended Service Plan

FORD ESP EXTENDED SERVICE PLANS (CANADA ONLY)

You can get more protection for your vehicle by purchasing a Ford Extended Service Plan (ESP). Ford ESP is the only service contract backed by Ford Motor Company. Depending on the plan you purchase, Ford ESP provides benefits such as:

- Rental reimbursement
- Coverage for certain maintenance and wear items
- Protection against repair costs after your New Vehicle Limited Warranty Coverage expires
- Roadside Assistance benefits

You may purchase Ford ESP from any participating Ford Motor Company dealership. There are several Ford ESP plans available in various time, distance and deductible combinations. Each plan is tailored to fit your own driving needs, including reimbursement for towing and rental.

When you purchase Ford ESP, you receive peace-of-mind protection throughout Canada and the United States, provided by a network of Ford Motor Company dealers.

For more information, visit your local Ford of Canada dealer or www.ford.ca to find the Ford Extended Service Plan that is right for you.

NOTE: Repairs performed outside of Canada and the United States are not eligible for Ford ESP coverage. This information is subject to change.

Scheduled Maintenance Guide

GENERAL MAINTENANCE INFORMATION

Why maintain your vehicle?

This guide describes the scheduled maintenance required for your vehicle. Carefully following this schedule helps protect against major repair expenses resulting from neglect or inadequate maintenance and may also help to increase the value of your vehicle when you sell or trade it.

It is your responsibility to see that all scheduled maintenance is performed and that the materials used meet Ford engineering specifications. Failure to perform scheduled maintenance specific in this guide will invalidate warranty coverage on parts affected by the lack of maintenance. Be sure receipts for completed maintenance are kept with the vehicle and confirmation of the work performed is always recorded in this guide.

Your Ford or Lincoln Mercury dealer has factory trained technicians who can perform the required maintenance using genuine Ford parts. They are committed to meeting your service needs and to assuring your continuing satisfaction.

Protecting your investment

Maintenance is an investment that will pay dividends in the form of improved reliability, durability and resale value. To ensure the proper performance of your vehicle and its emission control systems, it is imperative that scheduled maintenance be completed at the designated intervals.

Your vehicle is very sophisticated and built with multiple complex performance systems. Every manufacturer develops these systems using different specifications and performance features. That's why it's important to rely upon your Ford or Lincoln Mercury dealership to properly diagnose and repair your vehicle.

Ford Motor Company has recommended maintenance intervals for various parts and component systems based upon engineering testing. Ford Motor Company relies upon this testing to determine the most appropriate mileage for replacement of oils and fluids to protect your vehicle at the lowest overall cost to you and recommends against maintenance schedules that deviate from the scheduled maintenance information.

Ford strongly recommends the use of genuine Ford replacement parts. Parts other than Ford, Motorcraft® or Ford-authorized remanufactured parts that are used for maintenance replacement or for the service of components affecting emission control must be equivalent to genuine Ford Motor Company parts in performance and durability. It is the owner's responsibility to determine the equivalency of such parts. Please consult your *Warranty Guide* for complete warranty information.

Scheduled Maintenance Guide

Non-Ford approved chemicals or additives are not required for factory recommended maintenance. In fact, Ford Motor Company recommends against the use of such additive products unless specifically recommended by Ford for a particular application.

Oil, fluids and flushing

In many cases, fluid discoloration is a normal operating characteristic and, by itself, does not necessarily indicate a concern or that the fluid needs to be changed. However, discolored fluids that also show signs of overheating and/or foreign material contamination should be inspected immediately by a qualified expert such as the factory-trained technicians at your Ford or Lincoln Mercury Dealership. Your vehicle's oils and fluids should be changed at the specified intervals or in conjunction with a repair. Flushing is a viable way to change fluid for many vehicle sub-systems during scheduled maintenance. It is critical that systems are flushed only with new fluid that is the same as that required to fill and operate the system, or using a Ford-approved flushing chemical.

Genuine Ford parts and service

When planning your maintenance services, consider your Ford and Lincoln Mercury dealership for all your vehicle's needs.

Get the most from your service and maintenance visits

There are a lot of reasons why visiting your Ford or Lincoln Mercury dealership for all your service needs is a great way to help keep your vehicle running great.

Convenience

Many dealerships have extended evening and Saturday hours to make your service visit more convenient. How's that for quality service?

Factory-trained technicians

Ford and Lincoln Mercury service technicians participate in extensive factory-sponsored certification training to help them become experts on the operation of your vehicle. Ask your dealership about the training and certification their technicians have received.

Genuine Ford and Motorcraft® replacement parts

Ford and Lincoln Mercury dealerships stock Ford and Motorcraft® branded replacement parts. These parts meet or exceed Ford Motor Company's specifications, and we stand behind them. Parts installed at your Ford or Lincoln Mercury dealership carry a nationwide, 12 months, 12,000 mile (20,000 km) parts and labor limited warranty. Your dealer can give you details.

416

Scheduled Maintenance Guide

Value shopping for your vehicle's maintenance needs

Your dealership recognizes the competitive landscape of maintenance and light repair automotive services. With factory-trained technicians, and one-stop service from routine maintenance like oil changes and tire rotations to repairs like brake service, check out the value your Ford and Lincoln Mercury dealers can offer.

WHICH MAINTENANCE SCHEDULE SHOULD YOU FOLLOW?

Owner checks and services

Certain basic maintenance checks and inspections should be performed by the owner or a service technician at the intervals indicated. Service information and supporting specifications are provided in this Owner's Guide.

Any adverse condition should be brought to the attention of your dealer or qualified service technician as soon as possible for the proper service advice. The owner maintenance service checks are generally not covered by warranties so you may be charged for labor, parts or lubricants used.

Maximum oil change interval

- 7,500 miles (12,000 km) or 6 months, whichever comes first

Engine coolant change interval

- 6 years or 105,000 miles (168,000 km) - change engine coolant (whichever comes first)
- After initial change - change engine coolant every 3 years or 45,000 miles (72,000 km).

Check every month

- Check function of all interior and exterior lights
- Check tires for wear and correct air pressure, including spare tire
- Check windshield washer fluid level
- Check engine oil level

Scheduled Maintenance Guide

Check every six months

- Check lap/shoulder belts and seat latches for wear and function
- Check parking brake for proper operation
- Check safety warning lamps (brake, ABS, airbag, safety belt) for operation
- Check cooling system fluid level and coolant strength
- Check battery connections and clean if necessary
- Check washer spray, wiper operation and clean all wiper blades (replace as necessary)
- Check and lubricate all hinges, latches and outside locks. Inspect for correct operation
- Check and lubricate door rubber weatherstrips. Inspect for excessive wear
- Check and clean body and door drain holes. Inspect for clogs and obstructions

Multi-point inspection

Ford recommended scheduled maintenance – In order to keep your vehicle running right, it is important to have the systems on your vehicle checked regularly. This can help identify potential issues and prevent major problems. Ford Motor Company recommends the following multi-point inspection be performed at every scheduled maintenance interval to help ensure your vehicle keeps running great.

MULTI-POINT INSPECTION - Recommended at every visit

- Check and top-up fluid levels: brake, coolant recovery reservoir, manual and automatic transmission (if equipped with an underhood dipstick), power steering (if equipped) and window washer
- Inspect tires for wear and check air pressure, including spare.
- Check exhaust system for leaks, damage, loose parts and foreign material.
- Check battery performance.
- Check operation of horn, exterior lamps, turn signals and hazard warning lights.
- Check radiator, coolers, heater and air conditioning hoses.
- Inspect windshield washer spray and wiper operation.
- Check windshield for cracks, chips and pitting.
- Inspect for oil and fluid leaks.
- Inspect engine air filter.
- Inspect half shaft dust boots, if equipped.
- Check shocks and struts and other suspension components for leaks and damage.
- Inspect steering and linkage.
- Inspect accessory drive belt(s).
- Inspect clutch operation, if equipped.

Be sure to ask your Ford or Lincoln Mercury dealership service advisor or technician about the multi-point vehicle inspection. It's a comprehensive way to perform a thorough inspection of your vehicle. It's your checklist that gives you immediate feedback on the overall condition of your vehicle. You'll know what's been checked, what's okay, as well as those things that may require future or immediate attention. The multi-point vehicle inspection is one more way to keep your vehicle running great!

418

Scheduled Maintenance Guide

GENUINE
 PARTS & SERVICE

Owner's Member #: _____
 Owner's Serial #: _____

Multi-Point Inspection Report Card as Recommended by Ford Motor Company

Name: _____ Today's Date: _____ / _____ / _____ Mileage: _____

E-Mail Address: _____

SCHEDULED MAINTENANCE ITEMS DUE FOR SERVICES ON THIS VEHICLE		MIS		MIS	
OK	NOT OK	OK	NOT OK	OK	NOT OK
<input type="checkbox"/>	Cabin Air Filter	<input type="checkbox"/>	Oil Filter	<input type="checkbox"/>	Wash/Wax
<input type="checkbox"/>	Engine Air Filter	<input type="checkbox"/>	Spark Plugs	<input type="checkbox"/>	Wash/Wax
<input type="checkbox"/>	Engine Coolant	<input type="checkbox"/>	Tire Rotation	<input type="checkbox"/>	Wash/Wax
<input type="checkbox"/>	Flux Filter	<input type="checkbox"/>	Transmission Fluid	<input type="checkbox"/>	Wash/Wax
<input type="checkbox"/>	Oil Change	<input type="checkbox"/>	Transmission Fluid	<input type="checkbox"/>	Wash/Wax

*This is only a partial list of vehicle maintenance items and is NOT all-inclusive. Please consult your Owner's Manual or visit www.ford.com/owners for vehicle specific maintenance requirements.

CHECK FLUID LEVELS AND FILL		OK	NOT OK
<input type="checkbox"/>	Oil and/or Oil Additives	<input type="checkbox"/>	<input type="checkbox"/>
<input type="checkbox"/>	Wash/Wax	<input type="checkbox"/>	<input type="checkbox"/>
<input type="checkbox"/>	Power Steering	<input type="checkbox"/>	<input type="checkbox"/>
<input type="checkbox"/>	Washer Fluid	<input type="checkbox"/>	<input type="checkbox"/>
<input type="checkbox"/>	Brake Fluid	<input type="checkbox"/>	<input type="checkbox"/>
<input type="checkbox"/>	Windshield Washer	<input type="checkbox"/>	<input type="checkbox"/>

BATTERY

State of Health: _____ %

Condition of _____

Factory spec cold cranking amps: _____

EXHAUST SYSTEM

Exhaust (leaks, damage, loose parts):

Exhaust (rust, holes, leaks, loose parts):

Exhaust (other):

LIGHTS/BLADES/WINDOWS		OK	NOT OK
<input type="checkbox"/>	Operation (front, rear, brake, turn, hazard, fog, reverse, side marker, license plate)	<input type="checkbox"/>	<input type="checkbox"/>
<input type="checkbox"/>	Windshield wiper blades (replace if worn)	<input type="checkbox"/>	<input type="checkbox"/>
<input type="checkbox"/>	Windshield for cracks, chips and pitting	<input type="checkbox"/>	<input type="checkbox"/>
<input type="checkbox"/>	Wipers (replace if worn)	<input type="checkbox"/>	<input type="checkbox"/>
<input type="checkbox"/>	Wax (apply if needed)	<input type="checkbox"/>	<input type="checkbox"/>
<input type="checkbox"/>	Wash/Wax (apply if needed)	<input type="checkbox"/>	<input type="checkbox"/>

TIRE BRAKE WEAR		OK	NOT OK
<input type="checkbox"/>	Front Left	<input type="checkbox"/>	<input type="checkbox"/>
<input type="checkbox"/>	Front Right	<input type="checkbox"/>	<input type="checkbox"/>
<input type="checkbox"/>	Rear Left	<input type="checkbox"/>	<input type="checkbox"/>
<input type="checkbox"/>	Rear Right	<input type="checkbox"/>	<input type="checkbox"/>

Comments: _____

Service Advisor: _____ Customer Signature: _____

Technician: _____

12-XXXXXXXX

NORMAL SCHEDULED MAINTENANCE AND LOG

The following section contains the "Normal Schedule". This schedule is presented at specific mileage (kilometer) intervals with exceptions noted.

Scheduled Maintenance Guide

Miles (x 1,000)	7.5	15	22.5	30	37.5	45	52.5	60	67.5	75
Kilometers (x 1,000)	12	24	36	48	60	72	84	96	108	120
Months	6	12	18	24	30	36	42	48	54	60
Change engine oil and filter	•	•	•	•	•	•	•	•	•	•
Rotate tires, inspect tire wear and measure tread depth. Vehicles equipped with dual rear wheels should only rotate if unusual wear is observed.	•	•	•	•	•	•	•	•	•	•
Inspect the wheels and related components for abnormal noise, wear, looseness or drag	•	•	•	•	•	•	•	•	•	•
Perform multi-point inspection (recommended)	•	•	•	•	•	•	•	•	•	•
Inspect automatic transmission fluid level (if equipped with a dipstick). Consult dealer for requirements.		•		•		•		•		•
Inspect brake pads, shoes, rotors, drums, brake linings, hoses and parking brake		•		•		•		•		•
Inspect engine cooling system concentration and hoses		•		•		•		•		•
Inspect exhaust system and heat shields		•		•		•		•		•
Inspect front axle and U-joints; lubricate if equipped with grease fittings (4WD vehicles)		•		•		•		•		•
Inspect half-shaft boots (if equipped)		•		•		•		•		•
Inspect and lubricate steering linkage, ball joints, suspension, tie-rod ends, driveshaft and U-joints		•		•		•		•		•
Torque the rear U-bolts (Transit Connect)		•		•		•		•		•
Inspect cabin air filter (if equipped)	•		•		•		•		•	

Scheduled Maintenance Guide

Miles (x 1,000)	82.5	90	97.5	105	112.5	120	127.5	135	142.5	150
Kilometers (x 1,000)	132	144	156	168	180	192	204	216	228	240
Months	66	72	78	84	90	96	102	108	114	120
Change engine oil and filter	•	•	•	•	•	•	•	•	•	•
Rotate tires, inspect tire wear and measure tread depth. Vehicles equipped with dual rear wheels should only rotate if unusual wear is observed.	•	•	•	•	•	•	•	•	•	•
Inspect the wheels and related components for abnormal noise, wear, looseness or drag	•	•	•	•	•	•	•	•	•	•
Perform multi-point inspection (recommended)	•	•	•	•	•	•	•	•	•	•
Inspect automatic transmission fluid level (if equipped with a dipstick). Consult dealer for requirements.		•		•		•		•		•
Inspect brake pads, shoes, rotors, drums, brake linings, hoses and parking brake		•		•		•		•		•
Inspect engine cooling system concentration and hoses		•		•		•		•		•
Inspect exhaust system and heat shields		•		•		•		•		•
Inspect front axle and U-joints; lubricate if equipped with grease fittings (4WD vehicles)		•		•		•		•		•
Inspect half-shaft boots (if equipped)		•		•		•		•		•
Inspect and lubricate steering linkage, ball joints, suspension, tie-rod ends, driveshaft and U-joints		•		•		•		•		•
Torque the rear U-bolts (Transit Connect)		•		•		•		•		•
Inspect cabin air filter (if equipped)	•		•		•		•		•	

Scheduled Maintenance Guide

Every 15,000 miles (24,000 km)	Replace cabin air filter (if equipped)
Every 30,000 miles (48,000 km)	Replace climate-controlled seat filter (if equipped)
	Replace engine air filter
	Replace fuel filter (Ranger)
Every 60,000 miles (96,000 km)	Change automatic transmission fluid and filter on TorqShift® transmission. Consult dealer for requirements.
	Replace front wheel bearing grease and grease seal on 4x2 vehicles (if non-sealed bearings are used)
Every 105,000 miles (168,000 km)	Change engine coolant ¹
	Change manual transmission fluid (all trucks except Escape)
	Change rear axle fluid (Dana axles)
	Replace spark plugs
	Inspect accessory drive belt(s) ²
Every 150,000 miles (240,000 km)	Change automatic transmission fluid and filter (filter not required on 6F35, 6F50 and AWF-21 transmissions) except TorqShift® transmission. Consult dealer for requirements.
	Change front axle fluid (4WD vehicles)
	Change manual transmission fluid
	Change rear axle fluid on all rear-wheel drive (RWD) vehicles
	Change transfer case fluid (4WD vehicles)
	Replace accessory drive belt(s) if not replaced within the last 100,000 miles (160,000 km)
	Replace front wheel bearings and seals on 4x2 vehicles (if non-sealed bearings are used)
¹ Initial replacement at 105,000 miles (160,000 km) or 72 months; every 45,000 miles (80,000 km) or 36 months thereafter	
² Perform a follow-up inspection at 120,000 miles (192,000 km)	

Scheduled Maintenance Guide

Maintenance schedule log

<p style="text-align: center;">DEALER VALIDATION:</p> <p>RO#: P&A CODE: DATE: HOURS: MILEAGE:</p>	<p style="text-align: center;">DEALER VALIDATION:</p> <p>RO#: P&A CODE: DATE: HOURS: MILEAGE:</p>
<p style="text-align: center;">DEALER VALIDATION:</p> <p>RO#: P&A CODE: DATE: HOURS: MILEAGE:</p>	<p style="text-align: center;">DEALER VALIDATION:</p> <p>RO#: P&A CODE: DATE: HOURS: MILEAGE:</p>
<p style="text-align: center;">DEALER VALIDATION:</p> <p>RO#: P&A CODE: DATE: HOURS: MILEAGE:</p>	<p style="text-align: center;">DEALER VALIDATION:</p> <p>RO#: P&A CODE: DATE: HOURS: MILEAGE:</p>
<p style="text-align: center;">DEALER VALIDATION:</p> <p>RO#: P&A CODE: DATE: HOURS: MILEAGE:</p>	<p style="text-align: center;">DEALER VALIDATION:</p> <p>RO#: P&A CODE: DATE: HOURS: MILEAGE:</p>
<p style="text-align: center;">DEALER VALIDATION:</p> <p>RO#: P&A CODE: DATE: HOURS: MILEAGE:</p>	<p style="text-align: center;">DEALER VALIDATION:</p> <p>RO#: P&A CODE: DATE: HOURS: MILEAGE:</p>

Scheduled Maintenance Guide

<p style="text-align: center;">DEALER VALIDATION:</p> <p style="text-align: center;">P&A CODE:</p> <p>RO#: HOURS:</p> <p>DATE: MILEAGE:</p>	<p style="text-align: center;">DEALER VALIDATION:</p> <p style="text-align: center;">P&A CODE:</p> <p>RO#: HOURS:</p> <p>DATE: MILEAGE:</p>
<p style="text-align: center;">DEALER VALIDATION:</p> <p style="text-align: center;">P&A CODE:</p> <p>RO#: HOURS:</p> <p>DATE: MILEAGE:</p>	<p style="text-align: center;">DEALER VALIDATION:</p> <p style="text-align: center;">P&A CODE:</p> <p>RO#: HOURS:</p> <p>DATE: MILEAGE:</p>
<p style="text-align: center;">DEALER VALIDATION:</p> <p style="text-align: center;">P&A CODE:</p> <p>RO#: HOURS:</p> <p>DATE: MILEAGE:</p>	<p style="text-align: center;">DEALER VALIDATION:</p> <p style="text-align: center;">P&A CODE:</p> <p>RO#: HOURS:</p> <p>DATE: MILEAGE:</p>
<p style="text-align: center;">DEALER VALIDATION:</p> <p style="text-align: center;">P&A CODE:</p> <p>RO#: HOURS:</p> <p>DATE: MILEAGE:</p>	<p style="text-align: center;">DEALER VALIDATION:</p> <p style="text-align: center;">P&A CODE:</p> <p>RO#: HOURS:</p> <p>DATE: MILEAGE:</p>
<p style="text-align: center;">DEALER VALIDATION:</p> <p style="text-align: center;">P&A CODE:</p> <p>RO#: HOURS:</p> <p>DATE: MILEAGE:</p>	<p style="text-align: center;">DEALER VALIDATION:</p> <p style="text-align: center;">P&A CODE:</p> <p>RO#: HOURS:</p> <p>DATE: MILEAGE:</p>

Scheduled Maintenance Guide

<p style="text-align: center;">DEALER VALIDATION:</p> <p style="text-align: center;">P&A CODE:</p> <p>RO#: HOURS:</p> <p>DATE: MILEAGE:</p>	<p style="text-align: center;">DEALER VALIDATION:</p> <p style="text-align: center;">P&A CODE:</p> <p>RO#: HOURS:</p> <p>DATE: MILEAGE:</p>
<p style="text-align: center;">DEALER VALIDATION:</p> <p style="text-align: center;">P&A CODE:</p> <p>RO#: HOURS:</p> <p>DATE: MILEAGE:</p>	<p style="text-align: center;">DEALER VALIDATION:</p> <p style="text-align: center;">P&A CODE:</p> <p>RO#: HOURS:</p> <p>DATE: MILEAGE:</p>
<p style="text-align: center;">DEALER VALIDATION:</p> <p style="text-align: center;">P&A CODE:</p> <p>RO#: HOURS:</p> <p>DATE: MILEAGE:</p>	<p style="text-align: center;">DEALER VALIDATION:</p> <p style="text-align: center;">P&A CODE:</p> <p>RO#: HOURS:</p> <p>DATE: MILEAGE:</p>
<p style="text-align: center;">DEALER VALIDATION:</p> <p style="text-align: center;">P&A CODE:</p> <p>RO#: HOURS:</p> <p>DATE: MILEAGE:</p>	<p style="text-align: center;">DEALER VALIDATION:</p> <p style="text-align: center;">P&A CODE:</p> <p>RO#: HOURS:</p> <p>DATE: MILEAGE:</p>
<p style="text-align: center;">DEALER VALIDATION:</p> <p style="text-align: center;">P&A CODE:</p> <p>RO#: HOURS:</p> <p>DATE: MILEAGE:</p>	<p style="text-align: center;">DEALER VALIDATION:</p> <p style="text-align: center;">P&A CODE:</p> <p>RO#: HOURS:</p> <p>DATE: MILEAGE:</p>

Scheduled Maintenance Guide

SPECIAL OPERATING CONDITIONS

If you operate your Ford/Lincoln/Mercury vehicle **primarily** in one of the more demanding **Special Operating Conditions** listed below, you will need to have some items maintained more frequently. If you only **occasionally** operate your vehicle under these conditions, it is not necessary to perform the additional maintenance. For specific recommendations, see your Ford or Lincoln Mercury dealership service advisor or technician.

Towing a trailer or using a camper or car-top carrier

Inspect frequently, service as required. – Inspect and lubricate U-joints.
– See axle maintenance items under *Exceptions*.

Every 5,000 miles (8,000 km) – Rotate tires, inspect tires for wear and measure tread depth.
– Inspect the wheels and related components for abnormal noise, wear, looseness or drag.

Every 5,000 miles (8,000 km) or 6 months – Change engine oil and replace oil filter.
– Inspect and lubricate U-joints.

Every 30,000 miles (48,000 km) – Change automatic transmission fluid (not required on 6R80 or TorqShift® transmissions).
– Replace wheel bearing grease and grease seals on 4x2 front wheel bearings (if non-sealed bearings are used).

Every 60,000 miles (96,000 km) – Change transfer case fluid.
– Change manual transmission fluid.

Scheduled Maintenance Guide

Extensive idling and/or low-speed driving for long distances as in heavy commercial use such as delivery, taxi, patrol car or livery

- | | |
|--|--|
| Inspect frequently, service as required | – Replace cabin air filter (if equipped).
– Replace engine air filter. |
| Every 5,000 miles (8,000 km) | – Inspect brake system.
– Rotate tires, inspect tires for wear and measure tread depth.
– Inspect the wheels and related components for abnormal noise, wear, looseness or drag.
– Lubricate control arm and steering ball joints (if equipped with grease fittings). |
| Every 5,000 miles (8,000 km) or 6 months | – Inspect and lubricate U-joints. |
| Every 5,000 miles (8,000 km), 6 months or 200 hours of engine operation | – Change engine oil and replace oil filter. |
| Every 15,000 miles (24,000 km) | – Replace fuel filter (Ranger). |
| Every 30,000 miles (48,000 km) | – Change automatic transmission fluid (not required on 6R80 or TorqShift® transmissions).
– Replace wheel bearing grease and grease seals on 4x2 front wheel bearings (if non-sealed bearings are used). |
| Every 60,000 miles (96,000 km) | – Replace spark plugs.
– Change transfer case fluid. |

Scheduled Maintenance Guide

Operating in dusty conditions such as unpaved or dusty roads

- | | |
|---|--|
| Inspect frequently, service as required | <ul style="list-style-type: none">– Replace cabin air filter (if equipped).– Replace engine air filter. |
| Every 5,000 miles (8,000 km) | <ul style="list-style-type: none">– Rotate tires, inspect tires for wear and measure tread depth.– Inspect the wheels and related components for abnormal noise, wear, looseness or drag. |
| Every 5,000 miles (8,000 km) or 6 months | <ul style="list-style-type: none">– Change engine oil and replace oil filter.– Inspect and lubricate U-joints. |
| Every 15,000 miles (24,000 km) | <ul style="list-style-type: none">– Replace fuel filter (Ranger). |
| Every 30,000 miles (48,000 km) | <ul style="list-style-type: none">– Change automatic transmission fluid (not required on 6R80 or TorqShift® transmissions).– Replace wheel bearing grease and grease seals on 4x2 front wheel bearings (if non-sealed bearings are used). |
| Every 50,000 miles (80,000 km) | <ul style="list-style-type: none">– Change manual transmission fluid.– Change rear axle lubricant (E-450 and F-450/550 only). |
| Every 60,000 miles (96,000 km) | <ul style="list-style-type: none">– Change transfer case fluid. |

Scheduled Maintenance Guide

Off-road operation

- | | |
|---|--|
| Inspect frequently, service as required | <ul style="list-style-type: none">– Replace cabin air filter (if equipped).– Replace engine air filter.– Inspect and lubricate steering linkage ball joints and U-joints (if equipped with grease fittings). |
| Every 5,000 miles (8,000 km) or 6 months | <ul style="list-style-type: none">– Change engine oil and replace oil filter.– Rotate tires, inspect tires for wear and measure tread depth.– Inspect the wheels and related components for abnormal noise, wear, looseness or drag. |
| Every 30,000 miles (48,000 km) | <ul style="list-style-type: none">– Change automatic transmission fluid (not required on 6R80 or TorqShift® transmissions).– Replace wheel bearing grease and grease seals on 4x2 front wheel bearings (if non-sealed bearings are used). |
| Every 50,000 miles (80,000 km) | <ul style="list-style-type: none">– Change manual transmission fluid.– Change rear axle lubricant (E-450 and F-450/550 only). |
| Every 60,000 miles (96,000 km) | <ul style="list-style-type: none">– Change transfer case fluid. |

Exclusive use of E85 (Flex Fuel Vehicles only)

- | | |
|-------------------------|--|
| Every oil change | <ul style="list-style-type: none">– If ran exclusively on E85, fill the fuel tank full with regular unleaded fuel. |
|-------------------------|--|

Scheduled Maintenance Guide

Special operating condition log

<p style="text-align: center;">DEALER VALIDATION:</p> <p style="text-align: center;">P&A CODE:</p> <p>RO#: HOURS:</p> <p>DATE: MILEAGE:</p>	<p style="text-align: center;">DEALER VALIDATION:</p> <p style="text-align: center;">P&A CODE:</p> <p>RO#: HOURS:</p> <p>DATE: MILEAGE:</p>
<p style="text-align: center;">DEALER VALIDATION:</p> <p style="text-align: center;">P&A CODE:</p> <p>RO#: HOURS:</p> <p>DATE: MILEAGE:</p>	<p style="text-align: center;">DEALER VALIDATION:</p> <p style="text-align: center;">P&A CODE:</p> <p>RO#: HOURS:</p> <p>DATE: MILEAGE:</p>
<p style="text-align: center;">DEALER VALIDATION:</p> <p style="text-align: center;">P&A CODE:</p> <p>RO#: HOURS:</p> <p>DATE: MILEAGE:</p>	<p style="text-align: center;">DEALER VALIDATION:</p> <p style="text-align: center;">P&A CODE:</p> <p>RO#: HOURS:</p> <p>DATE: MILEAGE:</p>
<p style="text-align: center;">DEALER VALIDATION:</p> <p style="text-align: center;">P&A CODE:</p> <p>RO#: HOURS:</p> <p>DATE: MILEAGE:</p>	<p style="text-align: center;">DEALER VALIDATION:</p> <p style="text-align: center;">P&A CODE:</p> <p>RO#: HOURS:</p> <p>DATE: MILEAGE:</p>
<p style="text-align: center;">DEALER VALIDATION:</p> <p style="text-align: center;">P&A CODE:</p> <p>RO#: HOURS:</p> <p>DATE: MILEAGE:</p>	<p style="text-align: center;">DEALER VALIDATION:</p> <p style="text-align: center;">P&A CODE:</p> <p>RO#: HOURS:</p> <p>DATE: MILEAGE:</p>

Scheduled Maintenance Guide

<p style="text-align: center;">DEALER VALIDATION:</p> <p style="text-align: center;">P&A CODE:</p> <p>RO#: HOURS:</p> <p>DATE: MILEAGE:</p>	<p style="text-align: center;">DEALER VALIDATION:</p> <p style="text-align: center;">P&A CODE:</p> <p>RO#: HOURS:</p> <p>DATE: MILEAGE:</p>
<p style="text-align: center;">DEALER VALIDATION:</p> <p style="text-align: center;">P&A CODE:</p> <p>RO#: HOURS:</p> <p>DATE: MILEAGE:</p>	<p style="text-align: center;">DEALER VALIDATION:</p> <p style="text-align: center;">P&A CODE:</p> <p>RO#: HOURS:</p> <p>DATE: MILEAGE:</p>
<p style="text-align: center;">DEALER VALIDATION:</p> <p style="text-align: center;">P&A CODE:</p> <p>RO#: HOURS:</p> <p>DATE: MILEAGE:</p>	<p style="text-align: center;">DEALER VALIDATION:</p> <p style="text-align: center;">P&A CODE:</p> <p>RO#: HOURS:</p> <p>DATE: MILEAGE:</p>
<p style="text-align: center;">DEALER VALIDATION:</p> <p style="text-align: center;">P&A CODE:</p> <p>RO#: HOURS:</p> <p>DATE: MILEAGE:</p>	<p style="text-align: center;">DEALER VALIDATION:</p> <p style="text-align: center;">P&A CODE:</p> <p>RO#: HOURS:</p> <p>DATE: MILEAGE:</p>
<p style="text-align: center;">DEALER VALIDATION:</p> <p style="text-align: center;">P&A CODE:</p> <p>RO#: HOURS:</p> <p>DATE: MILEAGE:</p>	<p style="text-align: center;">DEALER VALIDATION:</p> <p style="text-align: center;">P&A CODE:</p> <p>RO#: HOURS:</p> <p>DATE: MILEAGE:</p>

Scheduled Maintenance Guide

EXCEPTIONS

In addition, there are several exceptions to the Normal Schedule. They are listed below:

Normal Vehicle Axle Maintenance

- Rear axles and power take-off (PTO) units containing synthetic lubricant and light duty trucks equipped with Ford-design axles are lubricated for life. These lubricants are not to be checked or changed unless a leak is suspected, service is required or the axle assembly has been submerged in water. The axle and PTO lubricant should be changed anytime the axle and PTO have been submerged in water. During extended trailer tow operation above 70°F (21°C) ambient and wide open throttle for extended periods above 45 mph (72 km/h), non-synthetic rear axle lubricants should be replaced every 3,000 miles (4,800 km) or 3 months, whichever occurs first. The 3,000 mile (4,800 km) lubricant change interval may be waived if the axle was filled with 75W140 synthetic gear lubricant meeting Ford specification WSL-M2C192-A, part number FITZ-19580-B or equivalent. Add friction modifier XL-3 (EST-M2C118-A) or equivalent for complete refill of Traction-Lok rear axles (refer to *Maintenance product and specifications* in the *Maintenance and Specifications* chapter for details). The axle lubricant should be changed anytime an axle has been submerged in water.

Police/Taxi/Livery Vehicle Axle Maintenance

- Replace rear axle lubricant every 100,000 miles (160,000 km). Rear axle lubricant change may be waived if the axle was filled with 75W140 synthetic gear lubricant meeting Ford specification WSL-M2C192-A, part number FITZ-19580-B or equivalent. Add four ounces (118 mL) of additive friction modifier XL-3 (EST-M2C118-A) or equivalent for complete refill of Traction-Lok rear axles. The axle lubricant should be changed anytime the axle has been submerged in water.

E-450 and F-450/550 Axle Maintenance

- Replace rear axle lubricant every 100,000 miles (160,000 km) under normal driving conditions on all E-450 and F-450/550 applications. For E-450 and F-450/550 vehicles operated at or near maximum Gross Vehicle Weights, the rear axle lubricant should be replaced every 50,000 miles (80,000 km). In addition, this 50,000 mile (80,000 km) schedule should be observed when the vehicles are operated under the Special Operating Conditions.

California Fuel Filter Replacement

- If vehicle is registered in California, the California Air Resources Board has determined that the failure to perform this maintenance item will not nullify the emission warranty or limit recall liability prior to the completion of the vehicle's useful life. Ford Motor Company, however, urges you to have all recommended maintenance services performed at the specified intervals and to record all vehicle service.

Class A Motorhome

- Every two years - Change brake fluid

Scheduled Maintenance Guide

Hot Climate Oil Change Intervals

- If operating conditions are normal and you drive your Ford, Lincoln or Mercury vehicle under typical, everyday conditions **and** you are using an API performance category oil of SL or later (for example SM, etc.) then you can follow the 7,500 mile (12,000 km) normal service oil change intervals schedule. Vehicles operating in the Middle East, North Africa, Sub-Saharan Africa or locations with similar climates must follow the oil change interval of 3,000 mile (5,000 km) if the owner is using oils defined by the American Petroleum Institute (API) performance category of API SK or earlier (for example SJ, etc.).

Engine Air Filter & Cabin Air Filter Replacement

- Engine air filter and cabin air filter life is dependent on exposure to dusty and dirty conditions. Vehicles operated in these conditions will require frequent inspection and replacement of the engine air filter and cabin air filter.

COOLANT CHANGE RECORD

Engine coolant

- 6 years or 105,000 miles (168,000 km) - change coolant (whichever comes first).
- After initial change - change coolant every 3 years or 45,000 miles (72,000 km).

Scheduled Maintenance Guide

Engine coolant change log

<p style="text-align: center;">DEALER VALIDATION:</p> <p style="text-align: center;">P&A CODE:</p> <p>RO#: HOURS:</p> <p>DATE: MILEAGE:</p>	<p style="text-align: center;">DEALER VALIDATION:</p> <p style="text-align: center;">P&A CODE:</p> <p>RO#: HOURS:</p> <p>DATE: MILEAGE:</p>
<p style="text-align: center;">DEALER VALIDATION:</p> <p style="text-align: center;">P&A CODE:</p> <p>RO#: HOURS:</p> <p>DATE: MILEAGE:</p>	<p style="text-align: center;">DEALER VALIDATION:</p> <p style="text-align: center;">P&A CODE:</p> <p>RO#: HOURS:</p> <p>DATE: MILEAGE:</p>
<p style="text-align: center;">DEALER VALIDATION:</p> <p style="text-align: center;">P&A CODE:</p> <p>RO#: HOURS:</p> <p>DATE: MILEAGE:</p>	<p style="text-align: center;">DEALER VALIDATION:</p> <p style="text-align: center;">P&A CODE:</p> <p>RO#: HOURS:</p> <p>DATE: MILEAGE:</p>
<p style="text-align: center;">DEALER VALIDATION:</p> <p style="text-align: center;">P&A CODE:</p> <p>RO#: HOURS:</p> <p>DATE: MILEAGE:</p>	<p style="text-align: center;">DEALER VALIDATION:</p> <p style="text-align: center;">P&A CODE:</p> <p>RO#: HOURS:</p> <p>DATE: MILEAGE:</p>
<p style="text-align: center;">DEALER VALIDATION:</p> <p style="text-align: center;">P&A CODE:</p> <p>RO#: HOURS:</p> <p>DATE: MILEAGE:</p>	<p style="text-align: center;">DEALER VALIDATION:</p> <p style="text-align: center;">P&A CODE:</p> <p>RO#: HOURS:</p> <p>DATE: MILEAGE:</p>

Index

A

Accessory delay103
AdvanceTrac268
Air cleaner filter394–395, 399
Air conditioning78, 81
 manual heating and air
 conditioning system78
Airbag supplemental restraint
system176, 180, 182
 and child safety seats177
 description176, 180, 182
 disposal190
 driver airbag178, 181, 183
 indicator light185
 operation178, 181, 183
 passenger airbag178, 181, 183
 passenger deactivation
 switch186
 side airbag180
Ambulance packages7
Antifreeze
(see Engine coolant)370
Anti-lock brake system
(see Brakes)265
Anti-theft system146, 148
 arming the system147, 149
 disarming a triggered
 system149
 triggering149
Audio system
(see Radio)60, 62
Automatic transmission283
 driving an automatic
 overdrive281
 fluid, adding391
 fluid, checking391
 fluid, refill capacities400
 Selectshift (SST)286

Auxiliary Input Jack69
Auxiliary power point100
Axle
 refill capacities400

B

Battery368
 acid, treating emergencies368
 jumping a disabled battery340
 maintenance-free368
 replacement, specifications ...399
 servicing368
Bed extender123
Belt-Minder®172
Booster seats207
Brakes265
 anti-lock265
 anti-lock brake system (ABS)
 warning light266
 fluid, checking and adding ...391
 fluid, refill capacities400
 parking266
 shift interlock279
 trailer251
Bulbs91

C

Capacities for refilling fluids400
Car2U® Home Automation
System115
Cassette tape player60
Cell phone use10
Changing a tire323
Child safety seats195
 attaching with tether straps ..202
 in front seat195, 202

435

Index

- in rear seat195, 202
 - LATCH202
 - Child safety seats - booster seats207
 - Cleaning your vehicle
 - engine compartment354
 - instrument panel356–357
 - interior357
 - plastic parts355
 - safety belts357
 - washing352
 - waxing353
 - wheels353
 - wiper blades355
 - Climate control (see Air conditioning or Heating)78, 81
 - Clock adjust
 - AM/FM/CD64
 - Compass, electronic
 - set zone adjustment27
 - Console99
 - overhead99
 - Controls
 - power seat156
 - steering column111
 - Coolant
 - checking and adding370
 - refill capacities374, 400
 - Cruise control (see Speed control)109
 - Customer Assistance311
 - Ford accessories for your vehicle360
 - Ford Extended Service Plan411, 414
 - Getting assistance outside the U.S. and Canada349
 - Getting roadside assistance ...311
 - Getting the service you need345
 - Ordering additional owner's literature351
 - Utilizing the Mediation/Arbitration Program349
- ### D
- Daytime running lamps (see Lamps)88
 - Defrost
 - rear window and rearview mirrors81
 - windshield81
 - Dipstick
 - automatic transmission fluid391
 - engine oil366
 - Driving under special conditions288, 301, 304
 - sand303
 - snow and ice305
 - through water303, 307
- ### E
- Electronic message center ...22, 40
 - Emergencies, roadside
 - jump-starting340
 - Emergency Flashers312
 - Emission control system387
 - Engine404
 - cleaning354
 - coolant370
 - diesel6
 - fail-safe cooling374
 - idle speed control368

Index

- refill capacities400
- service points362–364
- Engine block heater263
- Engine oil366
 - checking and adding366
 - dipstick366
 - filter, specifications367, 399
 - recommendations367
 - refill capacities400
- Event data recording8
- Exhaust fumes262
- F**
- Fail safe cooling374
- Fleet MyKey programming126
- Flexible Fuel Vehicle (FFV)377
- Floor mats120
- Fluid capacities400
- Fog lamps87
- Four-Wheel Drive vehicles293
 - driving off road299
 - electronic shift294, 298
 - indicator light295
 - lever operated shift295
 - manual locking hubs293
 - preparing to drive your vehicle278
- Fuel377
 - calculating fuel economy25, 384
 - cap380
 - capacity400
 - choosing the right fuel381
 - detergent in fuel383
 - filling your vehicle with fuel377, 380, 384
 - filter, specifications377, 399
 - fuel pump shut-off313
 - improving fuel economy384
 - octane rating382, 404
 - quality382
 - running out of fuel383
 - safety information relating to automotive fuels377
- Fuel - flex fuel vehicle (FFV)377, 381–382
- Fuses313–314
- G**
- Garage door opener115
- Gas cap (see Fuel cap)380
- Gas mileage (see Fuel economy)384
- Gauges21
- H**
- Hazard flashers312
- Headlamps86
 - aiming88–89
 - autolamp system86
 - daytime running lights88
 - flash to pass87
 - high beam87
 - replacing bulbs92
 - turning on and off86
- Heating
 - heating and air conditioning system78, 81
- Hill descent mode275
- Hill launch assist287
- Hood362

Index

I

- Ignition259, 404
- Illuminated visor mirror98
- Infant seats
(see Safety seats)195
- Inspection/maintenance (I/M)
testing389
- Instrument panel
 - cleaning356–357
 - cluster14
 - lighting up panel and
interior88

J

- Jack323
 - positioning323
 - storage323
- Jump-starting your vehicle340

K

- Keyless entry system
 - autolock134
 - keypad145
 - locking and unlocking doors ..146
 - programming entry code145
- Keys126, 147
 - positions of the ignition259

L

- Lamps
 - autolamp system86
 - daytime running light88
 - fog lamps87
 - headlamps86
 - headlamps, flash to pass87
 - instrument panel, dimming88

- interior lamps90
 - replacing bulbs92, 94–96
- LATCH anchors202
- Lights, warning and indicator14
 - anti-lock brakes (ABS)266
- Load limits239
- Loading instructions246
- Locks
 - autolock134
 - childproof138
 - doors134
- Lug nuts339
- Lumbar support, seats157–158

M

- Manual transmission
 - fluid capacities400
- Message center22–23, 40
 - english/metric button27
 - system check button27
 - warning messages29, 48
- Mirrors104
 - automatic dimming rearview
mirror104
 - fold away105, 107
 - heated81
 - programmable memory140
 - side view mirrors (power)104
 - signal108
- Moon roof114
- Motorcraft® parts399
- MyKey126

N

- Navigation system77

Index

O

- Octane rating382
- Oil (see Engine oil)366

P

- Parental MyKey programming126
- Parking brake266
- Parts (see Motorcraft® parts)399
- Pedals (see Power adjustable foot pedals)108
- Power adjustable foot pedals ...108
- Power distribution box (see Fuses)319
- Power door locks134
- Power mirrors104
- Power point100
- Power steering276
 - fluid, checking and adding390
 - fluid, refill capacity400
- Power Windows102
- Preparing to drive your vehicle278

R

- Radio60, 62
- Rear-view camera system291
- Relays313
- Remote entry system138–139
 - illuminated entry142
 - locking/unlocking doors139–140
 - Remote start143

- replacement/additional transmitters142
- replacing the batteries141
- Remote start143
- Remote start climate operation85
- Reverse sensing system289
- Roadside assistance311

S

- Safety belts (see Safety restraints)166–170, 172
- Safety Canopy181–182
- Safety defects, reporting351
- Safety restraints166–170, 172
 - Belt-Minder®172
 - extension assembly171
 - for adults167–170
 - for children190
 - warning light and chime172
- Safety restraints - LATCH anchors202
- Safety seats for children195
- Safety Compliance Certification Label405
- Satellite Radio Information74
- Scheduled Maintenance Guide
 - Normal Scheduled Maintenance and Log419
 - What Maintenance Schedule Should You Follow?417
- Seats150
 - child safety seats195
 - cleaning358
 - climate control81, 159
 - easy access/easyout feature ..161
 - memory seat140, 160

439

Index

- SecuriCode keyless entry system145
- SecuriLock passive anti-theft system146–147
- Servicing your vehicle361
- Setting the clock
 - AM/FM/CD64
- Snowplowing7, 307–309
- SOS Post Crash Alert185
- Spark plugs, specifications399, 404
- Special notice7
 - ambulance conversions7
 - diesel-powered vehicles6
 - four-wheel drive vehicles309
 - utility-type vehicles7
- Speed control109
- Starting a flex fuel vehicle262
- Starting your vehicle259–262
 - jump starting340
- Steering wheel
 - controls111
 - tilting98
- SYNC®77
- T**
- Tailgate121
- Tilt steering wheel98
- Tire Pressure Monitoring System (TPMS)
 - Tires, Wheels and Loading232
- Tires214–216, 323
 - alignment224
 - care220
 - changing323, 326, 329
 - checking the pressure219
- 440
- inflating217
- label231
- replacing222
- rotating225
- safety practices223
- sidewall information227
- snow tires and chains238
- spare tire324
- terminology216
- tire grades215
- treadwear215, 221
- Towing247
 - recreational towing258
- Trailer Brake
 - Controller-Integrated251
 - trailer towing247
 - wrecker343
- Traction control267
- Trailer Brake
 - Controller-Integrated251
- Trailer sway control275
- Transfer case
 - fluid checking394
- Transmission281
 - brake-shift interlock (BSI)279
 - fluid, checking and adding (automatic)391
 - fluid, refill capacities400
- Turn signal90
- U**
- Universal garage door opener ..115
- Upfitter controls112
- USB port71

Index

V		Washer fluid365	
Vehicle Identification Number (VIN)	406	Water, Driving through307	
Vehicle loading	239	Windows	
Ventilating your vehicle	263	power	102
W		Windshield washer fluid and wipers	97
Warning lights (see Lights)	14	checking and adding fluid	365
		replacing wiper blades	365
		Wrecker towing	343